

Section 19

Push Buttons and Operator Interface









Selection Guide	19-2
Push Buttons and Pilot Lights	19-2
Control Stations	19-4
Tower Lights and Beacons	19-5
Pendant Stations	19-7
22 and 30 mm Most Common Complete Operators	19-8
XB4–XB5 Common Operators, Complete with Contact Blocks	19-8
Type K, SK Common Operators, Complete with Contact Blocks	19-9
Compact Pilot Lights	19-10
Type XVL	19-10
Type J Compact Pilot Lights	19-11
16 mm Push Buttons	19-12
XB6 Complete Devices	19-12
XB6E Monolithic Push Buttons	19-21
22 mm Push Buttons	19-24
XB4 Complete Devices	19-24
XB5 Complete Devices	19-43
XB5R Plastic and XB4R Metal Wireless, Batteryless Push Buttons	19-63
XB5S Biometric Switches	19-66
XB7 Push Buttons	19-68
30 mm Push Buttons	19-72
30 mm Push Buttons (Square)	19-102
KX Square Multifunction Operators	19-102
Control Stations and Enclosures	19-107
XAL 22 mm Control Stations	19-107
XAP 22 mm Enclosures and Accessories	19-108
9001B Standard Duty Control Stations	19-110
30 mm Control Stations and Enclosures	19-111
Type B Standard Duty Control Stations—Replacement Parts	19-111
30 mm Enclosures	19-112
9001KY/SKY Control Stations	19-112
Point of Purchase—PoP Products	19-114
Tower Lights and Beacons	19-115
Pendant Stations	19-125
Type BW Pendant Stations	19-127
XAC Standard Duty Pistol Grips, Enclosures, Contact Blocks	19-128
Type XACA Worksheet	19-131
Application and Ordering Information	19-132
Foot Switches	19-134
Rotary Cam Switches	19-136

Push Button and Pilot Light Selection Guide

Family	XVL	Type J	XB6	XB6E
	 XVLA1**			
	 XVLA2**			
	 XVLA3**			
Type of Product	Mini Pilot Light	Compact Pilot Light	16 mm Push Button (plastic)	16mm Push Button (plastic)
Mounting Hole Diameter	8 mm / 12 mm	17.5 mm (0.68 in)	16.2 mm	16.2 mm
Approvals	UL Recognized File E164353, CCN NKCR CSA File LR44078, Class 3211-03	UL File E78403, CCN NKCR CSA File LR25490, Class 3211-03	UL File E164353, CCN NKCR CSA File LR44087, Class 3211-03	UL File E164353, CCN NKCR CSA File LR44087, Class 3211-03
Conforming to Standards	CE Marked RoHS Compliant IEC337-2 NF C 63-140 VDE 0660-200	CE Marked RoHS Compliant	CE Marked RoHS Compliant EN/IEC 60947-1, EN/IEC 60947-5-1, EN/IEC 60947-5-5 EN/IEC 60204-1 and EN/ISO 13850: 2006 (trigger action and mechanical latching Emergency Stop push buttons) JIS C 4520 and 853 UL 508 and CSA C22-2 no. 14 Gost CCC	CE Marked RoHS Compliant EN/IEC 60947-1, EN/IEC 60947-5-1, EN/IEC 60947-5-5 EN/IEC 60947-5-5 EN/IEC 60204-1 and EN/ISO 13850: 2006 (trigger action and mechanical latching Emergency Stop push buttons) UL 508 and CSA C22-2 no. 14 CCC
Degree of Protection	IP40 (IP65 with seal)	NEMA 4, 13	IP65 NEMA 1, 4, 4X, 12	IP65 NEMA 4, 4X, 13
Operating Temperature F° (C°)	-13 to 158 (-25 to 70)	104 (40) Max	-13 to 158 (-25 to 70)	14 to 151 (-10 to 55)
Storage Temperature F° (C°)	-40 to 158 (-40 to 70)		-40 to 158 (-40 to 70)	-40 to 158 (-40 to 70)
Electric Shock Protection	—	—	—	—
Electrical Consumption	—	—	—	—
LED	25 mA	—	6-30 Vac/Vdc: 15 mA 48-120 Vac: 20 mA	10 mA
Rated Operational Characteristics	—	—	AC-15; B300 Ue = 240 Vac and Ie = 1.5A Ue = 120 Vac and Ie = 3 A Continuous 5 A	AC-13; Ue = 240 Vac and Ie = 0.7A Ue = 120 Vac and Ie = 1A Continuous 5 A
	—	—	DC-13; R300 Ue = 250 Vdc and Ie = 0.1 A Ue = 125 Vdc and Ie = 0.22 A	DC-13; Ue = 125 Vdc and Ie = 0.15 A Ue = 24 Vdc and Ie = 0.7 A
Connection Type	XVLA1** and XVLA2** = 2.8mm x 0.5mm Faston XVLA3** = Screw Terminals	Screw Terminal —	Quick Connect/ Solder Tabs 0.11 x 0.02 in. (2.8 x 0.5 mm)	Quick Connect/ Solder Tabs 0.11 x 0.02 in. (2.8 x 0.5 mm)
Cable Size	1 x 1.5 mm ² max.	2 x 14 AWG (copper only)	—	—
Digest Location	XVL, page 19-10	Type J, page 19-11	XB6, page 19-12	XB6E, page 19-21

Push Button Selection Guide

Family	XB4	XB5	XB7	9001K	9001SK	9001KX
						
Type of Product	*22 mm Push Button (metal)	**22 mm Push Button (plastic)	***22mm Push Button (plastic)	****30 mm Push Button (metal)	****30 mm Push Button (plastic)	****30 mm Push Button (metal, square)
Mounting Hole Diameter	22.5 mm	22.5 mm	22.5 mm	31 mm (1.22 in)	31 mm (1.22 in)	31 mm (1.22 in)
Approvals	UL Listed File E164353, CCN NKCR UL Recognized File E164353, CCN NKCR2	UL Listed File E164353, CCN NKCR UL Recognized File E164353, CCN NKCR2	UL File E164353, CCN NKCR	UL File E78403, CCN NKCR	UL File E78403, CCN NKCR	UL File E78403, CCN NKCR
	CSA File LR44087, Class 3211-03	CSA File LR44087, Class 3211-03	CSA File LR44087-122 Class 3211-03	CSA File LR25490, Class 3211-03	CSA File LR25490, Class 3211-03	CSA File LR25490, Class 3211-03
Conforming to Standards	CE Marked RoHS Compliant	CE Marked RoHS Compliant	CE Marked RoHS Compliant	CE Marked RoHS Compliant	CE Marked RoHS Compliant	CE Marked RoHS Compliant
	EN/IEC 60947-1, EN/IEC 60947-5-1, EN/IEC 60947-5-4, EN/IEC 60947-5-5	EN/IEC 60947-1, EN/IEC 60947-5-1, EN/IEC 60947-5-4, EN/IEC 60947-5-5	EN/IEC 60947-1, EN/IEC 60947-5-1 for push buttons, pilot lights, illuminated push buttons and selector switches EN/IEC 60947-1, EN/IEC 60947-5-1, EN/IEC 60947-5-5,	EN/IEC 60947-1	EN/IEC 60947-1	
	EN/IEC 60204-1 and EN/ISO 13850:2006 (trigger action and mechanical latching emergency stop push buttons)	EN/IEC 60204-1 and EN/ISO 13850:2006 (trigger action and mechanical latching emergency stop push button).	EN/IEC 60204-1 and EN/ISO 13850 for Emergency Stop trigger action push buttons	EN/IEC60947-5-1	EN/IEC60947-5-1	
	EN/IEC 60364-5-53 (emergency switching of mechanical latching push buttons)	EN/IEC 60364-5-53 (emergency switching of mechanical latching push buttons)		EN/IEC60947-5-4	EN/IEC60947-5-4	
	—	EN81-1 (emergency stop trigger action and mechanical latching push buttons with mechanical state indicator)				
	JIS C 4520	JIS C 4520		JIS C 4520 and 852	JIS C 4520 and 852	
	UL 508	UL 508	UL 508	UL 508	UL 508	
	CSA C22.2 No.14	CSA C22.2 No.14	CSA C22.2 No.14	CSA C22.2 No.14	CSA C22.2 No.14	
	GOST	GOST				
	CCC	CCC	CCC			
Degree of Protection	IP65	IP65	IP54, IP65	IP65	IP65	IP66
	IP66 for booted	IP66 for booted	—	—	—	—
	NEMA 1, 2, 3, 4, 4X, 12, 13	NEMA 1, 2, 3, 3R, 4, 4X, 12, 13	NEMA 3, 4, 12	NEMA 1, 2, 3, 3R, 4, 12, 13	NEMA 1, 2, 3, 3R, 4, 4X, 12, 13	NEMA 1, 2, 3, 3R, 4, 12, 13
Operating Temperature F° (C°)	-13 to 158 (-40 to 70) LED and Neon -13 to 131 (-25 to 55) Incandescent	-13 to 158 (-40 to 70) LED and Neon -13 to 131 (-25 to 55) Incandescent	-13 to 158 (-25 to 70)	-22 to 140 (-30 to 60)	-22 to 140 (-30 to 60)	-22 to 140 (-30 to 60)
Storage Temperature F° (C°)	-40 to 158 (-40 to 70)	-40 to 158 (-40 to 70)	-40 to 158 (-40 to 70)	-40 to 158 (-40 to 70)	-40 to 158 (-40 to 70)	-40 to 158 (-40 to 70)
Electric Shock Protection	Class I	Class I	—	Class II	Class II	Class II
Electrical Consumption						
	24 Vac/Vdc: 18 mA 120 Vac: 14 mA	24 Vac/Vdc: 18 mA 120 Vac: 14 mA	Illuminated Push Buttons: 24V - 18mA 120V - 12mA 230V - 22mA Pilot Lights 24V - 20mA 120V - 18mA 230V - 16mA	Incandescent and LED bulbs. For ratings, see Standard Light Modules, page 19-91.	Incandescent and LED bulbs. For ratings, see Standard Light Modules, page 19-91.	—
	240 Vac: 14 mA	240 Vac: 14 mA				
Rated Operational Characteristics	AC-15; B600 Ue = 600 Vac and Ie = 1.2 A Ue = 240 Vac and Ie = 3 A Ue = 120 Vac and Ie = 6 A Continuous 10 A	AC-15; B600 Ue = 600 Vac and Ie = 1.2 A Ue = 240 Vac and Ie = 3 A Ue = 120 Vac and Ie = 6 A Continuous 10 A	AC-14; D300 Ue = 240 Vac and Ie = 0.3A Ue = 120 Vac and Ie = 0.6A Continuous 4 A	AC-15; A600 Continuous 10 A	AC-15; A600 Continuous 10 A	AC-15; A600 Continuous 10 A
	DC-13; Q600 Ue = 600 Vdc and Ie = 0.1 A Ue = 250 Vdc and Ie = 0.27 A Ue = 125 Vdc and Ie = 0.55 A	DC-13; Q600 Ue = 600 Vdc and Ie = 0.1 A Ue = 250Vdc and Ie = 0.27 A Ue = 125 Vdc and Ie = 0.55 A	DC-13; R300 Ue = 250 Vdc and Ie = 0.1A Ue = 125 Vdc and Ie = 0.22A	DC-13; Q600 Ue = 600 Vdc and Ie = 0.1 A Ue = 250 Vdc and Ie = 0.27 A Ue = 125 Vdc and Ie = 0.55 A	DC-13; Q600 Ue = 600 Vdc and Ie = 0.1 A Ue = 250 Vdc and Ie = 0.27 A Ue = 125 Vdc and Ie = 0.55 A	DC-13; Q600 Ue = 600 Vdc and Ie = 0.1 A Ue = 250 Vdc and Ie = 0.27 A Ue = 125 Vdc and Ie = 0.55 A
Connection Type	IP20 Fingersafe Screw or Spring Terminal Screw Terminal:	Spring Terminal:	Screw and captive clamp terminal connections Faston clip connections (pilot lights)	IP20 Fingersafe Screw Terminal		
Cable Size	1 x 24 AWG (0.22 mm ²) min. 2 x 14 AWG (2.5 mm ²) max. 2 x 16 AWG (1.5 mm ²) max.	1 x 24 AWG (0.22 mm ²) min. 2 x 14 AWG (2.5 mm ²) max. 2 x 16 AWG (1.5 mm ²) max.		1 x 24 AWG (0.22 mm ²) min. 2 x 16 AWG (1.5 mm ²) max	1 x 24 AWG (0.22 mm ²) min. 2 x 16 AWG (1.5 mm ²) max	1 x 24 AWG (0.22 mm ²) min. 2 x 16 AWG (1.5 mm ²) max
Digest Location	XB4, page 19-24	XB5, page 19-43	XB7, page 19-68	Type K, page 19-72	Type SK, page 19-82	KX, page 19-102

Control Station Selection Guide

Family	XAL	XAP	9001B	9001KY/SKY	Point of Purchase (PoP)
--------	-----	-----	-------	------------	-------------------------



XALD02



XAPA1100

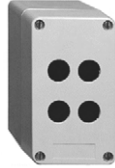

XAPA1104



NEMA 1
Surface Mounting
9001BG**



NEMA 1
Flush Mounting
9001BF**



9001KYSS3



9001KY3



NEMA 4
9001BW**



NEMA 7 and 9
9001BR**



9001KYAF3



9001SKY2



New!

Type of Product/ Material	XALD—Polycarbonate XALK—Polycarbonate	XAPA—glass filled polyester XAPG—die cast zinc XAPE—anodized aluminum	9001BG—plastic cover 9001BF—stainless steel 9001BW—die cast zinc 9001BR—cast aluminum	9001KYAF—sheet steel 9001KYSS—stainless steel 9001KY—die cast zinc 9001KZ—die cast zinc 9001SKY—Polyester	Push Buttons, Pendants, Tower lights, Relays
Number of holes	1 to 3	0 to 16	1 to 3	1 to 6	
Type of Operators	XB5 (22mm)	XB5 (22mm)	Built in	9001K/SK (30mm)	
Available without Operators	Yes	Yes	No	Yes	
Available with Operators	Yes	No	Yes	Yes	
Approvals	UL File E164353 CCN NKCR CSA File LR 44087 Class 3211-03	UL File E164353 CCN NKCR CSA File LR 44087 Class 3211-03	UL File E78403 CCN NKCR CSA File LR 25490 Class 3211-03	UL File E78403 CCN NKCR CSA File LR 25490 Class 3211-03	UL, CSA, CE, ROHS
Conforming to Standards	CE Marked	CE Marked	CE Marked	CE Marked	
	EN/IEC 60947-1, EN/IEC 60947-5-1, EN/IEC 60947-5-4,	EN/IEC 60947-1, EN/IEC 60947-5-1, EN/IEC 60947-5-4,	EN/IEC 60947-1, EN/IEC 60947-5-1, EN/IEC 60947-5-4,	EN/IEC 60947-1, EN/IEC 60947-5-1, EN/IEC 60947-5-4,	
	JIS C 4520	JIS C 4520	JIS C 4520	JIS C 4520	
	UL 508	UL 508	UL 508	UL 508	
Degree of Protection	1, 4, 4X, 13 IP65 IP66 - Booted	XAPA - 4, 4X, 12, IP65 XAPG - 4, 12, IP65 XAPE - 4, 4X, 12, IP65	9001BG - 1 9001BF - 1 9001BW - 4 9001BR - 7, 9	9001KYAF - 3, 13 9001KYSS - 3, 4, 4X, 13 9001KY - 3, 4, 13 9001KZ - 3, 13 9001SKY - 3, 4, 4X, 13	
Operating Temperature F° (C°)	-13 to 158 (-25 to 70)	-13 to 158 (-25 to 70)			
Storage Temperature F° (C°)	-40 to 158 (-10 to 70)	-40 to 158 (-10 to 70)			
Cable Entry	No. 13 knock out	XAPA—undrilled XAPG—Tapped 3/4NPT XAPE—flush mount (n/a)	9001BG—1/2 & 3/4 knockout 9001BF—N/A 9001BW—1/2-14NPT 9001BR—1/2-14NPT	9001KYAF—customer provided 9001KYSS—G conduit hub 9001KY—customer provided 9001KZ—1/2 & 3/4 knockout 9001SKY—G conduit hub	
Digest Location	XAL, page 19-107	XAP, page 19-107	9001B, page 19-110	KY/SKY, page 19-112	PoP Products, page 19-114

Tower Lights and Beacons Selection Guide (1 of 2)

Family	XVB L	XVB C
--------	-------	-------



Type of Product	Beacon	Tower Light
Diameter	70mm	70mm
Features	Product for Customer Configuration	Product for Customer Configuration
Approvals	UL File E164353 CCN NKCR CSA File LR 44087 Class 3211 03	UL File E164353 CCN NKCR CSA File LR 44087 Class 3211 03
Conforming to Standards	CE Marked IEC/EN 60947-5-1 UL 508 CSA 22.2 No 14	CE Marked IEC/EN 60947-5-1 UL 508 CSA 22.2 No 14
Degree of Protection	IP65	IP65
Operating Temperature F° (C°)	-13 to 122 (-25 to 50)	-13 to 122 (-25 to 50)
Storage Temperature F° (C°)	-40 to 158 (-40 to 70)	-40 to 158 (-40 to 70)
Light Source	LED / Incandescent	LED / Incandescent
Electrical Consumption		
LED Steady	24 Vac/dc: < 30 mA	24 Vac/dc: < 30 mA
	120-230 Vac: < 30 mA	120-230 Vac: < 30 mA
LED Flashing with Buzzer	24 Vac/dc: < 40 mA	24 Vac/dc: < 40 mA
	120-230 Vac: < 15mA 1 Hz (1 flash per second)	120-230 Vac: < 15mA 1 Hz (1 flash per second)
Strobe (Energized)	24 Vdc: 5 Joules unit: < 430 mA; 10 J unit: < 850 mA	24 Vdc: 5 Joules unit: < 430 mA; 10 J unit: < 850 mA
	120 Vac: 5 Joules unit: < 130 mA; 10 J unit: < 260 mA	120 Vac: 5 Joules unit: < 130 mA; 10 J unit: < 260 mA
	230 Vac: 5 Joules unit: < 105 mA; 10 J unit: < 210 mA	230 Vac: 5 Joules unit: < 105 mA; 10 J unit: < 210 mA
	1 Hz (1 flash per second)	1 Hz (1 flash per second)
Audible Sounders	12-48 Vac/dc: < 20 mA	12-48 Vac/dc: < 20 mA
	120-230 Vac: < 50 mA 90 decibels at 1 meter	120-230 Vac: < 50 mA 90 decibels at 1 meter
Connection Type	Screw Clamp	Screw Clamp
Cable Size	1 x 16 AWG (1.5 mm ²) With Cable End	1 x 16 AWG (1.5 mm ²) With Cable End
Digest Location	XVB 70 mm Beacons, page 19-115	XVB 70 mm Components, page 19-116

Tower Lights and Beacons Selection Guide (2 of 2)



Family	XVC 4	XVC 6	XVC 1	XVU	XVGU	XVR	XVS
Type of Product	*Tower Light	*Tower Light	*Tower Light	**Tower Light	**Tower Light	***Rotating Mirror Beacon	***Siren and Electronic Alarm
Diameter	40 mm	60 mm	100 mm	60mm	60mm	84/106/120/130 mm	—
Features	All devices are pre-assembled and pre-wired			Programmable LED module with multiple colors, flashing, blinking, and rotating	Programmable with Magelis through USB	All devices are pre-assembled and pre-wired. XVR12***S includes buzzer: 70 to 90 decibels	Adjustable Tones XVS14BMW, 0 to 105 decibels, 43 tones XVS72BM**, 0 to 90 decibels, 16 tones
Approvals	UL Recognized E164353 CNN NKCR	UL Recognized E164353 CNN NKCR	UL Recognized E164353 CNN NKCR	UL file: E164353 CCN : NKCR	UL File E164353 CCN NKCR	UL Recognized E164353 CNN NKCR	UL Recognized E164353 GNN UCST
Conforming to Standards	CSA LR44087 Class 3211-03	CSA LR44087 Class 3211-03	CSA LR44087 Class 3211-03	CSA File : 225619 CLASS : 3211-07	cUL File: E164353 CCN: NKCR7	CSA LR44087 Class 3211-03	CSA LR44087 Class 3211-03
	CE Marked	CE Marked	CE Marked	CE Marked	CE Marked	CE Marked	CE Marked
	EN61000-6-2	EN61000-6-2	EN61000-6-2	EN 60947-1	EN 61000-6-2	EN61000-6-2	—
	EN61000-6-3	EN61000-6-3	EN61000-6-3	EN 60947-5-1	—	EN61000-6-4	—
	—	EN61000-6-4	EN61000-6-4	—	EN 61000-6-2	—	—
UL 508	UL 508	UL 508	UL508	UL508	UL 508	UL 508	
CSA 22.2 No. 14	CSA 22.2 No. 14	CSA 22.2 No. 14	CSA C22.2 No.14	CSA C22.2 No.14	CSA 22.2 No. 14	CSA 22.2 No. 14	
Degree of Protection	IP54	IP54	IP54	IP65	IP42	IP23 / IP65 / IP66	IP53 / IP54
Operating Temperature F° (C°)	-13 to 122 (-25 to 50)	-13 to 122 (-25 to 50)	-13 to 122 (-25 to 50)	-13 to 122 (-25 to 50)	32 to 131 (0 to 55)	-14 to 122 (-10 to 50)	-4 to 122 (-20 to 50)
Storage Temperature F° (C°)	-40 to 158 (-40 to 70)	-40 to 158 (-40 to 70)	-40 to 158 (-40 to 70)	-13 to 150 (-25 to 65)	-31 to 158 (-35 to 70)	-31 to 158 (-35 to 70)	-31 to 158 (-35 to 70)
Light Source	LED	LED	LED	LED	LED	LED	—
Electrical Consumption				Body unit ≤ 400mA	400mA		
LED Steady	24 V: 1 unit = 40mA; 2 unit = 80mA; 3 unit = 120mA; 4 unit = 160mA; 5 unit = 200mA	24 V: 1 unit = 100mA; 2 unit = 200mA; 3 unit = 300mA; 4 unit = 400mA; 5 unit = 500mA	24 V: 1 unit = 100mA; 2 unit = 200mA; 3 unit = 300mA; 4 unit = 400mA; 5 unit = 500mA	LED Units ≤ 50 mA	Programmable with Magelis through USB	XVR08, XVR10, XVR12, and XVR13 (without buzzer) 12 Vac/dc: 360mA 24 Vac/dc: 180mA	—
LED Flashing ** with Buzzer	**24 V: 1 unit = 90 mA; 2 unit = 130 mA; 3 unit = 170 mA; 4 unit = 210 mA; 5 unit = 250 mA 0.7 to 3 Hz (1 flash per 0.7 to 3 sec)	24 V: 1 unit = 150mA; 2 unit = 250mA; 3 unit = 350mA; 4 unit = 450mA; 5 unit = 550mA 3 to 3.5 Hz (1 flash per 3 to 3.5 sec)	24 V: 1 unit = 150mA; 2 unit = 250mA; 3 unit = 350mA; 4 unit = 450mA; 5 unit = 550mA 3 to 3.5 Hz (1 flash per 3 to 3.5 sec)	Buzzer ≤ 70 mA Flasher and multi-color ≤ 70 mA	Programmable with Magelis through USB	XVR12 with buzzer: 12 Vac/dc: 400 mA 24 Vac/dc: 230 mA 3 Hz (1 flash per 3 sec)	—
Strobe (Energized)	—	—	—	—	—	—	—
Audible Sounders	70 to 85 decibels at 1 meter	70 to 85 decibels at 1 meter	60 to 85 decibels at 1 meter	—	—	—	XVS14BMW 12 Vdc: 350mA 24 Vdc: 400 mA 105 decibels at 1 m XVS72BM 12 Vdc: 280 mA 24 Vdc: 190 mA 90 decibels at 1 m
Connection Type	Pre-Wired, Color-Coded Wires cable length: 600mm XVC4** 900mm XVC4**K 500mm XVC4**5S	Pre-Wired, Color-Coded Wires cable length: 600mm XVC6** 850mm XVC6**K 550mm XVC6**5S 850mm XVC6**5SK	Pre-Wired, Color-Coded Wires cable length: 500mm XVC1**K 500mm XVC1**SK 550mm XVC6**5S 850mm XVC6**5SK	Screw Clamp	USB power cable: - 300 mm/ 11.81 in. for tube mounting - 400 mm/ 15.75 in. for direct mounting	Pre-Wired cable length: 500mm XVR08** 400mm XVR10** 400mm XVR12** 400mm XVR13**	XVS14BMW Pre-Wired, Color-Coded Wires cable length: 500mm XVS14 XVS72BM** Not Pre-Wired
Cable Size	22 AWG (0.33 mm ²)	22 AWG (0.33 mm ²)	22 AWG (0.33 mm ²)	22 - 16 AWG	—	18 AWG (0.75 mm ²)	—
Digest Location	XVC, page 19-118	XVC, page 19-118	XVC, page 19-118	XVU, page 19-120	XVGU, page 19-122	XVR, page 19-123	XVS, page 19-124

For Tower Lights catalog numbers:
● first dot denotes voltage selection
● second dot denotes color selection

Pendant Station Selection Guide

Family	XAR eXL Hoist	9001BW	XACA2	XACA0	9001SKYP
--------	---------------	--------	-------	-------	----------



Type of Product	*Wireless Pendant	**2-Button Pendant	**2-Button Pistol Grip Pendant	**General Purpose Pendant	**Heavy Duty Pendant
Number of operators	6	2	2	2, 3, 4, 6, 8, 12	2, 4, 6, 8, 10
Approvals	UL File E164353, CCN NKCR/NKR7 (cULus) CSA File LR44087 Class 3211-07	UL File E78403 CNN NKCR CSA File LR25490 Class 3211-03	UL File E164353 CNN NKCR CSA File LR 44087 Class 3211-03	UL File E164353 CNN NKCR CSA File LR 44087 Class 3211-03	UL File E78403 CNN NKCR CSA File LR25490 Class 3211-03
Conforming to Standards	EN/IEC 60947-5-1, EN/IEC 60204-32, UL 508, CSA 22-2 No. 14 and EN/ISO 13849-1, EN/IEC 62061, EN/IEC 61508, EN/ISO 13850 EN 13557, EN 15011 UL, CSA, CE, CCC RoHS Compliant	CE Marked	EN/IEC 60947-5-1, EN/IEC 60204-32, EN/IEC 60947-5-5, and EN/ISO 13850 (for versions with trigger action emergency stop) UL 508 CSA C22-2 No. 14 RoHS compliant	EN/IEC 60947-5-1, EN/IEC 60204-32, EN/IEC 60947-5-5, and EN/ISO 13850 (for versions with trigger action emergency stop) UL 508 CSA C22-2 No. 14 RoHS compliant	CE Marked
Degree of Protection	IP65, NEMA 4	NEMA 1, 3, 3R, 4, 4X	NEMA 1, 4, 4X, 5 IP65 IK08	NEMA 1, 4, 4X, 5 IP65 IK08	NEMA 1, 2, 3, 4, 4X, 12, 13
Operating Temperature F° (C°)	-4 to 140 (-20 to 60)	-13 to 140 (-25 to 60)	-13 to 140 (-25 to 60)	-13 to 140 (-25 to 60)	-13 to 140 (-25 to 60)
Storage Temperature F° (C°)	-4 to 140 (-20 to 60)	-40 to 158 (-40 to 70)	-40 to 158 (-40 to 70)	-40 to 158 (-40 to 70)	-40 to 158 (-40 to 70)
Housing Material	Polycarbonate (PBT)	Polycarbonate / PET Polyester Blend	Yellow Polypropylene	Yellow Polypropylene	Yellow Polycarbonate
Rated Operational Characteristics [1]	ZBRH●H AC - C300 ZBRH●W AC - B300 DC - R300	AC - B600 DC - P600	AC-15: A600 or Ue = 600V, Ie = 1.2A or Ue = 240V, Ie = 3A DC-13: Q600 or Ue = 600V, Ie = 0.1A or Ue = 250V, Ie = 0.27A	AC-15: A600 or Ue = 600V, Ie = 1.2A or Ue = 240V, Ie = 3A DC-13: Q600 or Ue = 600V, Ie = 0.1A or Ue = 250V, Ie = 0.27A	SKRU2-SKRU5 AC - B300 DC - P600 SKRU1, 10, 11 AC - A600 DC - P600
Thermal Current	ZBRH●H - 4A ZBRH●W - 6A	Continuous 5A	Continuous 10A	Continuous 10A	—
Connection Type	—	1/2 in. NPT screw clamp terminals	8–26 mm cable entry screw clamp terminals	8–26 mm cable entry screw clamp terminals	NPT threaded conduit entry screw clamp terminals
Cable Size	None: Wireless	—	1 x 0.5 mm ² (20AWG) min. 2 x 1.5 mm ² (16AWG) max. 1 x 2.5 mm ² (14AWG) max.	1 x 14 AWG (copper only)	—
Digest Location	XAR, page 19-125	Type BW, page 19-127	XAC, page 19-128	XAC, page 19-128	SKYP, page 19-131

[1] OSHA Section 1910.179, *Overhead and Gantry Cranes*, limits voltage at pendant push buttons to 150 Vac or 300 Vdc max.

XB4–XB5 Common Operators

Table 19.1: BLACK—Start Push Buttons (flush head)





Operator Style	Description	Contact Block	Type	Legend Plate
XB4 Die Cast Chrome		 1 N.O.	XB4BA21	ZBY2303
XB5 Double Insulated		 1 N.O.	XB5AA21	ZBY2303

Table 19.2: RED—Stop Push Buttons (extended head)





Operator Style	Description	Contact Block	Type	Legend Plate
XB4 Die Cast Chrome		 1 N.C.	XB4BL42	ZBY2304
XB5 Double Insulated		 1 N.C.	XB5AL42	ZBY2304

Table 19.3: BLACK—Off-On Selector Switch





Operator Style	Description	Contact Block	Type	Legend Plate
XB4 Die Cast Chrome		 1 N.O.	XB4BD21	ZBY2367
XB5 Double Insulated		 1 N.O.	XB5AD21	ZBY2367

Table 19.4: Hand-Off-Auto Selector Switch





Operator Style	Description	Contact Block	Type	Legend Plate
XB4 Die Cast Chrome		 2 N.O.	XB4BD33	ZBY2387
XB5 Double Insulated		 2 N.O.	XB5AD33	ZBY2387

Table 19.5: RED—120 Vac LED—On Pilot Light



Operator Style	Description	Contact Block	Type	Legend Plate
XB4 Die Cast Chrome		120 Vac Red LED	XB4BVG4	ZBY2311
XB5 Double Insulated		120 Vac Red LED	XB5AVG4	ZBY2311

Table 19.6: GREEN—120 Vac LED—Off Pilot Light



Operator Style	Description	Contact Block	Type	Legend Plate
XB4 Die Cast Chrome		120 Vac Green LED	XB4BVG3	ZBY2312
XB5 Double Insulated		120 Vac Green LED	XB5AVG3	ZBY2312

Table 19.7: RED—40 mm Mushroom Stop (Push-Pull)









Operator Style	Description	Contact Block	Type	Legend Plate
XB4 Die Cast Chrome		 1 N.C.	XB4BT42	ZBY9330
XB5 Double Insulated		 1 N.C.	XB5AT42	ZBY9330

Table 19.8: RED—40 mm Mushroom Emergency Stop (Trigger Action, Turn-to-Release)

Operator Style	Description	Contact Block	Type	Legend Plate 60 mm Round
XB4 Die Cast Chrome		 1 N.O. / 1 N.C.	XB4BS8445	ZBY9330
XB5 Double Insulated		 1 N.O. / 1 N.C.	XB5AS8445	ZBY9330

When ordering, please specify:

Quantity
Type or Catalog Number

Type K and SK Common Operators

Table 19.9: BLACK—Start Push Buttons





Operator Style	Description	Contact Block	Type [1]	Legend Plate [1]
30 mm Industrial (Metal)			KR1BH13	KN201
30 mm Corrosion Resistant (Non-Metallic)			SKR1BH13	KN101SP

Table 19.10: RED—Stop Push Buttons





Operator Style	Description	Contact Block	Type [1]	Legend Plate [1]
30 mm Industrial (Metal)			KR1RH13	KN202
30 mm Corrosion Resistant (Non-Metallic)			SKR1RH13	KN102RP

Table 19.11: BLACK—Off-On Selector Switch



Operator Style	Description	Contact Sequence (Contact Block Included)	Type [1]	Legend Plate [1]
30 mm Industrial (Metal)			KS11BH13	KN244
30 mm Corrosion Resistant (Non-Metallic)			SKS11BH13	KN144SP

Table 19.12: BLACK—Hand-Off-Auto Selector Switch



Operator Style	Description	Contact Sequence (Contact Block Included)	Type [1]	Legend Plate [1]
30 mm Industrial (Metal)			KS43BH13	KN260
30 mm Corrosion Resistant (Non-Metallic)			SKS43BH13	KN160SP

Table 19.13: RED—120 Vac—On Pilot Light



Operator Style	Description	Type [1]	Legend Plate [1]
30 mm Industrial (Metal)		KP1R31	KN203
30 mm Corrosion Resistant (Non-Metallic)		SKP1R31	KN103SP

Table 19.14: GREEN—120 Vac—Off Pilot Light

Operator Style	Description	Type [1]	Legend Plate [1]
30 mm Industrial (Metal)		KP1G31	KN204
30 mm Corrosion Resistant (Non-Metallic)		SKP1G31	KN104SP

Table 19.15: RED—120 Vac—On Push-To-Test Pilot Light





Operator Style	Description	Type [1]	Legend Plate [1]
30 mm Industrial (Metal)		KT1R31	KN203
30 mm Corrosion Resistant (Non-Metallic)		SKT1R31	KN103SP

Table 19.16: GREEN—120 Vac—Off Push-To-Test Pilot Light

Operator Style	Description	Type [1]	Legend Plate [1]
30 mm Industrial (Metal)		KT1G31	KN204
30 mm Corrosion Resistant (Non-Metallic)		SKT1G31	KN104RP

When ordering, please specify:

Quantity
Class Number (if appropriate)
Type or Catalog Number

[1] When ordering, add prefix 9001 to the catalog number.

XVL Miniature LED

Table 19.17: Specifications

Conforming to standards	IEC 337-2, NF C 63-140, VDE 0660-200
Degree of protection	IP40 (IP65 with seal) conforming to IEC 529 and NF C 20-010
Current consumption	25 mA
Cabling	XVLA1●●, XVLA2●●: tags for 2.8 x 0.5 mm Faston connectors, also for soldered connections. XVLA3●●: threaded connectors, clamping, capacity: min. 1 x 0.2 mm ² , max. 1 x 1.5 mm ²



XVLA1●●



XVLA2●●



XVLA3●●

Table 19.18: With Black Bezel, Raised LED

Description	Supply Voltage DC	Color	Catalog Number
Ø 8 mm [1] with integral ballast resistor and reverse polarity protection diode Degree of protection IP40 LED pilot lights Ø 8 mm, with black bezel, visible LED XVLA1●●	12 V	Green	XVLA123
		Red	XVLA124
		Amber	XVLA125
	24 V	Green	XVLA133
		Red	XVLA134
		Amber	XVLA135

Table 19.19: With Integral Lens Cap, Covered LED

Description	Supply Voltage DC	Color	Catalog Number
Ø 8 mm [1] with integral ballast resistor and reverse polarity protection diode Degree of protection IP40 Ø 8 mm, with lens incorporated, LED XVLA2	12 V	Green	XVLA223
		Red	XVLA224
		Amber	XVLA225
	24 V	Green	XVLA233
		Red	XVLA234
		Amber	XVLA235
Ø 12 mm [2] with integral ballast resistor and reverse polarity protection diode Degree of protection IP40 Ø 12 mm, with lens incorporated, LED XVLA3	12 V	Green	XVLA323
		Red	XVLA324
		Amber	XVLA325
	24 V	Green	XVLA333
		Red	XVLA334
		Amber	XVLA335

Table 19.20: Accessories

Description	Catalog Number	
Tightening tools (Sold singly)	For Ø 8 mm pilot lights	XVLX08
	For Ø 12 mm pilot lights	XVLX12
Seals (IP65) (Sold in lots of 10)	For Ø 8 mm pilot lights	XVLZ911
	For Ø 12 mm pilot lights	XVLZ912

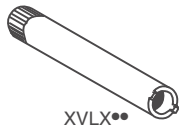

XVLX●●



XVLZ91●

[1] Quick connects (2.8 x 0.5 mm).

[2] Screw termination.



Type JP1R29

Standard, Push-To-Test, and Remote Test Pilot Lights

Class 9001 Type J compact pilot lights are designed to be mounted in a 0.69 in. (11/16 in. or 17.5 mm) diameter mounting hole. Each terminal accepts up to two 14 AWG wires (CU only). Type J compact pilot lights meet NEMA 4 (watertight) and NEMA 13 (oiltight). Type JT push-to-test pilot lights have contacts built into the encapsulated body. Type JTR remote test pilot lights have dual inputs for one push remote testing—all you need is a push button with a current rating equal to or greater than the total lamp draw. Type JTR remote test pilot lights can also be energized from two separate input signals of the same voltage and polarity. This is done by wiring the Test terminal to the second input signal.

Table 19.21: Standard Pilot Light [3]

Style/Voltage	Color Cap ^[4]				Lamp	Replacement Lamp
	None	Red	Green	Yellow		
Transformer, 110–120 V, 50–60 Hz	JP1	JP1R29	JP1G29	JP1Y29	6.3 V, 0.15 A	2550101020
Incandescent, 120 Vac/Vdc	JP38	JP38R29	JP38G29	JP38Y29	120 V, 0.015 A	2550101040
Incandescent, 24–28 Vac/Vdc	JP35	JP35R29	JP35G29	JP35Y29	28 V, 0.040 A	2550101024
LED, 24–28 Vac	—	JP35LRR29	JP35LGG29	JP35LYY29	28 V, 0.03 A	—
LED, 24–28 Vdc	—	JP35DRR29	JP35DGG29	JP35DYY29	28 V, 0.03 A	—
LED, 120 Vac	—	JP38LRR29	JP38LGG29	JP38LYY29	28 V, 0.03 A	—
Replacement LED, 120 Vac	Red	—	—	—	—	6508805207
	Yellow	—	—	—	—	6508805208
	Green	—	—	—	—	6508805209



Table 19.22: Push-To-Test Pilot Light [3]

Style/Voltage	Color Cap ^[4]				Lamp	Replacement Lamp
	None	Red	Green	Yellow		
Transformer, 110–120 V, 50–60 Hz	JT1	JT1R29	JT1G29	JT1Y29	6.3 V, 0.15 A	2550101020
Incandescent, 120 Vac/Vdc	JT38	JT38R29	JT38G29	JT38Y29	120 V, 0.015 A	2550101040
Incandescent, 24–28 Vac/Vdc	JT35	JT35R29	JT35G29	JT35Y29	28 V, 0.040 A	2550101024
LED, 24–28 Vac	—	JT35LRR29	JT35LGG29	JT35LYY29	28 V, 0.03 A	—
LED, 24–28 Vdc	—	JT35DRR29	JT35DGG29	JT35DYY29	28 V, 0.03 A	—
LED, 120 Vac	—	JT38LRR29	JT38LGG29	JT38LYY29	28 V, 0.03 A	—
Replacement LED, 120 Vac	Red	—	—	—	—	6508805207
	Yellow	—	—	—	—	6508805208
	Green	—	—	—	—	6508805209

Table 19.23: Color Caps, Class 9001 Type J

Color	Replacement Color Caps
	Plastic ^[4]
Red	R29
Green	G29
Amber	A29
Blue	L29
White	W29
Yellow	Y29

Table 19.24: Legend Plates

Description	Maximum Number of Lines	Maximum Number of Characters	Catalog Number ^[4]	
 Blank Special Marking (Specify Marking)	Black Field Red Field	2	8	JN100 JN100R
	Black Field Red Field			JN199 JN199R
 Blank Special Marking (Specify Marking)	Aluminum Field	2	16	JN700
	Aluminum Field			JN799

[3] Other voltages are available. Refer to Catalog 9001CT0001.

[4] When ordering, add prefix 9001 to the catalog number.

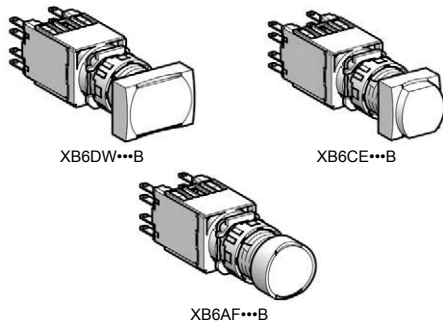

XB6 Complete Devices

Table 19.25: Illuminated Push Buttons (12–24 Vac/Vdc LED included)
Complete Units with Quick Connectors/Solder Tabs

Type of Operator	Type of Contact		Color	Rectangular	Square	Round
	N.O.	N.C.		Catalog Number		
Flush, spring return	1	—	White	XB6DW1B1B	XB6CW1B1B	XB6AW1B1B
			Green	XB6DW3B1B	XB6CW3B1B	XB6AW3B1B
			Yellow	XB6DW5B1B	XB6CW5B1B	XB6AW5B1B
			Blue	XB6DW6B1B	XB6CW6B1B	XB6AW6B1B
	—	1	Red	XB6DW4B2B	XB6CW4B2B	XB6AW4B2B
			White	XB6DW1B5B	XB6CW1B5B	XB6AW1B5B
			Green	XB6DW3B5B	XB6CW3B5B	XB6AW3B5B
			Red	XB6DW4B5B	XB6CW4B5B	XB6AW4B5B
	1	1	Yellow	XB6DW5B5B	XB6CW5B5B	XB6AW5B5B
			Blue	XB6DW6B5B	XB6CW6B5B	XB6AW6B5B
			White	XB6DF1B1B	XB6CF1B1B	XB6AF1B1B
			Green	XB6DF3B1B	XB6CF3B1B	XB6AF3B1B
Flush, maintained	1	—	Yellow	XB6DF5B1B	XB6CF5B1B	XB6AF5B1B
			Blue	XB6DF6B1B	XB6CF6B1B	XB6AF6B1B
			Red	XB6DF4B2B	XB6CF4B2B	XB6AF4B2B
			White	XB6DF1B5B	XB6CF1B5B	XB6AF1B5B
	—	1	Green	XB6DF3B5B	XB6CF3B5B	XB6AF3B5B
			Red	XB6DF4B5B	XB6CF4B5B	XB6AF4B5B
			Yellow	XB6DF5B5B	XB6CF5B5B	XB6AF5B5B
			Blue	XB6DF6B5B	XB6CF6B5B	XB6AF6B5B
	1	1	White	XB6DE1B1B	XB6CE1B1B	XB6AE1B1B
			Green	XB6DE3B1B	XB6CE3B1B	XB6AE3B1B
			Yellow	XB6DE5B1B	XB6CE5B1B	XB6AE5B1B
			Blue	XB6DE6B1B	XB6CE6B1B	XB6AE6B1B
—	1	Red	XB6DE4B2B	XB6CE4B2B	XB6AE4B2B	
		White	XB6DE1B5B	XB6CE1B5B	XB6AE1B5B	
		Green	XB6DE3B5B	XB6CE3B5B	XB6AE3B5B	
		Red	XB6DE4B5B	XB6CE4B5B	XB6AE4B5B	
1	1	Yellow	XB6DE5B5B	XB6CE5B5B	XB6AE5B5B	
		Blue	XB6DE6B5B	XB6CE6B5B	XB6AE6B5B	

Table 19.26: Illuminated Push Buttons (120 Vac LED included)
Complete Units with Quick Connectors/Solder Tabs

Type of Operator	Type of Contact		Color	Rectangular	Square	Round
	N.O.	N.C.		Catalog Number		
Flush, spring return	1	—	White	XB6DW1G1B	XB6CW1G1B	XB6AW1G1B
			Green	XB6DW3G1B	XB6CW3G1B	XB6AW3G1B
			Yellow	XB6DW5G1B	XB6CW5G1B	XB6AW5G1B
			Blue	XB6DW6G1B	XB6CW6G1B	XB6AW6G1B
	—	1	Red	XB6DW4G2B	XB6CW4G2B	XB6AW4G2B
			White	XB6DW1G5B	XB6CW1G5B	XB6AW1G5B
			Green	XB6DW3G5B	XB6CW3G5B	XB6AW3G5B
			Red	XB6DW4G5B	XB6CW4G5B	XB6AW4G5B
	1	1	Yellow	XB6DW5G5B	XB6CW5G5B	XB6AW5G5B
			Blue	XB6DW6G5B	XB6CW6G5B	XB6AW6G5B
			White	XB6DF1G1B	XB6CF1G1B	XB6AF1G1B
			Green	XB6DF3G1B	XB6CF3G1B	XB6AF3G1B
Flush, maintained	1	—	Yellow	XB6DF5G1B	XB6CF5G1B	XB6AF5G1B
			Blue	XB6DF6G1B	XB6CF6G1B	XB6AF6G1B
			Red	XB6DF4G2B	XB6CF4G2B	XB6AF4G2B
			White	XB6DF1G5B	XB6CF1G5B	XB6AF1G5B
	—	1	Green	XB6DF3G5B	XB6CF3G5B	XB6AF3G5B
			Red	XB6DF4G5B	XB6CF4G5B	XB6AF4G5B
			Yellow	XB6DF5G5B	XB6CF5G5B	XB6AF5G5B
			Blue	XB6DF6G5B	XB6CF6G5B	XB6AF6G5B
	1	1	White	XB6DE1G1B	XB6CE1G1B	XB6AE1G1B
			Green	XB6DE3G1B	XB6CE3G1B	XB6AE3G1B
			Yellow	XB6DE5G1B	XB6CE5G1B	XB6AE5G1B
			Blue	XB6DE6G1B	XB6CE6G1B	XB6AE6G1B
—	1	Red	XB6DE4G2B	XB6CE4G2B	XB6AE4G2B	
		White	XB6DE1G5B	XB6CE1G5B	XB6AE1G5B	
		Green	XB6DE3G5B	XB6CE3G5B	XB6AE3G5B	
		Red	XB6DE4G5B	XB6CE4G5B	XB6AE4G5B	
1	1	Yellow	XB6DE5G5B	XB6CE5G5B	XB6AE5G5B	
		Blue	XB6DE6G5B	XB6CE6G5B	XB6AE6G5B	

For Legends, see [XB6 Legend Plates and Legends](#), page 19-20

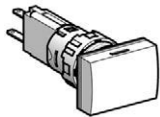

XB6DV**B

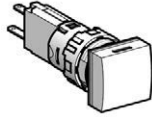

XB6CV**B

**Table 19.27: Pilot Lights (12–24 Vac/Vdc LED included)
Complete Units with Quick Connectors/Solder Tabs**

Color	Rectangular	Square	Round
	Catalog Number		
White	XB6DV1BB	XB6CV1BB	XB6AV1BB
Green	XB6DV3BB	XB6CV3BB	XB6AV3BB
Red	XB6DV4BB	XB6CV4BB	XB6AV4BB
Yellow	XB6DV5BB	XB6CV5BB	XB6AV5BB
Blue	XB6DV6BB	XB6CV6BB	XB6AV6BB

**Table 19.28: Pilot Lights (120 Vac LED)
Complete Units with Quick Connectors/Solder Tabs**

Color	Rectangular	Square	Round
	Catalog Number		
White	XB6DV1GB	XB6CV1GB	XB6AV1GB
Green	XB6DV3GB	XB6CV3GB	XB6AV3GB
Red	XB6DV4GB	XB6CV4GB	XB6AV4GB
Yellow	XB6DV5GB	XB6CV5GB	XB6AV5GB
Blue	XB6DV6GB	XB6CV6GB	XB6AV6GB

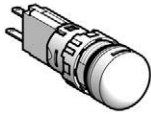

XB6AV**B

**Table 19.29: Push Buttons (Non-Illuminated)
Complete Units with Quick Connectors/Solder Tabs**

Type of Push	Type of Contact		Color	Rectangular	Square	Round
	N.O.	N.C.		Catalog Number		
Flush, spring return	1	—	White	XB6DA11B	XB6CA11B	XB6AA11B
			Black	XB6DA21B	XB6CA21B	XB6AA21B
			Green	XB6DA31B	XB6CA31B	XB6AA31B
			Yellow	XB6DA51B	XB6CA51B	XB6AA51B
			Blue	XB6DA61B	XB6CA61B	XB6AA61B
			Black	XB6DA22B	XB6CA22B	XB6AA22B
	—	1	Red	XB6DA42B	XB6CA42B	XB6AA42B
			White	XB6DA15B	XB6CA15B	XB6AA15B
			Black	XB6DA25B	XB6CA25B	XB6AA25B
			Green	XB6DA35B	XB6CA35B	XB6AA35B
			Red	XB6DA45B	XB6CA45B	XB6AA45B
			Yellow	XB6DA55B	XB6CA55B	XB6AA55B
1	1	Blue	XB6DA65B	XB6CA65B	XB6AA65B	

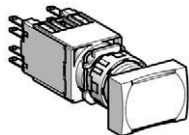

XB6DA**B

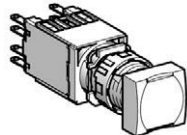

XB6CA**B

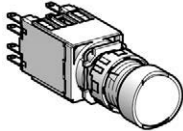

XB6AA**B

Table 19.30: Trigger Action Emergency Stop Mushroom Head Push Buttons (Color Red) [1]

Shape of Head	Type of Push	Type of Contact		Diameter of Head (mm)	Catalog Number
		N.O.	N.C.		
Turn-to-release	—	—	1	30	XB6AS8342B
		1	1	30	XB6AS8345B
Key release	—	—	1	30	XB6AS9342B [2]
		1	1	30	XB6AS9345B [2]

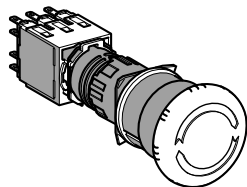

XB6AS8345B

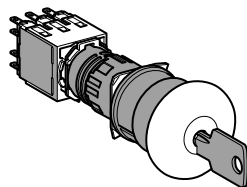

XB6AS9345B



ZB6Y7330

Table 19.31: Circular Legends, 45 mm

Description	Color	Text	Catalog Number
Circular legends, 45 mm	Yellow	Blank	ZB6Y7001
		Emergency stop	ZB6Y7330

For Legends, see XB6 Legend Plates and Legends, page 19-20

[1] Complies with ISO 13850 standards for Emergency Stop push buttons when used with circular Legend Plate ZB6Y7330 (see Table 19.31 Circular Legends, 45 mm, page 19-13)
[2] Ronis 200 key

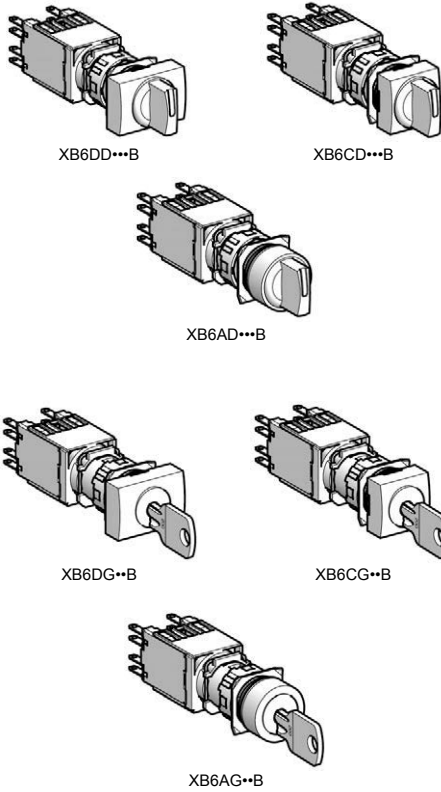

Table 19.32: Selector Switches (Switching Angle: Handle: 60°) Complete Units with Quick Connectors/Solder Tabs

Type of Operator	Type of Contact		Number and Type of Positions	Rectangular	Square	Round	
	N.O.	N.C.		Catalog Number			
Handle	1	—	2-maintained		XB6DD221B	XB6CD221B	XB6AD221B
	1	1	2-maintained		XB6DD225B	XB6CD225B	XB6AD225B
			3-maintained		XB6DD235B	XB6CD235B	XB6AD235B
	2	—	3-maintained		XB6DD233B	XB6CD233B	XB6AD233B

Table 19.33: Selector Switches (Switching Angle: Key: 70°) Complete Units with Quick Connectors/Solder Tabs

Type of Operator	Type of Contact		Number and Type of Positions	Rectangular	Square	Round	
	N.O.	N.C.		Catalog Number			
Key	1	1	2-maintained		XB6DGC5B	XB6CGC5B	XB6AGC5B
			2-maintained		XB6DGB5B	XB6CGB5B	XB6AGB5B
			3-maintained		XB6DGH5B	XB6CGH5B	XB6AGH5B
	2	—	3-maintained		XB6DGH3B	XB6CGH3B	XB6AGH3B

NOTE: The symbol indicates key withdrawal position(s).

Table 19.34: Selector Switch Sequence

2 Position Selector Switch			Contact block guide [3]
			1 N.O. (left or right)
			1 N.C. (left or right)
			1 N.O. and 1 N.C.

3 Position Selector Switch			Contact block guide [3]
			1 N.O. (left)
			2 N.O. wired in parallel (side by side)
			1 N.O. (right)
			1 N.C. (right)
			1 N.C. (left)
			2 N.C. wired in series (side by side)

For Legends, see [Legend Plates and Legends](#), page 19-20

[3] As viewed from the front of the panel.

XB6 Electrical Components

Table 19.35: Contact Blocks and Light Modules for Illuminated Push Buttons [4]

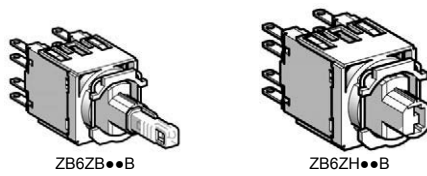

Description	Supply Voltage	Type of Contact		Color of Light Source	Catalog Number	
		N.O.	N.C.			
Quick connectors/solder tabs						
Integral LED [5]	12–24 Vac/Vdc	1	—	White	ZB6ZB11B	
				Green	ZB6ZB31B	
				Yellow	ZB6ZB51B	
				Blue	ZB6ZB61B	
				Red	ZB6ZB42B	
		—	1	1	Yellow	ZB6ZB52B
					White	ZB6ZB15B
					Green	ZB6ZB35B
					Red	ZB6ZB45B
					Yellow	ZB6ZB55B
	120 Vac	1	—	Blue	ZB6ZB65B	
				White	ZB6ZG11B	
				Green	ZB6ZG31B	
				Yellow	ZB6ZG51B	
				Blue	ZB6ZG61B	
		—	1	1	Red	ZB6ZG42B
					Yellow	ZB6ZG52B
					White	ZB6ZG15B
					Green	ZB6ZG35B
					Red	ZB6ZG45B
Direct for incandescent bulb (not included) [6]	< 24 Vac/Vdc	1	—	Yellow	ZB6ZG55B	
				Blue	ZB6ZG65B	
				—	ZB6ZH01B	
—	—	1	—	—	ZB6ZH02B	
1	—	1	—	—	ZB6ZH05B	

Table 19.36: Contact Blocks for Push Buttons and Selector Switches

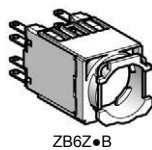

Description	Type of Contact		Catalog Number
	N.O.	N.C.	
Quick connectors/solder tabs			
Contact blocks with mounting base	1	—	ZB6Z1B
	—	1	ZB6Z2B
	2	—	ZB6Z3B
	—	2	ZB6Z4B
	1	1	ZB6Z5B

Table 19.37: Light Modules for Pilot Lights

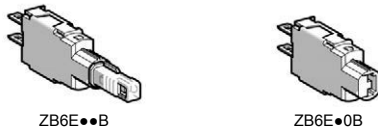

Description	Supply Voltage	Color of Light Source	Catalog Number
Quick connectors/solder tabs [7]			
Integral LED [8]	12–24 Vac/Vdc	White	ZB6EB1B
		Green	ZB6EB3B
		Red	ZB6EB4B
		Yellow	ZB6EB5B
		Blue	ZB6EB6B
	120 Vac	White	ZB6EG1B
		Green	ZB6EG3B
		Red	ZB6EG4B
		Yellow	ZB6EG5B
		Blue	ZB6EG6B
With resistor for 95 V neon bulb (not included) [6] [9]	110 Vac	—	ZB6EG0B
—	230 Vac	—	ZB6EM0B
Direct supply for 0.6 W max. incandescent bulb (not included) [6]	< 24 Vac/Vdc	—	ZB6EH0B

Table 19.38: Separate Contact Blocks (Maximum of 3 contacts per mounting base.)

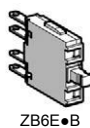

Contact Material	For use with mounting base	Type of Contact		Catalog Number
		N.O.	N.C.	
Silver alloy	Quick connectors/solder tabs	1	—	ZB6E1B
		—	1	ZB6E2B
		1	—	ZB6E1E
Gold flashed	Quick connectors/solder tabs	—	1	ZB6E2E

Table 19.39: Accessories for Printed Circuit Board Installations

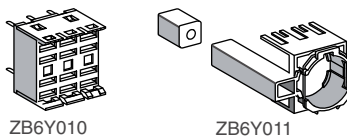

Description	for use with	Catalog Number
Plug-in Socket Adapter	contact blocks and light modules	ZB6Y010
Body Bracket	plug-in socket adapter	ZB6Y011

[4] Illuminated selector switches can be assembled by using a contact block/light module assembly in conjunction with a selector switch head, supplied without handle, and a transparent handle. See *XB6 Illuminated Operators*, page 19-16.
 [5] The LED must be the same color as the push button cap.
 [6] Order bulbs separately. See *Additional XB6 Accessories*, page 19-20.
 [7] Electrical components with connection by printed circuit board pins are available. See *Additional XB6 Accessories*, page 19-20.
 [8] The LED must be the same color as the lens.
 [9] Neon bulb can only be used with a red, yellow, or white cap.

XB6 Illuminated Operators

Table 19.40: Heads for Illuminated Push Buttons^[10]

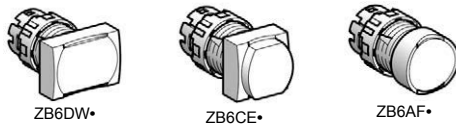

Type of Push	Color	Rectangular	Square	Round
		Catalog Number		
Flush, spring return	White	ZB6DW1	ZB6CW1	ZB6AW1
	Green	ZB6DW3	ZB6CW3	ZB6AW3
	Red	ZB6DW4	ZB6CW4	ZB6AW4
	Yellow	ZB6DW5	ZB6CW5	ZB6AW5
	Blue	ZB6DW6	ZB6CW6	ZB6AW6
	5 colors ^[11]	ZB6DW9	ZB6CW9	ZB6AW9
Flush, maintained	White	ZB6DF1	ZB6CF1	ZB6AF1
	Green	ZB6DF3	ZB6CF3	ZB6AF3
	Red	ZB6DF4	ZB6CF4	ZB6AF4
	Yellow	ZB6DF5	ZB6CF5	ZB6AF5
	Blue	ZB6DF6	ZB6CF6	ZB6AF6
	5 colors ^[11]	ZB6DF9	ZB6CF9	ZB6AF9
Extended, spring return	White	ZB6DE1	ZB6CE1	ZB6AE1
	Green	ZB6DE3	ZB6CE3	ZB6AE3
	Red	ZB6DE4	ZB6CE4	ZB6AE4
	Yellow	ZB6DE5	ZB6CE5	ZB6AE5
	Blue	ZB6DE6	ZB6CE6	ZB6AE6
	5 colors ^[11]	ZB6DE9	ZB6CE9	ZB6AE9

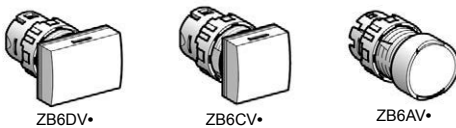

Table 19.41: Heads for Pilot Lights^[10]

Color	Rectangular	Square	Round
	Catalog Number		
White	ZB6DV1	ZB6CV1	ZB6AV1
Green	ZB6DV3	ZB6CV3	ZB6AV3
Red	ZB6DV4	ZB6CV4	ZB6AV4
Yellow	ZB6DV5	ZB6CV5	ZB6AV5
Blue	ZB6DV6	ZB6CV6	ZB6AV6
5 colors ^[11]	ZB6DV9	ZB6CV9	ZB6AV9

For legends, see [Legend Plates and Legends](#), page 19-20

XB6 Non-Illuminated Operators

Table 19.42: Heads for Push Buttons^[12]

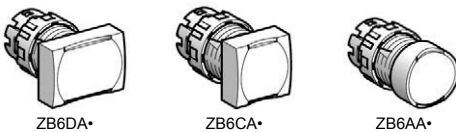

Type of Push	Color	Rectangular	Square	Round
		Catalog Number		
Flush, spring return	White	ZB6DA1	ZB6CA1	ZB6AA1
	Black	ZB6DA2	ZB6CA2	ZB6AA2
	Green	ZB6DA3	ZB6CA3	ZB6AA3
	Red	ZB6DA4	ZB6CA4	ZB6AA4
	Yellow	ZB6DA5	ZB6CA5	ZB6AA5
	Blue	ZB6DA6	ZB6CA6	ZB6AA6
	6 colors ^[13]	ZB6DA9	ZB6CA9	ZB6AA9

Table 19.43: Mushroom Heads for Trigger Action Push Buttons (30 mm)^[14]

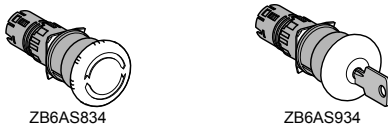

Shape of Head	Type of Push	Cap Color	Catalog Number
	Turn-to-release	Red	ZB6AS834
	Key release	Red	ZB6AS934 ^[15]

Table 19.44: Circular Legends, 45 mm



Description	Color	Text	Catalog Number
Circular legends, 45 mm	Yellow	Blank	ZB6Y7001
		Emergency stop	ZB6Y7330

[10] To combine with light modules, see XB6 Electrical Components.

[11] Six different color caps included with head (white, black, green, red, yellow, and blue).

[12] To combine with complete bodies and contact blocks, see XB6 Electrical Components, page 19-15

[13] Six different color caps included with head (white, black, green, red, yellow, and blue).

[14] Complies with ISO 13850 standards for Emergency Stop push buttons when used with circular Legend Plate ZB6Y7330

[15] Ronis 200 key



ZB6DD••



ZB6CD••



ZB6AD••

XB6 Non-Illuminated Selector Switches

Table 19.45: Heads for Non-Illuminated Selector Switches^{[16][17]}

(To combine with complete bodies and contact blocks, see [XB6 Electrical Components](#), page 19-15.)

Number and Type of Positions	Color of Handle	Rectangular	Square	Round	
		Catalog Number			
Switching angle: maintained positions 60°, spring return positions 45°					
2-maintained	↙	Black	ZB6DD22	ZB6CD22	ZB6AD22
2-maintained	↘	Black	ZB6DD28 ^[18]	ZB6CD28 ^[18]	ZB6AD28 ^[18]
3-maintained	↘↘	Black	ZB6DD23	ZB6CD23	ZB6AD23
2-spring return to center	↘↙	Black	ZB6DD24	ZB6CD24	ZB6AD24
3-spring return to center	↘↙↘	Black	ZB6DD25	ZB6CD25	ZB6AD25
3-spring return from right to center	↘↙↘	Black	ZB6DD26	ZB6CD26	ZB6AD26
3-spring return from left to center	↘↙↘	Black	ZB6DD27	ZB6CD27	ZB6AD27

Legends: [Legend Plates and Legends](#), page 19-20

[16] For bodies with 2 contact blocks, maximum.

[17] For selector switch sequence charts, see [XB6 Keyed Selector Switches](#), page 19-18.

[18] Switching angle: maintained positions 90°.

XB6 Keyed Selector Switches

Table 19.46: Heads for Ronis Key Operated Selector Switches [19]
(To combine with complete bodies and contact blocks, see XB6 Electrical Components, page 19-15.)

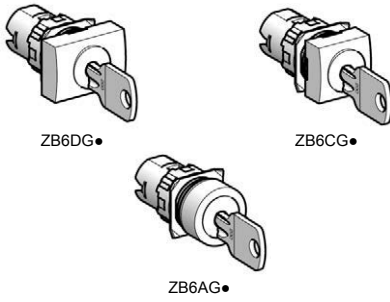

Number and Type of Positions	Key Withdrawal	Rectangular	Square	Round
		Catalog Number		
Switching angle: maintained positions 70°, spring return positions 45°				
2-maintained		ZB6DGA	ZB6CGA	ZB6AGA
		ZB6DGB	ZB6CGB	ZB6AGB
		ZB6DGC	ZB6CGC	ZB6AGC
2-spring return from right to center		ZB6DGL	ZB6CGL	ZB6AGL
3-maintained		ZB6DGD	ZB6CGD	ZB6AGD
		ZB6DGE	ZB6CGE	ZB6AGE
		ZB6DGF	ZB6CGF	ZB6AGF
		ZB6DGG	ZB6CGG	ZB6AGG
		ZB6DGH	ZB6CGH	ZB6AGH
		ZB6DGJ	ZB6CGJ	ZB6AGJ
		ZB6DGK	ZB6CGK	ZB6AGK
3-spring return from right to center		ZB6DQG	ZB6CQG	ZB6AQG
		ZB6DQR	ZB6CQR	ZB6AQR
		ZB6DQS	ZB6CQS	ZB6AQS
3-spring return to center		ZB6DGT	ZB6CGT	ZB6AGT

Indicates key withdrawal position.

Table 19.47: Selector Switch Sequence
(using contact block assemblies, see XB6 Electrical Components, page 19-15)

2 Position Selector Switch			
		Contact block guide [20]	
O	X	1 N.O. (left or right)	
X	O	1 N.C. (left or right)	
O	X	1 N.O. and 1 N.C.	
X	O		
3 Position Selector Switch			
			Contact block guide [20]
O	O	X	1 N.O. (left)
X	O	X	2 N.O. wired in parallel (side by side)
X	O	O	1 N.O. (right)
O	X	X	1 N.C. (right)
X	X	O	1 N.C. (left)
O	X	O	2 N.C. wired in series (side by side)

For legends, see Legend Plates and Legends, page 19-20

[19] Ronis 200 key standard.
[20] As viewed from the front of the panel.

XB6 Push Button Caps

Table 19.48: Push Button Caps—Marked

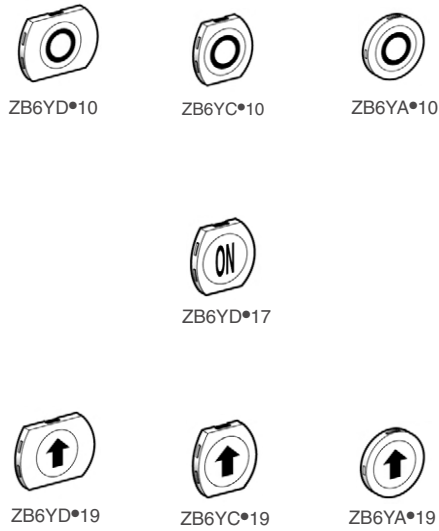

Ink Marking Color: White on colored cap Black on white cap	Color	Rectangular	Square	Round
		Catalog Number		
For non-illuminated push buttons				
0	White	ZB6YD100	ZB6YC100	ZB6YA100
	Black	ZB6YD200	ZB6YC200	ZB6YA200
1	White	ZB6YD101	ZB6YC101	ZB6YA101
	Black	ZB6YD201	ZB6YC201	ZB6YA201
2	White	ZB6YD102	ZB6YC102	ZB6YA102
	Black	ZB6YD202	ZB6YC202	ZB6YA202
3	White	ZB6YD103	ZB6YC103	ZB6YA103
	Black	ZB6YD203	ZB6YC203	ZB6YA203
4	White	ZB6YD104	ZB6YC104	ZB6YA104
	Black	ZB6YD204	ZB6YC204	ZB6YA204
5	White	ZB6YD105	ZB6YC105	ZB6YA105
	Black	ZB6YD205	ZB6YC205	ZB6YA205
6	White	ZB6YD106	ZB6YC106	ZB6YA106
	Black	ZB6YD206	ZB6YC206	ZB6YA206
7	White	ZB6YD107	ZB6YC107	ZB6YA107
	Black	ZB6YD207	ZB6YC207	ZB6YA207
8	White	ZB6YD108	ZB6YC108	ZB6YA108
	Black	ZB6YD208	ZB6YC208	ZB6YA208
9	White	ZB6YD109	ZB6YC109	ZB6YA109
	Black	ZB6YD209	ZB6YC209	ZB6YA209
ON	White	ZB6YD117	ZB6YC117	ZB6YA117
	Green	ZB6YD317	ZB6YC317	ZB6YA317
OFF	Black	ZB6YD224	ZB6YC224	ZB6YA224
	Red	ZB6YD424	ZB6YC424	ZB6YA424
I	White	ZB6YD111	ZB6YC111	ZB6YA111
	Green	ZB6YD311	ZB6YC311	ZB6YA311
O	Black	ZB6YD210	ZB6YC210	ZB6YA210
	Red	ZB6YD410	ZB6YC410	ZB6YA410
R	Black	ZB6YD226	ZB6YC226	ZB6YA226
	Blue	ZB6YD626	ZB6YC626	ZB6YA626
START	White	ZB6YD140	ZB6YC140	ZB6YA140
	Green	ZB6YD340	ZB6YC340	ZB6YA340
STOP	Black	ZB6YD241	ZB6YC241	ZB6YA241
	Red	ZB6YD441	ZB6YC441	ZB6YA441
II	White	ZB6YD112	ZB6YC112	ZB6YA112
	Black	ZB6YD212	ZB6YC212	ZB6YA212
III	White	ZB6YD113	ZB6YC113	ZB6YA113
	Black	ZB6YD213	ZB6YC213	ZB6YA213
+	White	ZB6YD114	ZB6YC114	ZB6YA114
	Black	ZB6YD214	ZB6YC214	ZB6YA214
-	White	ZB6YD115	ZB6YC115	ZB6YA115
	Black	ZB6YD215	ZB6YC215	ZB6YA215
UP	White	ZB6YD127	ZB6YC127	ZB6YA127
	Black	ZB6YD227	ZB6YC227	ZB6YA227
DOWN	White	ZB6YD128	ZB6YC128	ZB6YA128
	Black	ZB6YD228	ZB6YC228	ZB6YA228
CLOSE	White	ZB6YD132	ZB6YC132	ZB6YA132
	Black	ZB6YD232	ZB6YC232	ZB6YA232
↑	White	ZB6YD119	ZB6YC119	ZB6YA119
	Black	ZB6YD219	ZB6YC219	ZB6YA219
↓	White	ZB6YD120	ZB6YC120	ZB6YA120
	Black	ZB6YD220	ZB6YC220	ZB6YA220
→	White	ZB6YD121	ZB6YC121	ZB6YA121
	Black	ZB6YD221	ZB6YC221	ZB6YA221
←	White	ZB6YD122	ZB6YC122	ZB6YA122
	Black	ZB6YD222	ZB6YC222	ZB6YA222

Additional XB6 Accessories

Table 19.49: Accessories

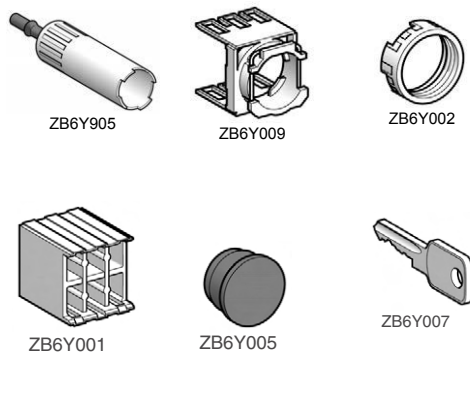

Description	Application	Catalog Number
Body	Fitting contact blocks	ZB6Y009
Bezel tightening tool + bulb extractor	Fixing the switch and changing bulbs	ZB6Y905
Three piece tool kit	—	ZB6Y019
Nut	Fixing head to panel	ZB6Y002
Adaptor	Flush mounting a circular head push button or pilot light in Ø 22 mm cut-out	ZB6YA002
Shroud	Protecting contacts against touching	ZB6Y001
Protective cover	Circular and square head push buttons and switches	ZB6YA001
	Rectangular head push buttons and switches	ZB6YD001
Female Quick connector/Solder tab	Sold in lots of 100 pieces	ZB6Y004
Blanking plug	Plugging an unused knockout	ZB6Y005
Ronis key, 2 pieces	Key operated selector switches and emergency stop mushroom	ZB6Y007
Incandescent bulbs, bayonet T1 1/4	6 V	ZB6YA006
	12 V	ZB6YJ012
	28 V [21]	ZB6YB028
Neon bulbs	110/230 V [22]	ZB6YG095

Table 19.50: Accessories for Printed Circuit Board Installations

Description	for use with	Catalog Number
Plug-in Socket Adapter	contact blocks and light modules	ZB6Y010
Body Bracket	plug-in socket adapter	ZB6Y011

XB6 Legend Plates and Legends

Table 19.51: Standard Legend Plate (24 X 28 mm) for 8 X 21 mm Legend [23]

Description	Background Color of Legend	Catalog Number
Without legend insert	—	ZB6YD20
With blank legend insert	White or yellow	ZB6YD21
	Black or red	ZB6YD22

Table 19.52: 8 x 21 mm Marked Legends (for 24 x 28 mm legend holder ZB6YD20) [23]

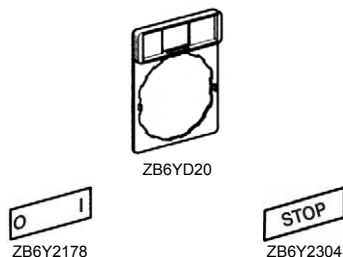

Color	Marking	Catalog Number	
White Text Red Background (Stop and Fault) Black Background (all others)	International	O-I	ZB6Y2178
		I-I	ZB6Y2179
		I-O-II	ZB6Y2186
		O	ZB6Y2190
White Text Red Background (Stop and Fault) Black Background (all others)	English	HAND-O-AUTO	ZB6Y2387
		CLOSE	ZB6Y2314
		DOWN	ZB6Y2308
		FORWARD	ZB6Y2305
		FAULT	ZB6Y2334
		LEFT	ZB6Y2310
		OFF	ZB6Y2312
		ON	ZB6Y2303
		OPEN	ZB6Y2313
		RESET	ZB6Y2323
		REVERSE	ZB6Y2306
		RIGHT	ZB6Y2309
		RUN	ZB6Y2311
		STOP	ZB6Y2304
UP	ZB6Y2307		

Table 19.53: Circular Legends, 45 mm

Description	Color	Text	Catalog Number
Circular legends, 45 mm	Yellow	Blank	ZB6Y7001
		Emergency stop	ZB6Y7330

[21] 28 V bulb supplied, for use on 24 V.

[22] 95 V bulb supplied, for use on 110/230 V.

[23] Additional legend plate sizes and markings are available in Catalog [9001CT1102](#).

New!

XB6E Flush, Spring Return Push Buttons

Table 19.54: Push Buttons, Flush, Spring Return



Shape of head	Type of contacts	Color	Sold in lots of	Catalog Number
Circular	1	White	5	XB6EAA11P
		Black	5	XB6EAA21P
		Green	5	XB6EAA31P
		Red	5	XB6EAA41P
		Yellow	5	XB6EAA51P
		Blue	5	XB6EAA61P
	2	White	5	XB6EAA12P
		Black	5	XB6EAA22P
		Green	5	XB6EAA32P
		Red	5	XB6EAA42P
		Yellow	5	XB6EAA52P
		Blue	5	XB6EAA62P
Square	1	White	5	XB6ECA11P
		Black	5	XB6ECA21P
		Green	5	XB6ECA31P
		Red	5	XB6ECA41P
		Yellow	5	XB6ECA51P
		Blue	5	XB6ECA61P
	2	White	5	XB6ECA12P
		Black	5	XB6ECA22P
		Green	5	XB6ECA32P
		Red	5	XB6ECA42P
		Yellow	5	XB6ECA52P
		Blue	5	XB6ECA62P
Rectangular	1	White	5	XB6EDA11P
		Black	5	XB6EDA21P
		Green	5	XB6EDA31P
		Red	5	XB6EDA41P
		Yellow	5	XB6EDA51P
		Blue	5	XB6EDA61P
	2	White	5	XB6EDA12P
		Black	5	XB6EDA22P
		Green	5	XB6EDA32P
		Red	5	XB6EDA42P
		Yellow	5	XB6EDA52P
		Blue	5	XB6EDA62P

New!

XB6E Pilot Lights

Table 19.55: XB6E Pilot Lights with 12 or 24 V Integral LED



Shape of head	Color	Sold in lots of	Catalog Number		
			With 12 V LED	With 24 V LED	
Circular	White	5	XB6EAV1JP	XB6EAV1BP	
	Green	5	XB6EAV3JP	XB6EAV3BP	
	Red	5	XB6EAV4JP	XB6EAV4BP	
	Yellow	5	XB6EAV5JP	XB6EAV5BP	
	Blue	5	XB6EAV6JP	XB6EAV6BP	
	Orange	5	XB6EAV8JP	XB6EAV8BP	
	Square	White	5	XB6ECV1JP	XB6ECV1BP
		Green	5	XB6ECV3JP	XB6ECV3BP
Red		5	XB6ECV4JP	XB6ECV4BP	
Yellow		5	XB6ECV5JP	XB6ECV5BP	
Blue		5	XB6ECV6JP	XB6ECV6BP	
Orange		5	XB6ECV8JP	XB6ECV8BP	
Rectangular		White	5	XB6EDV1JP	XB6EDV1BP
		Green	5	XB6EDV3JP	XB6EDV3BP
	Red	5	XB6EDV4JP	XB6EDV4BP	
	Yellow	5	XB6EDV5JP	XB6EDV5BP	
	Blue	5	XB6EDV6JP	XB6EDV6BP	
	Orange	5	XB6EDV8JP	XB6EDV8BP	

New!

XB6E Illuminated Push Buttons, Spring Return

Table 19.56: Illuminated Push Buttons, Flush, Spring Return, with 12 or 24 V Integral LED



XB6EAW...P



XB6ECW...P



XB6EDW...P

Shape of head	Type of contacts 	Color	Sold in lots of	Catalog Number	
				With 12 V LED	With 24 V LED
Circular	1	White	5	XB6EAW1J1P	XB6EAW1B1P
		Green	5	XB6EAW3J1P	XB6EAW3B1P
		Red	5	XB6EAW4J1P	XB6EAW4B1P
		Yellow	5	XB6EAW5J1P	XB6EAW5B1P
		Blue	5	XB6EAW6J1P	XB6EAW6B1P
	2	Orange	5	XB6EAW8J1P	XB6EAW8B1P
		White	5	XB6EAW1J2P	XB6EAW1B2P
		Green	5	XB6EAW3J2P	XB6EAW3B2P
		Red	5	XB6EAW4J2P	XB6EAW4B2P
		Yellow	5	XB6EAW5J2P	XB6EAW5B2P
Square	1	Blue	5	XB6EAW6J2P	XB6EAW6B2P
		Orange	5	XB6EAW8J2P	XB6EAW8B2P
		White	5	XB6ECW1J1P	XB6ECW1B1P
		Green	5	XB6ECW3J1P	XB6ECW3B1P
		Red	5	XB6ECW4J1P	XB6ECW4B1P
	2	Yellow	5	XB6ECW5J1P	XB6ECW5B1P
		Blue	5	XB6ECW6J1P	XB6ECW6B1P
		Orange	5	XB6ECW8J1P	XB6ECW8B1P
		White	5	XB6ECW1J2P	XB6ECW1B2P
		Green	5	XB6ECW3J2P	XB6ECW3B2P
Rectangular	1	Red	5	XB6ECW4J2P	XB6ECW4B2P
		Yellow	5	XB6ECW5J2P	XB6ECW5B2P
		Blue	5	XB6ECW6J2P	XB6ECW6B2P
		Orange	5	XB6ECW8J2P	XB6ECW8B2P
		White	5	XB6EDW1J1P	XB6EDW1B1P
	2	Green	5	XB6EDW3J1P	XB6EDW3B1P
		Red	5	XB6EDW4J1P	XB6EDW4B1P
		Yellow	5	XB6EDW5J1P	XB6EDW5B1P
		Blue	5	XB6EDW6J1P	XB6EDW6B1P
		Orange	5	XB6EDW8J1P	XB6EDW8B1P
Rectangular	1	White	5	XB6EDW1J2P	XB6EDW1B2P
		Green	5	XB6EDW3J2P	XB6EDW3B2P
		Red	5	XB6EDW4J2P	XB6EDW4B2P
		Yellow	5	XB6EDW5J2P	XB6EDW5B2P
		Blue	5	XB6EDW6J2P	XB6EDW6B2P
	2	Orange	5	XB6EDW8J2P	XB6EDW8B2P

New!

XB6E Illuminated Push Buttons, Latching

Table 19.57: Illuminated Push Buttons, Flush, Latching, with 12 or 24 V Integral LED



XB6EAF...P



XB6ECF...P



XB6EDF...P

Shape of Head	Type of Contacts 	Color	Sold in lots of	Catalog Number	
				With 12 V LED	With 24 V LED
Circular	1	White	5	XB6EAF1J1P	XB6EAF1B1P
		Green	5	XB6EAF3J1P	XB6EAF3B1P
		Red	5	XB6EAF4J1P	XB6EAF4B1P
		Yellow	5	XB6EAF5J1P	XB6EAF5B1P
		Blue	5	XB6EAF6J1P	XB6EAF6B1P
	2	Orange	5	XB6EAF8J1P	XB6EAF8B1P
		White	5	XB6EAF1J2P	XB6EAF1B2P
		Green	5	XB6EAF3J2P	XB6EAF3B2P
		Red	5	XB6EAF4J2P	XB6EAF4B2P
		Yellow	5	XB6EAF5J2P	XB6EAF5B2P
Square	1	Blue	5	XB6EAF6J2P	XB6EAF6B2P
		Orange	5	XB6EAF8J2P	XB6EAF8B2P
		White	5	XB6ECF1J1P	XB6ECF1B1P
		Green	5	XB6ECF3J1P	XB6ECF3B1P
		Red	5	XB6ECF4J1P	XB6ECF4B1P
	2	Yellow	5	XB6ECF5J1P	XB6ECF5B1P
		Blue	5	XB6ECF6J1P	XB6ECF6B1P
		Orange	5	XB6ECF8J1P	XB6ECF8B1P
		White	5	XB6ECF1J2P	XB6ECF1B2P
		Green	5	XB6ECF3J2P	XB6ECF3B2P
Rectangular	1	Red	5	XB6ECF4J2P	XB6ECF4B2P
		Yellow	5	XB6ECF5J2P	XB6ECF5B2P
		Blue	5	XB6ECF6J2P	XB6ECF6B2P
		Orange	5	XB6ECF8J2P	XB6ECF8B2P
		White	5	XB6EDF1J1P	XB6EDF1B1P
	2	Green	5	XB6EDF3J1P	XB6EDF3B1P
		Red	5	XB6EDF4J1P	XB6EDF4B1P
		Yellow	5	XB6EDF5J1P	XB6EDF5B1P
		Blue	5	XB6EDF6J1P	XB6EDF6B1P
		Orange	5	XB6EDF8J1P	XB6EDF8B1P
Rectangular	1	White	5	XB6EDF1J2P	XB6EDF1B2P
		Green	5	XB6EDF3J2P	XB6EDF3B2P
		Red	5	XB6EDF4J2P	XB6EDF4B2P
		Yellow	5	XB6EDF5J2P	XB6EDF5B2P
		Blue	5	XB6EDF6J2P	XB6EDF6B2P
	2	Orange	5	XB6EDF8J2P	XB6EDF8B2P



XB6ET●●●P



XB6ETN521P

New!

Table 19.58: Emergency Stop Mushroom Head Push Button

Shape of Head	Type of Push	Type of Contacts N. C.	Sold in lots of	Catalog Number	
				With 12 V LED	With 24 V LED
Illuminated					
Circular, Ø 32 mm / 1.260 in.	Trigger action, turn to release, pull to release	2	5	XB6ETI522P	XB6ETI523P
Non-Illuminated					
Circular, Ø 32 mm / 1.260 in.	Trigger action, turn to release, pull to release	2	5	XB6ETN521P	—

New!

XB6E Selector Switches

Table 19.59: Selector Switches with Standard Handle or Key Switches



XB6EAD●●●P



XB6EAG●●●P



XB6ECD●●●P



XB6ECG●●●P



XB6EDD●●●P



XB6EDG●●●P

Shape of Head	Type of push	Type of contacts CO	Number and type of positions	Sold in lots of	Catalog Number
Circular	Standard black handle	2	2-maintained	5	XB6EAD222P
		2	3-maintained	5	XB6EAD232P
		Key [24]	1	2-maintained	5
	Key [24]	2	2-maintained	5	XB6EAG222P
		2	3-maintained	5	XB6EAG232P
		Square	Standard black handle	1	2-maintained
Square	Standard black handle	2	2-maintained	5	XB6ECD222P
		2	3-maintained	5	XB6ECD232P
		Key [24]	1	2-maintained	5
	Key [24]	2	2-maintained	5	XB6ECG222P
		2	3-maintained	5	XB6ECG232P
		Rectangular	Standard black handle	1	2-maintained
2	2-maintained			5	XB6EDD222P
2	3-maintained			5	XB6EDD232P
Key [24]	1		2-maintained	5	XB6EDG221P
	2		2-maintained	5	XB6EDG222P
	2		3-maintained	5	XB6EDG232P

New!

XB6E Accessories

Table 19.60: Fast Connector Sockets

For use with	Type of Contacts CO	Sold in lots of	Catalog Number
Illuminated Push Button	1	10	ZB6YF01
	2	10	ZB6YF02
Pilot Lights	—	10	ZB6YF03
Push Button and Selector Switches	1	10	ZB6YF04
	2	10	ZB6YF05

Table 19.61: Accessories for Push Buttons

For use with	For use with	Sold in lots of	Catalog Number
Bezel Tightening tool + Bulb Extractor	Tightening and slackening the bezel changing	2	ZB6Y905
	Circle or square push buttons	1	ZB6YA001
Protective Covers	Rectangular push buttons	1	ZB6YD001
	—	10	ZB6Y005

Table 19.62: Legends for Emergency Stop Mushroom Head Push Buttons

Shape	Color	Marking	Sold in lots of	Catalog Number
Circular	Yellow	EMERGENCY STOP	10	ZB6Y56



ZB6YF●●

XB6E●● + ZB6YF●●



ZB6YA●●



ZB6YD●●



ZB6Y005

[24] Key No. 132, withdrawal from all positions. 2 keys supplied with product.

XB4 Complete Devices—Non-Illuminated

Table 19.63: Non-Illuminated Push Buttons, Momentary (screw clamp terminal connections)



Shape of Head	Type of Push	Type of Contact		Marking	Cap Color	Catalog Number	Components
		N.O.	N.C.				
	Flush	1	—	—	Black	XB4BA21	(ZB4BZ101 + ZB4BA2)
					Green	XB4BA31	(ZB4BZ101 + ZB4BA3)
					Yellow	XB4BA51	(ZB4BZ101 + ZB4BA5)
					Blue	XB4BA61	(ZB4BZ101 + ZB4BA6)
		—	1	—	Red	XB4BA42	(ZB4BZ102 + ZB4BA4)
					Black	XB4BA25	(ZB4BZ105 + ZB4BA2)
					Green	XB4BA35	(ZB4BZ105 + ZB4BA3)
					Red	XB4BA45	(ZB4BZ105 + ZB4BA4)
1	1	—	Yellow	XB4BA55	(ZB4BZ105 + ZB4BA5)		
			Blue	XB4BA65	(ZB4BZ105 + ZB4BA6)		
	Flush	1	—	"I" (white)	Green	XB4BA3311	(ZB4BZ101 + ZB4BA331)
	Flush	—	1	"O" (white)	Red	XB4BA4322	(ZB4BZ102 + ZB4BA432)
	Flush with clear silicone boot (color of pusher unobscured)	1	—	—	Black	XB4BP21	(ZB4BZ101 + ZB4BP2)
					Green	XB4BP31	(ZB4BZ101 + ZB4BP3)
					Yellow	XB4BP51	(ZB4BZ101 + ZB4BP5)
					Blue	XB4BP61	(ZB4BZ101 + ZB4BP6)
—	1	—	Red	XB4BP42	(ZB4BZ102 + ZB4BP4)		
			Red	XB4BL42	(ZB4BZ102 + ZB4BL4)		
	Extended	—	1	—	Red	XB4BL45	(ZB4BZ105 + ZB4BL4)
		1	1	—	Red	XB4BL45	(ZB4BZ105 + ZB4BL4)
	Mushroom head Ø 40 mm	1	—	—	Black	XB4BC21	(ZB4BZ101 + ZB4BC2)

Table 19.64: Two Button Push Buttons, Momentary (screw clamp terminal connections)



XB4BL73415

Shape of Head	Type of Push	Type of Contact		Marking	Degree of Protection	Catalog Number	Components
		N.O.	N.C.				
	One flush green push* One extended red push**	1	1	**"I" (white) ***"O" (white)	IP66 IP69K	XB4BL73415	(ZB4BZ105 + ZB4BL7341)

Table 19.65: Two Button Push Buttons, Momentary + one white central pilot light (screw clamp terminal connections)



XB4BL73731•5

Shape of Head	Type of Push	Type of Contact		Marking	Degree of Protection	Pilot Light Voltage	Catalog Number
		N.O.	N.C.				
	One flush green push* One extended red push** One white central pilot light block	1	1	**"I" (white) ***"O" (white)	IP66 IP69K	24 120 240	XB4BW73731B5 XB4BW73731G5 XB4BW73731M5

Table 19.66: Three Button Push Buttons, Momentary (screw clamp terminal connections)



XB4BA731327

Shape of Head	Type of Push	Type of Contact		Degree of Protection	Marking and Cap Color	Catalog Number
		N.O.	N.C.			
	Two flush pushes + one central projecting red push*	2	1	IP66 IP69K	White "I" on green background White "II" on green background *White "Stop" on red background	XB4BA731327
					Black "—" on white background White "—" on black background *White "Stop" on red background	XB4BA711237

For Legends, refer to [XB4 Legend Holders](#), page 19-38, [XB4 Legend Inserts](#), page 19-39 and [XB4 Legend Sheets](#), page 19-39.

For Caps, refer to [XB4 Accessories](#), page 19-40.

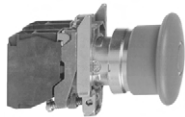

XB4BT845



XB4BS9445



XB4BS542



XB4BG33

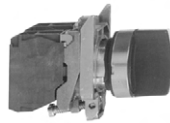

XB4BD33

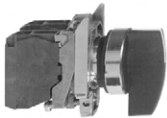

XB4BJ33

Table 19.67: Non-Illuminated Trigger Action Emergency Stop Push Buttons, Ø 40 mm, Red (screw clamp terminal connections)

Shape of Head	Type of Push	Type of Contact		Catalog Number	Components
		N.O.	N.C.		
	Trigger action push-pull [1]	1	1	XB4BT845	(ZB4BZ105 + ZB4BT84)
	Trigger action turn-to-release [1]	1	1	XB4BS8445	(ZB4BZ105 + ZB4BS844)
		1	2	XB4BS84441	(ZB4BZ141 + ZB4BS844)
	Trigger action Key release [1] (No. 455)	1	1	XB4BS9445	(ZB4BZ105 + ZB4BS944)
	Trigger action Push-pull [1]	—	1	XB4BT842	(ZB4BZ105 + ZB4BT84)
	Trigger action Turn-to-release [1]	—	1	XB4BS8442	(ZB4BZ102 + ZB4BS844)
	Trigger action Key release [1] (No. 455)	—	1	XB4BS9442	(ZB4BZ102 + ZB4BS944)

Table 19.68: Non-Illuminated Selector Switches and Key Switches (screw clamp terminal connections) [2]

Shape of Head	Type of Operator	Type of Contact		Number and Type of Positions	Catalog Number	Components
		N.O.	N.C.			
	Standard lever, black	1	—	2-maintained		XB4BD21 (ZB4BZ101 + ZB4BD2)
		1	1	2-maintained		XB4BD25 (ZB4BZ105 + ZB4BD2)
		2	—	3-maintained		XB4BD33 (ZB4BZ103 + ZB4BD3)
	Extended lever, black	1	—	3-momentary to center		XB4BD53 (ZB4BZ103 + ZB4BD5)
		2	—	2-maintained		XB4BJ21 (ZB4BZ101 + ZB4BJ2)
				3-momentary to center		XB4BJ33 (ZB4BZ103 + ZB4BJ3)
	Key (No. 455)	1	—	2-maintained		XB4BG21 (ZB4BZ101 + ZB4BG2)
				2-momentary to left		XB4BG41 (ZB4BZ101 + ZB4BG4)
		2	—	3-maintained		XB4BG61 (ZB4BZ101 + ZB4BG6)
				3-maintained		XB4BG03 (ZB4BZ103 + ZB4BG0)
					XB4BG33 (ZB4BZ103 + ZB4BG3)	

NOTE: The symbol indicates key withdrawal position(s).

For Legends, refer to [XB4 Legend Holders, page 19-38](#), [XB4 Legend Inserts, page 19-39](#) and [XB4 Legend Sheets, page 19-39](#).

[1] Trigger action mushroom heads are tamper proof in that a change of contact state is not possible by teasing or floating the operator. For emergency stop applications, always use a trigger action push button (per EN/IEC 13850).

[2] For contact configurations, see [Table 19.82 Sequence of Contacts on Selector Switch Bodies, page 19-30](#).

XB4 Complete Devices—Illuminated

Table 19.69: Pilot Lights with Protected LED™ (screw clamp terminal connections) [3]



XB4BVB5

Shape of Head	Supply Voltage	Color	Catalog Number	Components
	24 Vac/Vdc	White	XB4BVB1	(ZB4BVB1 + ZB4BV013)
		Green	XB4BVB3	(ZB4BVB3 + ZB4BV033)
		Red	XB4BVB4	(ZB4BVB4 + ZB4BV043)
		Yellow	XB4BVB5	(ZB4BVB5 + ZB4BV053)
		Blue	XB4BVB6	(ZB4BVB6 + ZB4BV063)
		White	XB4BVG1	(ZB4BVG1 + ZB4BV013)
	110–120 Vac	Green	XB4BVG3	(ZB4BVG3 + ZB4BV033)
		Red	XB4BVG4	(ZB4BVG4 + ZB4BV043)
		Yellow	XB4BVG5	(ZB4BVG5 + ZB4BV053)
		Blue	XB4BVG6	(ZB4BVG6 + ZB4BV063)

Table 19.70: Pilot Lights for BA9s Bulb (screw clamp terminal connections)



XB4BV64

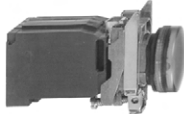

XB4BV33

Shape of Head	Supply Voltage	Color	Catalog Number	Components
Direct supply, for BA9s (incandescent, LED, neon) V < 250 V, 2.4 W bulb (bulb not included)				
	< 250 Vac/Vdc	White	XB4BV61	(ZB4BV6 + ZB4BV01)
		Green	XB4BV63	(ZB4BV6 + ZB4BV03)
		Red	XB4BV64	(ZB4BV6 + ZB4BV04)
		Yellow	XB4BV65	(ZB4BV6 + ZB4BV05)
Transformer type with 1.2 VA, 6 V secondary. BA9s incandescent bulb included				
	110–120 Vac 50/60 Hz	White	XB4BV31	(ZB4BV3 + ZB4BV01)
		Green	XB4BV33	(ZB4BV3 + ZB4BV03)
		Red	XB4BV34	(ZB4BV3 + ZB4BV04)
		Yellow	XB4BV35	(ZB4BV3 + ZB4BV05)

Table 19.71: Illuminated Push Buttons, Momentary (screw clamp terminal connections) [3]

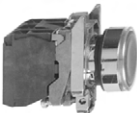

XB4BW33B5



XB4BW3465



XB4BW3545

Shape of Head	Description	Type of Contact		Supply Voltage	Color of Push	Catalog Number	Components					
		N.O.	N.C.									
Flush												
	Protected LED	1	1	24 Vac/Vdc	White	XB4BW31B5	(ZB4BW0B15 + ZB4BW313)					
					Green	XB4BW33B5	(ZB4BW0B35 + ZB4BW333)					
					Red	XB4BW34B5	(ZB4BW0B45 + ZB4BW343)					
					Yellow	XB4BW35B5	(ZB4BW0B55 + ZB4BW353)					
					Blue	XB4BW36B5	(ZB4BW0B65 + ZB4BW363)					
					110–120 Vac	White	XB4BW31G5	(ZB4BW0G15 + ZB4BW313)				
						Green	XB4BW33G5	(ZB4BW0G35 + ZB4BW333)				
						Red	XB4BW34G5	(ZB4BW0G45 + ZB4BW343)				
				Yellow		XB4BW35G5	(ZB4BW0G55 + ZB4BW353)					
				Blue		XB4BW36G5	(ZB4BW0G65 + ZB4BW363)					
				< 250 Vac/Vdc		White	XB4BW3165	(ZB4BW065 + ZB4BW31)				
					Green	XB4BW3365	(ZB4BW065 + ZB4BW33)					
					Red	XB4BW3465	(ZB4BW065 + ZB4BW34)					
					Yellow	XB4BW3565	(ZB4BW065 + ZB4BW35)					
110–120 Vac 50/60 Hz	White	XB4BW3135	(ZB4BW035 + ZB4BW31)									
	Green	XB4BW3335	(ZB4BW035 + ZB4BW33)									
	Red	XB4BW3435	(ZB4BW035 + ZB4BW34)									
	Yellow	XB4BW3535	(ZB4BW035 + ZB4BW35)									
	230–240 Vac 50/60 Hz	White	XB4BW3145	(ZB4BW045 + ZB4BW31)								
		Green	XB4BW3345	(ZB4BW045 + ZB4BW33)								
Red		XB4BW3445	(ZB4BW045 + ZB4BW34)									
	Transformer type 1.2 VA, 6 V secondary. BA9s incandescent bulb included	1	1	110–120 Vac 50/60 Hz	White	XB4BW3135	(ZB4BW035 + ZB4BW31)					
					Green	XB4BW3335	(ZB4BW035 + ZB4BW33)					
					Red	XB4BW3435	(ZB4BW035 + ZB4BW34)					
					Yellow	XB4BW3535	(ZB4BW035 + ZB4BW35)					
					230–240 Vac 50/60 Hz	White	XB4BW3145	(ZB4BW045 + ZB4BW31)				
						Green	XB4BW3345	(ZB4BW045 + ZB4BW33)				
				Red		XB4BW3445	(ZB4BW045 + ZB4BW34)					
					Extended	1	1	24 Vac/Vdc	White	XB4BW11B5	(ZB4BW0B15 + ZB4BW113)	
									Green	XB4BW13B5	(ZB4BW0B35 + ZB4BW133)	
									Red	XB4BW14B5	(ZB4BW0B45 + ZB4BW143)	
									Yellow	XB4BW15B5	(ZB4BW0B55 + ZB4BW153)	
									Blue	XB4BW16B5	(ZB4BW0B65 + ZB4BW163)	
									110–120 Vac	White	XB4BW11G5	(ZB4BW0G15 + ZB4BW113)
										Green	XB4BW13G5	(ZB4BW0G35 + ZB4BW133)
Red	XB4BW14G5	(ZB4BW0G45 + ZB4BW143)										
Yellow	XB4BW15G5	(ZB4BW0G55 + ZB4BW153)										
Blue	XB4BW16G5	(ZB4BW0G65 + ZB4BW163)										

For legends, refer to XB4 Legend Holders, page 19-38, XB4 Legend Inserts, page 19-39, and XB4 Legend Sheets, page 19-39.

[3] For 240 V LED, replace the last “B” or “G” in the catalog number with an “M”. For example, XB4BVB1 (24 V) becomes XB4BVM1 (240 V—AC only).

XB4 Operators

Table 19.72: Non-Illuminated Operators, Momentary—Unmarked



Shape of Head	Type of Push	Cap Color	Catalog Number
	Flush, without color cap [4]	—	ZB4BA0
	Flush, with set of 6 color caps	White Black Green Red Yellow Blue	ZB4BA9
	Flush	White Black Green Red Yellow Blue Gray	ZB4BA1 ZB4BA2 ZB4BA3 ZB4BA4 ZB4BA5 ZB4BA6 ZB4BA8
	Flush with transparent cap, for insertion of legend [5]	White Green Red Yellow Blue	ZB4BA18 ZB4BA38 ZB4BA48 ZB4BA58 ZB4BA68
	Booted Flush (clear silicone) Cap color unobscured	White Black Green Red Yellow Blue	ZB4BP1 ZB4BP2 ZB4BP3 ZB4BP4 ZB4BP5 ZB4BP6
	Booted Extended (clear silicone) Cap color unobscured	White Black Green Red Yellow Blue	ZB4BP1 ZB4BP2 ZB4BP3 ZB4BP4 ZB4BP5 ZB4BP6
	Booted (colored silicone) Cap color unobscured	White Black Green Red Yellow Blue	ZB4BP1S ZB4BP2S ZB4BP3S ZB4BP4S ZB4BP5S ZB4BP6S
	Booted (clear silicone) for insertion of legend [5] Cap color unobscured	White Green Red Yellow Blue	ZB4BP18 ZB4BP38 ZB4BP48 ZB4BP58 ZB4BP68
	Extended	White Black Green Red Yellow Blue	ZB4BL1 ZB4BL2 ZB4BL3 ZB4BL4 ZB4BL5 ZB4BL6
	Guarded Head	White Black Green Red Yellow Blue	ZB4BA16 ZB4BA26 ZB4BA36 ZB4BA46 ZB4BA56 ZB4BA66

Table 19.73: Non-Illuminated Operators, Momentary—Premarked



Shape of Head	Type of Push	Marking Text	Marking Color	Cap Color	Catalog Number	
	Flush	I	White	Green	ZB4BA331	
			Black	White	ZB4BA131	
		START	White	Green	ZB4BA333	
			Black	White	ZB4BA133	
		ON	White	Green	ZB4BA341	
			Black	White	ZB4BA141	
		RESET	White	Black	ZB4BA222	
		JOG	White	Black	ZB4BA245	
		O	White	Red	ZB4BA432	
		STOP	White	Black	Red	ZB4BA232
				Red	Black	ZB4BA434
		OFF	White	Red	Black	ZB4BA234
				Black	Red	ZB4BA435
↑ [6]	White	Black	White	ZB4BA235		
		White	Black	ZB4BA335		
	Extended	O	White	Red	ZB4BL432	
			Black	Red	ZB4BL232	
		STOP	White	Red	Black	ZB4BL434
				Black	Red	ZB4BL234
		OFF	White	Red	ZB4BL435	
Black	Red	ZB4BL235				

For Legends, refer to [XB4 Legend Holders](#), page 19-38, [XB4 Legend Inserts](#), page 19-39, and [XB4 Legend Sheets](#), page 19-39.

[4] Color cap to be ordered separately, see [XB4 Accessories](#), page 19-40.
 [5] For legend ordering information, see [XB4 Legend Sheets](#), page 19-39.
 [6] Cap supplied not clipped-in, allowing orientation of arrow in any one of 4 directions:



Table 19.74: Non-Illuminated Push-on/Push-off Operators

Shape of Head	Type of Push	Color of Push	Catalog Number
	Flush	White	ZB4BH01
		Black	ZB4BH02
		Green	ZB4BH03
		Red	ZB4BH04
		Yellow	ZB4BH05
		Blue	ZB4BH06
	Extended	White	ZB4BH1
		Black	ZB4BH2
		Green	ZB4BH3
		Red	ZB4BH4
		Yellow	ZB4BH5
		Blue	ZB4BH6

Table 19.75: Three Head Operators, Momentary



Shape of Head	Description	Marking	Cap Color	Degree of Protection	Catalog Number
Premarked					
	Two flush + one central projecting red push marked "Stop"	"I" (white)	Green	IP66 IP69K	ZB4BA73132
		"II" (white)	Green		ZB4BA73133
		"=" (white)	Green		ZB4BA73134
		"#" (white)	Green		ZB4BA73135
		"+" (white)	Green		ZB4BA71115
		"-" (white)	White		ZB4BA71123
		"=" (black)	White		ZB4BA71124
		"#" (black)	Black		
		"#" (white)	Black		
Without caps					
	Two flush without caps	—	—	IP66 IP69K	ZB4BA791

Table 19.76: Two Head Operators, Momentary



Shape of Head	Description	Marking	Cap Color	Degree of Protection	Catalog Number
No Marking					
	Two flush	—	Green Red	IP66 IP69K	ZB4BA7340
		—	White Black		ZB4BA7120
	One flush One extended	—	Green Red		ZB4BL7340
Premarked					
	Two flush	"I" (white)	Green	IP66 IP69K	ZB4BA7341
		"O" (white)	Red		ZB4BA7121
	One flush One extended	"I" (white)	Green		ZB4BL7341
		"O" (white)	Red		
Without caps					
	Two flush without caps	—	—	IP66 IP69K	ZB4BA79

For Legends, refer to [XB4 Legend Holders, page 19-38](#), [XB4 Legend Inserts, page 19-39](#), and [XB4 Legend Sheets, page 19-39](#).

XB4 Operators and Emergency Stop Operators

Table 19.77: Mushroom Heads, Momentary



Shape of Head	Diameter of Head	Color of Head	Catalog Number
	30 mm	Black	ZB4BC24
		Green	ZB4BC34
		Red	ZB4BC44
		Yellow	ZB4BC54
		Blue	ZB4BC64
		Black	ZB4BC2
	40 mm	Green	ZB4BC3
		Red	ZB4BC4
		Yellow	ZB4BC5
		Blue	ZB4BC6
		Black	ZB4BR2
		Green	ZB4BR3
60 mm	Red	ZB4BR4	
	Yellow	ZB4BR5	
	Blue	ZB4BR6	

Table 19.78: Mushroom Heads for Maintained Push Buttons



Shape of Head	Type of Push	Diameter of Head	Color	Catalog Number
For use in Emergency Stop applications				
	Trigger action Push-pull [7]	40 mm	Red	ZB4BT84
		60 mm	Red	ZB4BX84
	Trigger action Turn-to-release [7]	30 mm	Red	ZB4BS834
		40 mm	Red	ZB4BS844
		40 mm	Red marked "EMO"	ZB4BS84430
		60 mm	Red	ZB4BS864
	Trigger action Key release (No. 455) [7]	30 mm	Red	ZB4BS934
		40 mm	Red	ZB4BS944 [8]
		60 mm	Red	ZB4BS964
For use in non-Emergency Stop applications				
	Push-pull	40 mm	Black	ZB4BT2
		60 mm	Black	ZB4BX2
	Turn-to-release	30 mm	Black	ZB4BS42
		40 mm	Black	ZB4BS52
			Yellow	ZB4BS55
			Yellow marked "Robot Stop"	ZB4BS5550
		60 mm	Black	ZB4BS62
	Key release (No. 455)	30 mm	Black	ZB4BS72
		40 mm	Black	ZB4BS12
		60 mm	Black	ZB4BS22

Table 19.79: Circular Legends for Emergency Stop Mushroom Heads (yellow background)

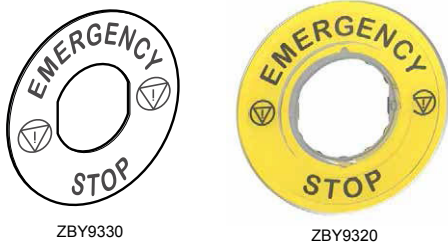

Diameter	Text	Catalog Number
60 mm	Blank	ZBY9101
	EMERGENCY STOP	ZBY9330
90 mm	Blank	ZBY8101
	EMERGENCY STOP	ZBY8330
60 mm Bezeled	Blank	ZBY9121
	Emergency Stop	ZBY9320
	Prada de Emergencia	ZBY9420
	Not Halt	ZBY9220

For Legends, refer to XB4 Legend Holders, page 19-38, XB4 Legend Inserts, page 19-39, and XB4 Legend Sheets, page 19-39.

[7] Trigger action mushroom heads are tamper proof in that a change of contact state is not possible by teasing or floating the operator. For emergency stop applications, always use a trigger action push button (per EN/IEC 13850).

[8] Other key numbers:

- key no. 421E: add the suffix 12 to the catalog number.
- key no. 458A: add the suffix 10 to the catalog number.
- key no. 520E: add the suffix 14 to the catalog number.
- key no. 3131A: add the suffix 20 to the catalog number.

Example: The catalog number for a Ø 40 mm red mushroom head for a trigger action, maintained push button, with release by key no. 421E becomes: ZB5AS94412.

XB4 Selector Switches

Table 19.80: Non-Illuminated Selector Switches [9]

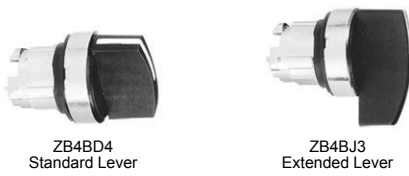

Color	Number and Type of Positions		Standard Lever [10]	Extended Lever
			Catalog Number	
Black	2-maintained		ZB4BD2	ZB4BJ2
Black	2-momentary from right to left		ZB4BD4	ZB4BJ4
Black	3-maintained		ZB4BD3	ZB4BJ3
Black	3-momentary to center		ZB4BD5	ZB4BJ5
Black	3-momentary from left to center		ZB4BD7	ZB4BJ7
Black	3-momentary from right to center		ZB4BD8	ZB4BJ8

Table 19.81: Non-Illuminated Key Switches [9]



Type of Operator	Number and Type of Positions		Catalog Number
2-maintained			ZB4BG2
			ZB4BG02
			ZB4BG4
2-momentary from right to left			ZB4BG6
3-maintained			ZB4BG0
			ZB4BG3
			ZB4BG03
			ZB4BG04
			ZB4BG5
			ZB4BG9
			ZB4BG09
			ZB4BG1
			ZB4BG01
3-momentary from left to center			ZB4BG7
3-momentary to center			ZB4BG8
			ZB4BG05
			ZB4BG08

Key (No. 455)

NOTE: The symbol indicates key withdrawal position(s).

Other key numbers:

- key no. 421E: add the suffix 12 to the catalog number.
- key no. 458A: add the suffix 10 to the catalog number.
- key no. 520E: add the suffix 14 to the catalog number.
- key no. 3131A: add the suffix 20 to the catalog number.
- key no. 8D1: add the suffix D to the catalog number.

Example: The catalog number for a head with key no. 421E for a 2 position maintained, lockable selector switch, with key withdrawal from the left-hand position, becomes: ZB5AG212

Table 19.82: Sequence of Contacts on Selector Switch Bodies

Unit Type	Selector Switches													
	2-position						3-position							
	315°		45°		315°		0°		45°					
<p>Note: L=Left, C=Center, R=Right, O=Open, X=Closed</p>														
Operator Plunger Position	Up	[Diagram]		[Diagram]		[Diagram]		[Diagram]		[Diagram]		[Diagram]		
	Down	[Diagram]		[Diagram]		[Diagram]		[Diagram]		[Diagram]		[Diagram]		
Contact Block Location	L	C	R	L	C	R	L	C	R	L	C	R		
Contacts	N.O.	O	O	O	X	X	X	X	X	O	O	O	X	X
	N.C.	X	X	X	O	O	O	O	O	X	X	X	X	O

For Legends, refer to [XB4 Legend Holders](#), page 19-38, [XB4 Legend Inserts](#), page 19-39, and [XB4 Legend Sheets](#), page 19-39.

For Selector Switch Sequence, refer to [Table 19.96 Sequence of Contacts on Illuminated Selector Switch Bodies](#), page 19-34.

[9] For contact configurations, see [Table 19.82 Sequence of Contacts on Selector Switch Bodies](#), page 19-30.

[10] For colored lever, add the following code to the end of part number: 01–white, 03–green, 04–red, 05–yellow, 06–blue (Example: ZB4BD204).

XB4 Specialty Operators

Table 19.83: Potentiometer Operator (with Mounting Collar)

Shape of Head	Description	Application	Catalog Number
	For potentiometer with shaft length 1.73 to 1.97 in. (45 to 50 mm) (potentiometer not included)	For shaft Ø 1/4 in. (6.35 mm)	ZB4BD922
		For shaft Ø 0.24 in. (6 mm)	ZB4BD912

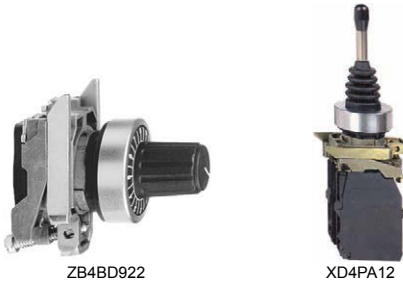

Table 19.84: Joysticks (54 mm, Extended Operating Shaft) [11]



Description	Contact Operation	Action	Catalog Number
2 direction 	1 step 1 N.O. contact per direction	Maintained	XD4PA12
		Momentary	XD4PA22
4 direction 	1 step 1 N.O. contact per direction	Maintained	XD4PA14
		Momentary	XD4PA24

Table 19.85: Legends for Joysticks



Description	For use with	Color	Catalog Number
Legends 30 x 48 mm for customer engraving	2 direction	Black one side Red reverse	ZBG2201
		White one side Yellow reverse	ZBG2401
Legends 48 x 48 mm for customer engraving	4 direction	Black one side Red reverse	ZBG4201
		White one side Yellow reverse	ZBG4401

Table 19.86: Two Position Toggle Switch

Shape of Head	Color	Type of Positions	Catalog Number
	Black	Maintained	ZB4BD28
	Black	Momentary	ZB4BD48



Table 19.87: Reset Operators, Flush, Adjustable Shaft

Shape of Head	Travel		Actuation Distance		Color	Catalog Number
	in.	mm	in.	mm		
	0.39	10	0.24–0.63	6–16	Black	XB4BA821
					Red	XB4BA841
					Blue	XB4BA861
			0.63–1.02	16–26	Black	XB4BA822
					Red	XB4BA842
					Blue	XB4BA862
	0.55	14	1.18–5.12	30–130	Black	XB4BA921
					Red	XB4BA941
					Blue	XB4BA961
			5.12–10.12	130–257	Black	XB4BA922
					Red	XB4BA942
					Blue	XB4BA962

For Legends, refer to XB4 Legend Holders, page 19-38, XB4 Legend Inserts, page 19-39, and XB4 Legend Sheets, page 19-39.

[11] Do not use standard contact blocks ZBE10• (single) or ZBE20• (double).

XB4 Pilot Lights

Table 19.88: Pilot Light Heads



Shape of Head	For Use with Body Comprising Light Module Type	Color of Lens	Catalog Number
	Protected LED™ only	White Green Red Yellow Blue	ZB4BV013 ZB4BV033 ZB4BV043 ZB4BV053 ZB4BV063
	Protected LED only Fresnel (jeweled) lens [12]	White Green Red Amber Blue	ZB4BV013S ZB4BV033S ZB4BV043S ZB4BV053S ZB4BV063S
	For BA9s incandescent bulb, neon or LED only [13]	White Green Red Yellow Blue Clear	ZB4BV01 ZB4BV03 ZB4BV04 ZB4BV05 ZB4BV06 ZB4BV07
	For BA9s incandescent bulb, neon or LED Fresnel (jeweled) lens [13]	White Green Red Amber Blue Clear	ZB4BV01S ZB4BV03S ZB4BV04S ZB4BV05S ZB4BV06S ZB4BV07S

Table 19.89: Complete Bodies (Mounting Collar + Light Module for BA9s Incandescent Bulb, Neon or LED)



Description	Light Source	Supply Voltage (V)	Catalog Number
Screw clamp terminal connections			
Direct supply	BA9s bulb 2.4 W max. Not included [13]	<250	ZB4BV6
Direct supply	BA9s incandescent bulb included	24 v 2 Watt	ZB4BV624
Direct supply	BA9s incandescent bulb included	120 v 2.4 Watt	ZB4BV6120
Transformer type 1.2 VA, 6 V secondary	BA9s incandescent bulb included	110–120 Vac 50/60 Hz	ZB4BV3
		230–240 Vac 50/60 Hz	ZB4BV4
		400–50 Hz	ZB4BV5
		440–480 Vac 60 Hz	ZB4BV8
		550–600 Vac 60 Hz	ZB4BV9

Table 19.90: Complete Bodies (Mounting Collar + Light Module with Protected LED™) [14]

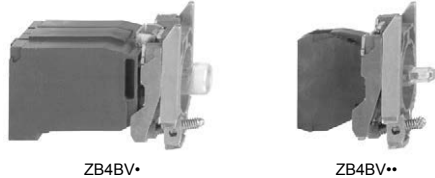

Light Source	Supply Voltage	Color of Light Source	Catalog Number
Screw clamp terminal connections [15]			
	12 Vac/Vdc	White Green Red Yellow Blue	ZB4BVJ1 ZB4BVJ3 ZB4BVJ4 ZB4BVJ5 ZB4BVJ6
	24 Vac/Vdc	White Green Red Yellow Blue	ZB4BVB1 ZB4BVB3 ZB4BVB4 ZB4BVB5 ZB4BVB6
	24–120 Vac/Vdc	White Green Red Yellow Blue	ZB4BVBG1 ZB4BVBG3 ZB4BVBG4 ZB4BVBG5 ZB4BVBG6
	110–120 Vac	White Green Red Yellow Blue	ZB4BVG1 ZB4BVG3 ZB4BVG4 ZB4BVG5 ZB4BVG6
	24 Vac/Vdc	White Green Red Yellow Blue	ZB4BV18B1 ZB4BV18B3 ZB4BV18B4 ZB4BV18B5 ZB4BV18B6
	110–120 Vac	White Green Red Yellow Blue	ZB4BV18G1 ZB4BV18G3 ZB4BV18G4 ZB4BV18G5 ZB4BV18G6

For Legends, refer to XB4 Legend Holders, page 19-38, XB4 Legend Inserts, page 19-39 and XB4 Legend Sheets, page 19-39.

[12] For use in bright ambient conditions, for example, in sunlight.

[13] Order bulb separately; see Table 19.118 BA9s Bulbs and Associated Accessories, page 19-41. For BA9 LED, see Table 19.403 LED, BA9s Base, page 19-129.

[14] For 240 V LED, replace the last "B" or "G" in the catalog number with an "M". For example, ZB4BVB1 (24 V) becomes ZB4BVM1 (240 V).

[15] For Quick-Connect version, add "3" to the end of the catalog number Example: ZB4BVJ13 (Quick-Connect size 1 x 1/40" or 2 x 0.110").

XB4 Illuminated Operators

Table 19.91: Heads for Momentary Illuminated Push Buttons



Shape of Head	Type of Push	Color	Catalog Number
Only use with Protected LED™ light modules			
	Flush	White	ZB4BW313
		Green	ZB4BW333
		Red	ZB4BW343
		Yellow	ZB4BW353
		Blue	ZB4BW363
	Flush with clear silicone boot	White	ZB4BW513
		Green	ZB4BW533
		Red	ZB4BW543
		Yellow	ZB4BW553
		Blue	ZB4BW563
	Flush for insertion of legend	White	ZB4BA18
		Green	ZB4BA38
		Red	ZB4BA48
		Yellow	ZB4BA58
		Blue	ZB4BA68
	Extended	White	ZB4BW113
		Green	ZB4BW133
		Red	ZB4BW143
		Yellow	ZB4BW153
		Blue	ZB4BW163
	Mushroom (40 mm)	Clear	ZB4BW413
		Green	ZB4BW433
		Red	ZB4BW443
		Yellow	ZB4BW453
		Blue	ZB4BW463
Only use with light modules for a BA9s incandescent bulb, neon or LED			
	Flush	White	ZB4BW31
		Green	ZB4BW33
		Red	ZB4BW34
		Yellow	ZB4BW35
		Blue	ZB4BW36
		Clear	ZB4BW37
	Extended	White	ZB4BW11
		Green	ZB4BW13
		Red	ZB4BW14
		Yellow	ZB4BW15
		Blue	ZB4BW16
		Clear	ZB4BW17

Table 19.92: Heads for Maintained Illuminated Push Buttons



Shape of Head	Type of Push	Color of Lens	Catalog Number
Only use with Protected LED light modules			
	Push/Pull Mushroom (40 mm)	Clear	ZB4BW613
		Green	ZB4BW633
		Red	ZB4BW643
		Yellow	ZB4BW653
		Blue	ZB4BW663

Table 19.93: Illuminated Push-On/Push-Off Operators



Shape of Head	Type of Push	Color of Lens	Catalog Number
Only use with Protected LED light modules			
	Flush	White	ZB4BH013
		Green	ZB4BH033
		Red	ZB4BH043
		Yellow	ZB4BH053
		Blue	ZB4BH063
	Extended	White	ZB4BH13
		Green	ZB4BH33
		Red	ZB4BH43
		Yellow	ZB4BH53
		Blue	ZB4BH63

For Legends, refer to XB4 Legend Holders, page 19-38, XB4 Legend Inserts, page 19-39 and XB4 Legend Sheets, page 19-39.









ZB4BW7A3741



ZB4BW7A1721

Table 19.94: Two Button with Clear Pilot Light, Momentary

Shape of Head	Description	Marking	Cap Color	Degree of Protection	Catalog Number	
No Marking						
	Two flush	—	Green Red	IP66 IP69K	ZB4BW7A3740	
		—	White Black		ZB4BW7A1720	
	One flush One extended	—	Green Red		ZB4BW7L3740	
		Premarked				
	Two flush	"I" (white) "O" (white)	Green Red		ZB4BW7A3741	
		"I" (black) "O" (white)	White Black		ZB4BW7A1721	
	One flush One extended	"I" (white) "O" (white)	Green Red	ZB4BW7L3741		
			Two flush	"+" (black) "-" (white)	White Black	ZB4BW7A1724
	Two flush			"+" (black) "-" (white)	White Black	ZB4BW7A1715
		Without caps				
	Two flush without caps	—	—	IP66 IP69K	ZB4BW7A9	



ZB4BK1343

Table 19.95: Illuminated Selector Switches, Standard Lever













Shape of Head	Number and Type of Positions	Catalog Number [16]
Only use with Protected LED light modules		
	2-maintained	ZB4BK12•3
	2-momentary from right to left	ZB4BK14•3
	3-maintained	ZB4BK13•3
	3-momentary to center	ZB4BK15•3
	3-momentary from right to center	ZB4BK18•3
	3-momentary from left to center	ZB4BK17•3

Table 19.96: Sequence of Contacts on Illuminated Selector Switch Bodies

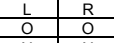
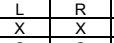
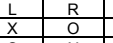
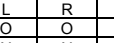
Unit Type	Selector Switches						
	2-position		3-position				
	315°	45°	315°	0°	45°		
Operator Plunger Position	Up						
	Down						
Contact Block Location	L	R	L	R	L	R	
	N.O.	O	O	X	X	O	O
Contacts	N.C.	X	X	O	O	X	X
		X	X	O	O	X	X

Note: L=Left, R=Right, O=Open, X=Closed

2 Position Selector Switch			3 Position Selector Switch		
		Contact block guide			Contact block guide
O	X	1 N.O. (left or right)	O	O	1 N.O. (left)
X	O	1 N.C. (left or right)	X	O	2 N.O. wired in parallel (side by side)
O	X	1 N.O. and	X	O	1 N.O. (right)
X	O	1 N.C.	O	X	1 N.C. (right)
			X	X	1 N.C. (left)
			O	X	2 N.C. wired in series (side by side)

For Legends, refer to [XB4 Legend Holders](#), page 19-38, [XB4 Legend Inserts](#), page 19-39, and [XB4 Legend Sheets](#), page 19-39.

For Caps, refer to [XB4 Accessories](#), page 19-40.

[16] • Designate color as follows: 1—white, 3—green, 4—red, 5—yellow, 6—blue.

XB4 Electrical Components

Table 19.97: Contact Blocks (Mounting Collar with Contact Blocks)



Description	Type of Contact		Catalog Number
	N.O.	N.C.	
Screw clamp terminal connections	1	—	ZB4BZ101
	—	1	ZB4BZ102
	2	—	ZB4BZ103
	—	2	ZB4BZ104
	1	1	ZB4BZ105
	1	2	ZB4BZ141

For Quick-Connect version add "3" to the end of the catalog number Example: ZB4BZ1013 (Quick-Connect size 1 x 0.250" or 2 x 0.110").

For Ring Tongue compatible blocks add "9" to the end of the catalog number (Example: ZB4BZ1029).

Electrical components with connection by printed circuit board pins are available. Refer to Catalog 9001CT0001.

Electrical components with connection by plug-in connector are available. Refer to Catalog 9001CT0001.

Table 19.98: Complete Bodies

(Mounting Collar + Single Contact Block + Light Module with Protected LED™)



Light Source	Type of Contact [17]		Color	Supply Voltage [18]	
	N.O.	N.C.		24 Vac/Vdc	110–120 Vac
Screw clamp terminal connections					
Protected LED	1	—	White	ZB4BW0B11	ZB4BW0G11
			Green	ZB4BW0B31	ZB4BW0G31
			Red	ZB4BW0B41	ZB4BW0G41
			Yellow	ZB4BW0B51	ZB4BW0G51
			Blue	ZB4BW0B61	ZB4BW0G61
	—	1	White	ZB4BW0B12	ZB4BW0G12
			Green	ZB4BW0B32	ZB4BW0G32
			Red	ZB4BW0B42	ZB4BW0G42
			Yellow	ZB4BW0B52	ZB4BW0G52
			Blue	ZB4BW0B62	ZB4BW0G62
	2	—	White	ZB4BW0B13	ZB4BW0G13
			Green	ZB4BW0B33	ZB4BW0G33
			Red	ZB4BW0B43	ZB4BW0G43
			Yellow	ZB4BW0B53	ZB4BW0G53
			Blue	ZB4BW0B63	ZB4BW0G63
	1	1	White	ZB4BW0B15	ZB4BW0G15
			Green	ZB4BW0B35	ZB4BW0G35
			Red	ZB4BW0B45	ZB4BW0G45
			Yellow	ZB4BW0B55	ZB4BW0G55
			Blue	ZB4BW0B65	ZB4BW0G65

Table 19.99: Mounting Collar, Contact Block and Light Module (with screw clamp terminal connections)



Supply	Light Source	Supply Voltage	Type of Contact [19]		Color of Light Source	Catalog Number
			N.O.	N.C.		
Screw clamp terminal connections						
Direct supply	BA9s 2.4 W max. bulb Not included [20]	< 250 Vac/Vdc	1	—	—	ZB4BW061
			—	1	—	ZB4BW062
			2	—	—	ZB4BW063
			1	1	—	ZB4BW065
Transformer type 1.2 VA, 6 V secondary	BA9s incandescent bulb included	110–120 Vac 50/60 Hz	1	—	—	ZB4BW031
			1	1	—	ZB4BW035
		230–240 Vac 50/60 Hz	1	—	—	ZB4BW041
			1	1	—	ZB4BW045
		440–480 Vac 60 Hz	1	—	—	ZB4BW081
			1	1	—	ZB4BW085

[17] Can be fitted with additional contact blocks, see Table 19.101 Add-On Contact Block (with screw clamp terminal connections), page 19-36.

[18] For 240V LED, replace the "B" or "G" with "M". (Example: change "ZB4BW0B11 (24V)" to ZB4BW0M11 (240V))

[19] Can be fitted with additional contact blocks, see Table 19.101 Add-On Contact Block (with screw clamp terminal connections), page 19-36.

[20] Order bulb separately, see BA9s Bulbs and Associated Accessories.



ZB4BZ009



ZBE101



ZBE203



ZBVB

Table 19.100: Body/Mounting Collar

For use with	Catalog Number
Electrical block (contact or light module)	ZB4BZ009

Table 19.101: Add-On Contact Block (with screw clamp terminal connections) [21]

[22]

Description	Type of Contact		Catalog Number	
	N.O.	N.C.		
Standard single contact blocks [23][24]	1	—	ZBE101	
	—	1	ZBE102	
Standard double contact blocks [23][24]	2	—	ZBE203	
	—	2	ZBE204	
	1	1	ZBE205	
	1	—	ZBE1016	
Special contact blocks for low power switching [25]	—	1	ZBE1026	
	1	—	ZBE1016P	
Low-power switching	Dusty environment [25] (IP5X, 50 µm dust)	—	ZBE1026P	
	—	1	ZBE201	
Staggered contacts	Early make N.O.	—	ZBE201	
	Late break N.C.	—	1	ZBE202
	Overlapping N.O.+N.C.	1	1	ZB4BZ106
	Staggered N.O.+N.C.	—	2	ZB4BZ107

Table 19.102: Light Modules (with screw clamp terminal connections) [21][22]

Description	Supply Voltage	Color of Light Source	Catalog Number
Protected LED	12 Vac/Vdc	White	ZBVJ1
		Green	ZBVJ3
		Red	ZBVJ4
		Yellow	ZBVJ5
		Blue	ZBVJ6
		White	ZBVB1
	24 Vac/Vdc	Green	ZBVB3
		Red	ZBVB4
		Yellow	ZBVB5
		Blue	ZBVB6
		White	ZBVG1
		Green	ZBVG3
	110–120 Vac	Red	ZBVG4
		Yellow	ZBVG5
		Blue	ZBVG6
		White	ZBVG1
		Green	ZBVG3
		Red	ZBVG4
	24–120 Vac/Vdc	Yellow	ZBVG5
		Blue	ZBVG6
		White	ZBVM1
		Green	ZBVM3
		Red	ZBVM4
		Yellow	ZBVM5
230–240 Vac	Blue	ZBVM6	
	White	ZBVM1	
	Green	ZBVM3	
	Red	ZBVM4	
Direct supply for BA9s 2.4 W max. bulb not included See Table 19.118 BA9s Bulbs and Associated Accessories, page 19-41	< 250 Vac/Vdc	Yellow	ZBVM5
		Blue	ZBVM6
		White	ZBVM1
		Green	ZBVM3

[21] Electrical components with connection by printed circuit board pins are available. Refer to Catalog [9001CT0001](#) for more details.
 [22] Electrical components with connection by plug-in connector are available. Refer to Catalog [9001CT0001](#) for more details.
 [23] For Quick-Connect version add "3" to the end of the catalog number Example: ZBE1013 (Quick-Connect size 1 x 0.250" or 2 x 0.110").
 [24] For Ring Tongue compatible blocks add "9" to the end of the catalog number (Example: ZBE1029).
 [25] Cannot stack additional contact blocks onto these blocks.



ZB4BZ009



ZBE1015



ZB4BZ1015

Table 19.103: Body/Mounting Collar

For use with	Catalog Number
Contact block or light module	ZB4BZ009

Table 19.104: Contact Blocks [26]

Spring Terminal Connections, Contacts for Standard Applications				
Description	Type of contact	N.O.	N.C.	Catalog Number
Contact blocks	Single	1	–	ZBE1015
		–	1	ZBE1025
	Single with body/mounting collar	1	–	ZB4BZ1015
		–	1	ZB4BZ1025
		2	–	ZB4BZ1035
		–	2	ZB4BZ1045
		1	1	ZB4BZ1055
		–	–	
		–	–	
		–	–	

Table 19.105: Light Modules [26]

Spring Terminal Connections				
Description	Supply voltage	Color of light source	Catalog Number	
Integral LED (to combine with heads for integral LED) Protected LED	12 Vac/Vdc	White	ZBVJ15	
		Green	ZBVJ35	
		Red	ZBVJ45	
		Orange	ZBVJ55	
	24 Vac/Vdc	Blue	ZBVJ65	
		White	ZBVB15	
		Green	ZBVB35	
		Red	ZBVB45	
		Orange	ZBVB55	
		Blue	ZBVB65	
		110–120 Vac	White	ZBVG15
			Green	ZBVG35
	Red		ZBVG45	
	Orange		ZBVG55	
	230–240 Vac	Blue	ZBVG65	
		White	ZBVM15	
		Green	ZBVM35	
		Red	ZBVM45	
		Orange	ZBVM55	
		Blue	ZBVM65	

[26] Additional blocks **cannot** be attached to the back of these contact blocks or light modules. However, spring terminal contact blocks can be mounted behind screw terminal contact blocks.

XB4 Legend Holders

Table 19.106: Standard (30 x 40 mm) Legend Holders for 8 x 27 mm Legends

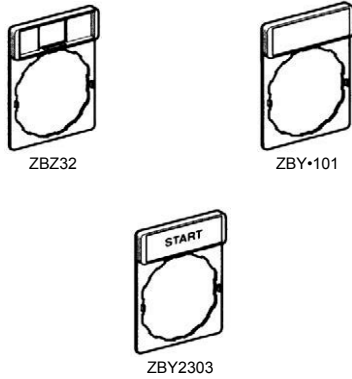

Description	Legend		Catalog Number
	Color	Text	
Without legend [27]	—	—	ZBZ32
With blank legend (for engraving)	Black or red background	—	ZBY2101
	White or yellow background	—	ZBY4101
Custom Legend (Specify Engraving) 2 lines of 11 characters (including spaces) maximum per line	Black background	White	ZBY2002
	Red background	White	ZBY2004
	White background	Black	ZBY4001
	Yellow background	Black	ZBY4005
With legend marked with international language	Black or red background [28]	O (black background)	ZBY2146
		O (red background)	ZBY2931
		I	ZBY2147
		II	ZBY2148
		O-I	ZBY2178
		I-II	ZBY2179
		I-O-II	ZBY2186
		AUTO	ZBY2115
		AUTO-HAND	ZBY2364
		AUTO-O-HAND	ZBY2385
With legend marked with English language	Black or red background [28]	CLOSE	ZBY2314
		DOWN	ZBY2308
		EMERGENCY STOP	ZBY2330
		FAST	ZBY2328
		FORWARD	ZBY2305
		FOR-REV	ZBY2371
		HAND	ZBY2316
		HAND-OFF-AUTO	ZBY2387
		INCH	ZBY2321
		JOG	ZBY2382
		LEFT	ZBY2310
		OFF	ZBY2312
		OFF-ON	ZBY2367
		ON	ZBY2311
		OPEN	ZBY2313
		POWER ON	ZBY2326
		RESET (red background)	ZBY2323
		RESET (black background)	ZBY2322
		REVERSE	ZBY2306
		RIGHT	ZBY2309
		RUN	ZBY2334
		SLOW	ZBY2327
		START	ZBY2303
		STOP	ZBY2304
		STOP-START	ZBY2366
		UP	ZBY2307

Table 19.107: Large (30 x 50 mm) Legend Holders for 18 x 27 mm Legends

Description [29]	Color	Catalog Number
Without legend insert	—	ZBZ33
With blank legend insert	Black or red background	ZBY6101
	White or yellow background	ZBY6102

Table 19.108: 30 x 40 mm legend holder (flush mounting with bezel) for 8 x 27 mm legends

Description [29]	Color	Catalog Number
Without legend	—	ZBZ34
With blank legend	Black or red background	ZBY2H101
	White or yellow background	ZBY4H101

Table 19.109: 30 x 50 mm legend holder (flush mounting with bezel) for 18 x 27 mm legends

Description [29]	Color	Catalog Number
Without legend	—	ZBZ35
With blank legend	Black or red background	ZBY6H101
	White or yellow background	ZBY6H102

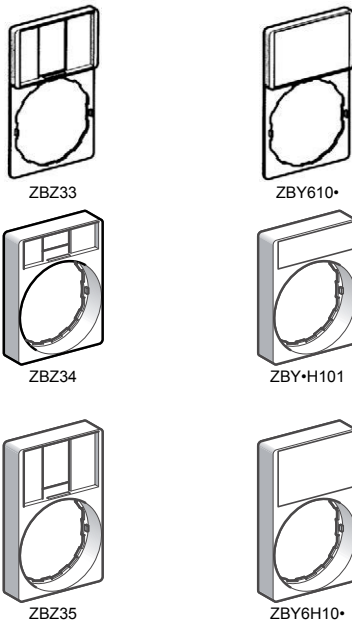

[27] For marked legends, see, Table 19.110 Marked Legends for 30 x 40 mm legend holders, page 19-39.

[28] Start functions: white letters on black background. Stop functions: white letters on red background (unless otherwise specified above).

[29] For custom Legends, see Table 19.111 Legends for Customer Engraving (inserts only), page 19-39 and Table 19.112 Legends for Factory Engraving (inserts only), page 19-39.

XB4 Legend Inserts

Table 19.110: Marked Legends for 8 x 27 mm (for 30 x 40 mm legend holders ZBZ32)



Color	Marking	Text	Catalog Number
Black or red background <i>[30]</i>	International	O (black background)	ZBY02146
		O (red background)	ZBY02931
		I	ZBY02147
		II	ZBY02148
		O-I	ZBY02178
		I-II	ZBY02179
	I-O-II	ZBY02186	
	English	AUTO	ZBY02115
		AUTO-HAND	ZBY02364
		AUTO-O-HAND	ZBY02385
		CLOSE	ZBY02314
		DOWN	ZBY02308
		EMERGENCY STOP	ZBY02330
		FAST	ZBY02328
		FORWARD	ZBY02305
		FOR-REV	ZBY02371
		HAND	ZBY02316
		HAND-OFF-AUTO	ZBY02387
		INCH	ZBY02321
		JOG	ZBY02382
		LEFT	ZBY02310
		OFF	ZBY02312
		OFF-ON	ZBY02367
		ON	ZBY02311
		OPEN	ZBY02313
		POWER ON	ZBY02326
		RESET (red background)	ZBY02323
		RESET (black background)	ZBY02322
		REVERSE	ZBY02306
		RIGHT	ZBY02309
		RUN	ZBY02334
		SLOW	ZBY02327
		START	ZBY02303
STOP		ZBY02304	
STOP-START	ZBY02366		
UP	ZBY02307		

Table 19.111: Legends for Customer Engraving (inserts only)

Description	For use with	Color	Text Color	Catalog Number
8 x 27 mm	30 x 40 mm legend holders	Black or red background	White	ZBY0101
		White or yellow background	Black	ZBY0102
18 x 27 mm	30 x 50 mm legend holders	Black or red background	White	ZBY5101
		White or yellow background	Black	ZBY5102

Table 19.112: Legends for Factory Engraving (inserts only)

Description	For use with	Color	Text Color	Catalog Number
8 x 27 mm Custom Legend/Insert Only (Specify Engraving) 2 lines of 11 characters (including spaces) maximum per line (Example: ZBY01002 marked "Robot")	30 x 40 mm legend holders	Black background	White	ZBY01002
		Red background	White	ZBY01004
		White background	Black	ZBY01001
		Yellow background	Black	ZBY01005
18 x 27 mm Custom Legend/Insert Only (Specify Engraving) 3 lines of 11 characters (including spaces) maximum per line (Example: ZBY05002 marked "Robot")	30 x 50 mm legend holders	Black background	White	ZBY05002
		Red background	White	ZBY05004
		White background	Black	ZBY05001
		Yellow background	Black	ZBY05005

XB4 Legend Sheets

Table 19.113: Sheets of Legends for Push Buttons, Switches, and Pilot Lights

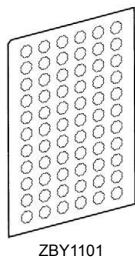

Description	Marking	Text	Catalog Number
Sheets of 66 circular peel-off transparent self-adhesive legends	Blank		ZBY1101
	International	O	ZBY1146
		I	ZBY1147
		II	ZBY1148
		III	ZBY1149
		STOP	ZBY1304
		→	ZBY1912
	English	HAND	ZBY1316
		OFF	ZBY1312
		ON	ZBY1311
		START	ZBY1303
	SIS Label Software	Legend Design Software: English, French, German, Spanish, Italian	

[30] Start functions: white letters on black background. Stop functions: white letters on red background (unless otherwise specified above).

XB4 Accessories

Table 19.114: Push Button Caps—Unmarked



For use with	Type of Push	Color	Catalog Number	
ZB4BA0 push button heads	Flush	White	ZBA1	
		Black	ZBA2	
		Green	ZBA3	
		Red	ZBA4	
		Yellow	ZBA5	
		Blue	ZBA6	
		6 colors [31]	ZBA9	
		Extended	White	ZBL1
			Black	ZBL2
	Green		ZBL3	
	Red		ZBL4	
	Yellow		ZBL5	
	Blue		ZBL6	
	6 colors [31]		ZBL9	

Table 19.115: Push Button Caps—Marked



For use with	Type of Push	Marking		Cap Color	Catalog Number
		Text [32]	Color		
ZB4BA0 push button heads	Flush	I [33]	White	Green	ZBA331
			Black	White	ZBA131
		START [33]	White	Green	ZBA333
			Black	White	ZBA133
		ON	White	Green	ZBA341
			Black	White	ZBA141
		UP [33]	Black	White	ZBA343
		DOWN [33]	White	Black	ZBA344
		⊕ [33]	White	Green	ZBA345
		⊖ [33]	White	Black	ZBA245
		◊	White	Green	ZBA346
		↑	Black	White	ZBA334 [34]
			White	Black	ZBA335 [34]
		O [33]	White	Red	ZBA432
				Black	ZBA232
		STOP [33]	White	Red	ZBA434
				Black	ZBA234
		OFF	White	Red	ZBA435
	Black		ZBA235		
R [34]	White	Blue	ZBA639		

[31] Set of 6 different colored caps: white, black, green, red, yellow, blue.
 [32] Start functions: white letters on black background. Stop functions: white letters on red background (unless otherwise specified).
 [33] Double injection molded marking.
 [34] Cap supplied not clipped-in, allowing orientation of arrow in any one of 4 directions: ↑, ↓, ←, or →



Table 19.116: Multiple-head and XB5R Push Button Caps^[35]

For use with	Type of Push	Marking	Cap Color	Catalog Number
Double push button heads Tripe push button heads ZB4RZA0 ZB5RZA0	Flush	Unmarked	White	ZBA71
		"I" black		ZBA7131
		→ black		ZBA7134
		"+" black		ZBA7138
		Unmarked		ZBA72
		"O" white	Black	ZBA7232
		"+" white		ZBA7233
		⇔ white		ZBA7235
		"I" white		ZBA7237
		Unmarked		ZBA73
		"I" white	Green	ZBA7331
		"+" white		ZBA7333
		† white		ZBA7335
		"I" white		ZBA7336
		Unmarked		ZBA74
		"O" white	Red	ZBA7432
		Unmarked		ZBA75
		Unmarked	Yellow	ZBA76
		Unmarked	Blue	ZBA77
		Assorted	10 colors ^[36]	ZBA79

Table 19.117: Accessories

Description	Application	Color	Catalog Number
Padlocking kit Conforming to EN/ISO 13850 ^[37] (See legends below)	For Emergency Stop function only, with the following Ø 40 trigger-action push buttons: XB4BT8• XB4BS8• XB4BS9• ZB4BT8• ZB4BS8• ZB4BS9•	Yellow	ZBZ3605
Metal guards Padlockable	For Emergency Stop function only with the following Ø 40 mm trigger-action push buttons: XB4BT8• XB4BS8• XB4BS9• ZB4BT8• (except ZB5AT8643M) ZB4BS8• ZB4BS9•	Chrome Plated	ZBZ1600
		Black	ZBZ1602
		Red	ZBZ1604
		Yellow	ZBZ1605
Metal guard, padlockable	For Emergency Stop function with XB4 and XB5 E-Stop 30 mm and 40 mm operators	Chrome Plated	ZBZ1700
Metal guard	For XB4 illuminated push buttons	Chrome Plated	ZBZ1800
Plastic guards ^[38]	Round Guard for ZB4BS5430, 2.5" dia EMO Mushroom Operators	Yellow	ZB4BZ1905
	Narrow Flange Guard for ZB4BS5430 or ZB4BS84430 EMO Mushroom Operators ^[39]	Yellow	ZB4BZ2005
	Trigger Action Guard for ZB4BS84430, 3" dia EMO Mushroom Operators	Yellow	ZB4BZ2105
Padlockable flaps	For push buttons	Black	ZB4BZ62
		Red	ZB4BZ64
Mounting kit	For push buttons ZB4B• with flush mounting bezel head For 30 mm mounting hole. Minimum quantity 10		ZB4BZ011
Metal blanking plug, round chrome plated ^[40]	For Ø 22 mm control and signalling units		ZB4SZ3
Plastic blanking plug, round black with mounting nut	For Ø 22 mm control and signalling units		ZB5SZ3
Description	Marking	Color	Catalog Number
Ø 60 mm Legend for padlocking device ZBZ3605	Without	Yellow	ZBY9101T
	EMERGENCY STOP	Yellow	ZBY9330T

Table 19.118: BA9s Bulbs and Associated Accessories

Description	Characteristics	Catalog Number
Replacement bulbs (Type BA9s) Incandescent	6 V, 1.2 W	DL1CB006
	12 V, 2 W	DL1CE012
	24 V, 2 W	DL1CE024
Neon bulbs	120–130 V, 2.4 W	DL1CF130
	120–130 V, 1.8 mA	DL1CF110
Bulb extractor	230–240 V, 1.8 mA	DL1CF220
Lens cap tightening tool	—	XBFX13
Power driver bits for mounting and wiring (package of 5)	Illuminated push buttons with flush push	ZBZ8
Mounting Adapter	Cross headed screw (POZIDRIV type 1)	ZB4BZ905
	For mounting 22 mm push button in 30 mm KO	ZBZ41

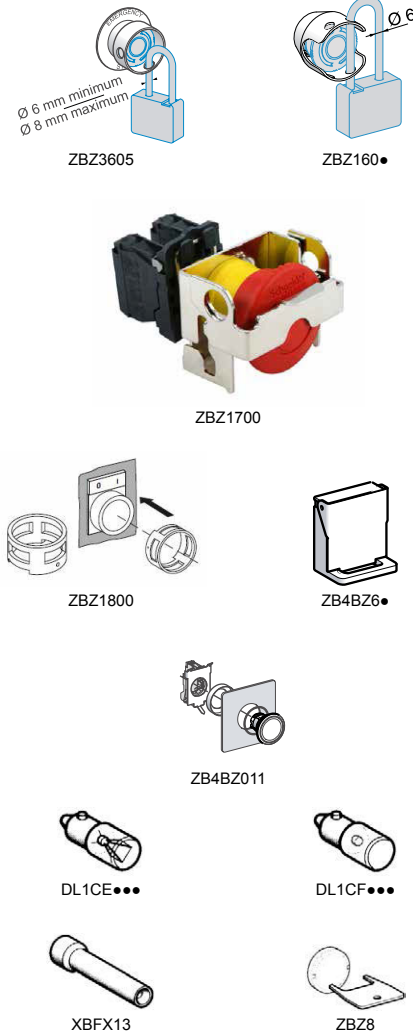

^[35] Sold in lots of 10.
^[36] Set of 10 different caps: white, black, green, red, yellow, blue, white "I" on green background, black "I" on white background, white "O" on red background, white "O" on black background.
^[37] Standard circular legends are not compatible with this product. Use special legends ZBY••T listed above.
^[38] For additional information, refer to publication 9001DB0601R6/06.
^[39] Maximum panel thickness is 2.5 mm.
^[40] Requires a ZB4BZ009 body/mounting collar for mounting, see [XB4 Electrical Components](#), page 19-35.

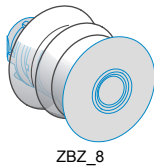

Table 19.119: Bellows Seals for Harsh Environments (IP 69K) [41]

Description	For use with	Color & Material	Sold in Lots of	Catalog Number
Bellows seals for harsh environments (Humidity, dust, high-pressure cleaning)	Any Harmony XB4 metal, mushroom head push button Ø 40 mm or Ø 60 mm (except ZB4BR*16)	Red Silicone	2	ZBZ48
		Black EPDM	2	ZBZ28
		Yellow EPDM	2	ZBZ58



Table 19.120: Boot for Standard Selector Switch Handle

Description	For use with	Catalog Number
Boot for standard handle	ZB4BD**	ZBD D2



Table 19.121: Replacement Keys

Description	Key Number	Catalog Number
Set of 2 keys	455	ZBG455
	421E	ZBG421E
	458A	ZBG458A
	520E	ZBG520E
	3131A	ZBG3131A
Set of 2 keys, One of which is supplied booted (rubber boot)	455	ZBG455P
	421E	ZBG421EP
	458A	ZBG458AP
	520E	ZBG520EP
	3131A	ZBG3131AP

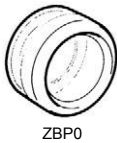

Table 19.122: Clear Boots

Description	For use with	Material	Catalog Number
Single boots	Booted push buttons with circular head	Silicone	ZBPA
	Booted push buttons with circular head used in food industry applications		ZBPOA
Double boots	Double-headed push buttons, two flush		ZBA708
	Double-headed push buttons, one flush + one projecting		ZBA710
Triple boot	Triple-headed push buttons, two flush + one projecting	ZBA709	



Table 19.123: Colored boots

Description	Color	Catalog Number
Single boot (can be replaced without dismantling the head)	Black	ZB2 BP012
	Green	ZB2 BP013
	Red	ZB2 BP014
	Yellow	ZB2 BP015
	Blue	ZB2 BP016

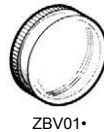

Table 19.124: Lens Caps

For use with	Color	Catalog Number
Lens caps for Protected LED™ light modules		
Pilot lights	White	ZBV0113
	Green	ZBV0133
	Red	ZBV0143
	Yellow	ZBV0153
	Blue	ZBV0163
Illuminated push buttons with flush push	White	ZBW9113
	Green	ZBW9133
	Red	ZBW9143
	Yellow	ZBW9153
	Blue	ZBW9163
Illuminated push buttons with extended push	White	ZBW9313
	Green	ZBW9333
	Red	ZBW9343
	Yellow	ZBW9353
	Blue	ZBW9363
Lens caps for BA9 light modules		
Pilot lights	White	ZBV011
	Green	ZBV013
	Red	ZBV014
	Yellow	ZBV015
	Blue	ZBV016
Illuminated push buttons with flush push	White	ZBW917
	Green	ZBW913
	Red	ZBW914
	Yellow	ZBW915
	Blue	ZBW916
Illuminated push buttons with extended push	White	ZBW937
	Green	ZBW933
	Red	ZBW934
	Yellow	ZBW935
	Blue	ZBW936
Clear	ZBW937	

[41] Only when mounted on control stations. Use special legends ZBY*•T.

XB5 Complete Devices

Table 19.125: Non-Illuminated Push Buttons, Momentary (screw clamp terminal connections)



Shape of Head	Type of Push	Type of Contact		Marking	Cap Color	Catalog Number	Components	
		N.O.	N.C.					
	Flush	1	—	—	Black	XB5AA21	(ZB5AZ101 + ZB5AA2)	
					Green	XB5AA31	(ZB5AZ101 + ZB5AA3)	
					Yellow	XB5AA51	(ZB5AZ101 + ZB5AA5)	
					Blue	XB5AA61	(ZB5AZ101 + ZB5AA6)	
		—	1	1	—	Red	XB5AA42	(ZB5AZ102 + ZB5AA4)
						Black	XB5AA25	(ZB5AZ105 + ZB5AA2)
						Green	XB5AA35	(ZB5AZ105 + ZB5AA3)
						Red	XB5AA45	(ZB5AZ105 + ZB5AA4)
						Yellow	XB5AA55	(ZB5AZ105 + ZB5AA5)
						Blue	XB5AA65	(ZB5AZ105 + ZB5AA6)
	Flush	1	—	"I" (white)	Green	XB5AA3311	(ZB5AZ101 + ZB5AA331)	
	Flush	—	1	"O" (white)	Red	XB5AA4322	(ZB5AZ102 + ZB5AA432)	
	Flush with clear silicone boot (color of pusher unobscured)	1	—	—	Black	XB5AP21	(ZB5AZ101 + ZB5AP2)	
					Green	XB5AP31	(ZB5AZ101 + ZB5AP3)	
					Yellow	XB5AP51	(ZB5AZ101 + ZB5AP5)	
					Blue	XB5AP61	(ZB5AZ101 + ZB5AP6)	
	Extended	—	1	—	Red	XB5AL42	(ZB5AZ102 + ZB5AL4)	
		1	1	—	Red	XB5AL45	(ZB5AZ105 + ZB5AL4)	
	Mushroom head Ø 40 mm	1	—	—	Black	XB5AC21	(ZB5AZ101 + ZB5AC2)	

Table 19.126: Two Button Push Buttons, Momentary (screw clamp terminal connections)



Shape of Head	Type of Push	Type of Contact		Marking	Degree of Protection	Catalog Number	Components
		N.O.	N.C.				
	One flush green push* One extended red push**	1	1	**"I" (white) ***"O" (white)	IP66 IP69K	XB5AL73415	(ZB5AZ105 + ZB5AL7341)

Table 19.127: Two Button Push Buttons, Momentary + one white central pilot light (screw clamp terminal connections)



Shape of Head	Type of Push	Type of Contact		Marking	Degree of Protection	Pilot Light Voltage	Catalog Number
		N.O.	N.C.				
	One flush green push* One extended red push** One white central pilot light block	1	1	**"I" (white) ***"O" (white)	IP66 IP69K	24 120	XB5AW73731B5 XB5AW73731G5
						240	XB5AW73731M5

Table 19.128: Three Button Push Buttons, Momentary (screw clamp terminal connections)



Shape of Head	Type of Push	Type of Contact		Degree of Protection	Marking and Cap Color	Catalog Number
		N.O.	N.C.			
	Two flush pushes + one central projecting red push*	2	1	IP66 IP69K	White "I" on green background White "II" on green background *White "Stop" on red background	XB5AA731327
					Black "→" on white background White "←" on black background *White "Stop" on red background	XB5AA711237

For Legends, see [XB5 Legend Holders](#), page 19-58 and [XB5 Legend Inserts](#), page 19-59.
Caps, see [XB5 Accessories](#), page 19-60.

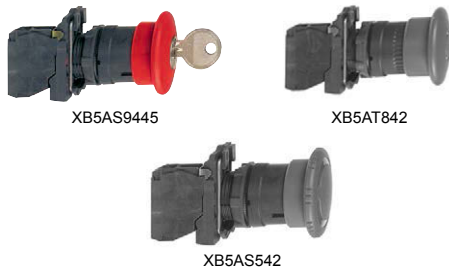

Table 19.129: Non-Illuminated Trigger Action Emergency Stop Push Buttons, Ø 40 mm (Red) (screw clamp terminal connections)

Shape of Head	Type of Push	Type of Contact		Catalog Number	Components
		N.O.	N.C.		
	Trigger action push-pull [42]	1	1	XB5AT845	(ZB5AZ105 + ZB5AT84)
	Trigger action turn-to-release [42]	1	1	XB5AS8445	(ZB5AZ105 + ZB5AS844)
		—	2	XB5AS8444	(ZB5AZ104 + ZB5AS844)
	Trigger action Key release (No. 455) [42]	1	1	XB5AS9445	(ZB5AZ105+ ZB5AS944)
	Trigger action Push-pull [42]	—	1	XB5AT842	(ZB5AZ102 + ZB5AT84)
	Trigger action Turn-to-release [42]	—	1	XB5A8442	(ZB5AZ102 + ZB5AS844)
	Trigger action Key release (No. 455) [42]	—	1	XB5AS9442	(ZB5AZ102 + ZB5AS944)

Table 19.130: Non-Illuminated Selector Switches and Key Switches (screw clamp terminal connections) [43]



Shape of Head	Type of Operator	Type of Contact		Number and Type of Positions	Catalog Number	Components
		N.O.	N.C.			
	Standard lever, black	1	—	2-maintained	XB5AD21	(ZB5AZ101 + ZB5AD2)
		1	1	2-maintained	XB5AD25	(ZB5AZ105 + ZB5AD2)
		2	—	3-maintained	XB5AD33	(ZB5AZ103 + ZB5AD3)
3-momentary to center	XB5AD53			(ZB5AZ103 + ZB5AD5)		
	Extended lever, black	1	—	2-maintained	XB5AJ21	(ZB5AZ101 + ZB5AJ2)
		2	—	3-maintained	XB5AJ33	(ZB5AZ103 + ZB5AJ3)
				3-momentary to center	XB5AJ53	(ZB5AZ103 + ZB5AJ5)
	Key (No. 455)	1	—	2-maintained	XB5AG21	(ZB5AZ101 + ZB5AG2)
				2-momentary to left	XB5AG61	(ZB5AZ101 + ZB5AG6)
		2	—	3-maintained	XB5AG03	(ZB5AZ103 + ZB5AG0)
					XB5AG33	(ZB5AZ103 + ZB5AG3)
				3-maintained		

NOTE: The symbol indicates key withdrawal position(s).

For Legends, see [XB5 Legend Holders, page 19-58](#) and [XB5 Legend Inserts Only, page 19-59](#)

[42] Trigger action mushroom heads are tamper proof in that a change of contact state is not possible by teasing or floating the operator. For emergency stop applications, always use a trigger action push button (per EN/IEC 13850).

[43] For contact configurations, see [Table 19.144 Sequence of Contacts on Selector Switch Bodies](#), page 19-50.



XB5AVB1

Table 19.131: Pilot Lights with Protected LED™ (screw clamp terminal connections) [44]

Shape of Head	Supply Voltage	Color	Catalog Number	Components
	24 Vac/Vdc	White	XB5AVB1	(ZB5AVB1 + ZB5AV013)
		Green	XB5AVB3	(ZB5AVB3 + ZB5AV033)
		Red	XB5AVB4	(ZB5AVB4 + ZB5AV043)
		Yellow	XB5AVB5	(ZB5AVB5 + ZB5AV053)
		Blue	XB5AVB6	(ZB5AVB6 + ZB5AV063)
	110–120 Vac	White	XB5AVG1	(ZB5AVG1 + ZB5AV013)
		Green	XB5AVG3	(ZB5AVG3 + ZB5AV033)
		Red	XB5AVG4	(ZB5AVG4 + ZB5AV043)
		Yellow	XB5AVG5	(ZB5AVG5 + ZB5AV053)
		Blue	XB5AVG6	(ZB5AVG6 + ZB5AV063)



XB5AV63

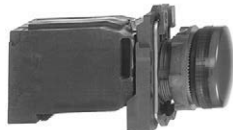

XB5AV34

Table 19.132: Pilot Lights for BA9s Bulb (screw clamp terminal connections)

Shape of Head	Supply Voltage	Color	Catalog Number	Components
Direct supply, for BA9s (incandescent, LED, neon) V < 250 V, 2.4 W bulb (bulb not included) [45]				
	< 250 Vac/Vdc	White	XB5AV61	(ZB5AV6 + ZB5AV01)
		Green	XB5AV63	(ZB5AV6 + ZB5AV03)
		Red	XB5AV64	(ZB5AV6 + ZB5AV04)
		Yellow	XB5AV65	(ZB5AV6 + ZB5AV05)
Transformer type with 1.2 VA, 6 V secondary. BA9s incandescent bulb included				
	110–120 Vac 50/60 Hz	White	XB5AV31	(ZB5AV3 + ZB5AV01)
		Green	XB5AV33	(ZB5AV3 + ZB5AV03)
		Red	XB5AV34	(ZB5AV3 + ZB5AV04)
		Yellow	XB5AV35	(ZB5AV3 + ZB5AV05)

Table 19.133: Illuminated Push Buttons, Momentary (screw clamp terminal connections) [44]

Shape of Head	Description	Type of Contact		Supply Voltage	Color of Push	Catalog Number	Components
		N.O.	N.C.				
Flush							
	Direct supply for BA9s 2.4 W max. bulb not included	1	1	24 Vac/Vdc	White	XB5AW31B5	(ZB5AW0B15 + ZB5AW313)
					Green	XB5AW33B5	(ZB5AW0B35 + ZB5AW333)
					Red	XB5AW34B5	(ZB5AW0B45 + ZB5AW343)
					Yellow	XB5AW35B5	(ZB5AW0B55 + ZB5AW353)
					Blue	XB5AW36B5	(ZB5AW0B65 + ZB5AW363)
				110–120 Vac	White	XB5AW31G5	(ZB5AW0G15 + ZB5AW313)
					Green	XB5AW33G5	(ZB5AW0G35 + ZB5AW333)
					Red	XB5AW34G5	(ZB5AW0G45 + ZB5AW343)
					Yellow	XB5AW35G5	(ZB5AW0G55 + ZB5AW353)
					Blue	XB5AW36G5	(ZB5AW0G65 + ZB5AW363)
	Transformer type 1.2 VA, 6 V secondary. BA9s incandescent bulb included	1	1	110–120 Vac 50/60 Hz	White	XB5AW3165	(ZB5AW065 + ZB5AW31)
					Green	XB5AW3365	(ZB5AW065 + ZB5AW33)
					Red	XB5AW3465	(ZB5AW065 + ZB5AW34)
					Yellow	XB5AW3565	(ZB5AW065 + ZB5AW35)
	Transformer type 1.2 VA, 6 V secondary. BA9s incandescent bulb included	1	1	230–240 Vac 50/60 Hz	White	XB5AW3135	(ZB5AW035 + ZB5AW31)
					Green	XB5AW3335	(ZB5AW035 + ZB5AW33)
					Red	XB5AW3435	(ZB5AW035 + ZB5AW34)
					Yellow	XB5AW3535	(ZB5AW035 + ZB5AW35)
	Transformer type 1.2 VA, 6 V secondary. BA9s incandescent bulb included	1	1	230–240 Vac 50/60 Hz	White	XB5AW3145	(ZB5AW045 + ZB5AW31)
					Green	XB5AW3345	(ZB5AW045 + ZB5AW33)
					Red	XB5AW3445	(ZB5AW045 + ZB5AW34)
					Yellow	XB5AW3545	(ZB5AW045 + ZB5AW35)
Extended							
	Direct supply for BA9s 2.4 W max. bulb not included	1	1	24 Vac/Vdc	White	XB5AW11B5	(ZB5AW0B15 + ZB5AW113)
					Green	XB5AW13B5	(ZB5AW0B35 + ZB5AW133)
					Red	XB5AW14B5	(ZB5AW0B45 + ZB5AW143)
					Yellow	XB5AW15B5	(ZB5AW0B55 + ZB5AW153)
					Blue	XB5AW16B5	(ZB5AW0B65 + ZB5AW163)
				110–120 Vac	White	XB5AW11G5	(ZB5AW0G15 + ZB5AW113)
					Green	XB5AW13G5	(ZB5AW0G35 + ZB5AW133)
					Red	XB5AW14G5	(ZB5AW0G45 + ZB5AW143)
					Yellow	XB5AW15G5	(ZB5AW0G55 + ZB5AW153)
					Blue	XB5AW16G5	(ZB5AW0G65 + ZB5AW163)

For legends, see XB5 Legend Holders, page 19-58 and XB5 Legend Inserts Only, page 19-59.

[44] For 240V LED, replace the "B" or "G" with "M". (Example: XB5APVB1 (24 V) to XB5APVM1 (240 Vac only))

[45] For bulb information, refer to Table 19.183 BA9s Bulbs and Associated Accessories, page 19-61

XB5 Non-Illuminated Operators

Table 19.134: Non-Illuminated Operators, Momentary—Unmarked



Shape of Head	Type of Push	Cap Color	Catalog Number
	Flush, without color cap [46]	—	ZB5AA0
	Flush, with set of 6 color caps	6 colors [47]	ZB5AA9
	Flush	White	ZB5AA1
		Black	ZB5AA2
		Green	ZB5AA3
		Red	ZB5AA4
		Yellow	ZB5AA5
		Blue	ZB5AA6
	Flush with transparent cap, for insertion of legend [48]	Gray	ZB5AA8
		White	ZB5AA18
		Green	ZB5AA38
		Red	ZB5AA48
		Yellow	ZB5AA58
		Blue	ZB5AA68
	Extended	White	ZB5AL1
		Black	ZB5AL2
		Green	ZB5AL3
		Red	ZB5AL4
		Yellow	ZB5AL5
		Blue	ZB5AL6
	Booted Flush (clear) Cap color unobscured	White	ZB5APA1
		Black	ZB5APA2
		Green	ZB5APA3
		Red	ZB5APA4
		Yellow	ZB5APA5
		Blue	ZB5APA6
	Booted Extended (clear) Cap color unobscured	White	ZB5AP1
		Black	ZB5AP2
		Green	ZB5AP3
		Red	ZB5AP4
		Yellow	ZB5AP5
		Blue	ZB5AP6
	Booted (colored) Cap color unobscured	White	ZB5AP1S
		Black	ZB5AP2S
		Green	ZB5AP3S
		Red	ZB5AP4S
		Yellow	ZB5AP5S
		Blue	ZB5AP6S
	Booted (clear) for insertion of legend [48] Cap color unobscured	White	ZB5AP18
		Green	ZB5AP38
		Red	ZB5AP48
		Yellow	ZB5AP58
		Blue	ZB5AP68
		White	ZB5AA14
	Flush Plunger (with high guard)	Black	ZB5AA24
		Green	ZB5AA34
		Red	ZB5AA44
		Yellow	ZB5AA54
		Blue	ZB5AA64
		White	ZB5CA1
	Flush	Black	ZB5CA2
		Green	ZB5CA3
		Red	ZB5CA4
		Yellow	ZB5CA5
		Blue	ZB5CA6
		White	ZB5CL1
	Extended	Black	ZB5CL2
		Green	ZB5CL3
		Red	ZB5CL4
		Yellow	ZB5CL5
		Blue	ZB5CL6
		White	ZB5AA16
	Heads only Recessed (high guard)	Black	ZB5AA26
		Green	ZB5AA36
		Red	ZB5AA46
		Yellow	ZB5AA56
		Blue	ZB5AA66
		White	ZB5CA16
	Heads only Recessed (high guard)	Black	ZB5CA26
		Green	ZB5CA36
		Red	ZB5CA46
		Yellow	ZB5CA56
		Blue	ZB5CA66

For Legends, see XB5 Legend Holders, page 19-58 and XB5 Legend Inserts Only, page 19-59

[46] Order color cap separately, see XB5 Accessories , page 19-60.
 [47] Six colored caps included with head (white, black, green, red, yellow, blue).
 [48] For legend ordering information see XB5 Accessories, page 19-60.



Table 19.135: Non-Illuminated Operators, Momentary—Premarked

Shape of Head	Type of Push	Marking		Cap Color	Catalog Number
		Text	Color		
	Flush	I	White	Green	ZB5AA331
			Black	White	ZB5AA131
		START	White	Green	ZB5AA333
			Black	White	ZB5AA133
		ON	White	Green	ZB5AA341
			Black	White	ZB5AA141
		T	White	Green	ZB5AA345
		O	White	Red	ZB5AA432
				Black	ZB5AA232
		STOP	White	Red	ZB5AA434
				Black	ZB5AA234
		OFF	White	Red	ZB5AA435
UP	Black	White	ZB5AA235		
DOWN	White	Black	ZB5AA344		
		White	ZB5AA334		
↑ [49]	White	Black	ZB5AA335		
		White	ZB5AA432		
	Extended	O	White	Red	ZB5AL432
			Black	ZB5AL232	
		STOP	White	Red	ZB5AL434
OFF	White	Black	ZB5AL234		
		Red	ZB5AL435		
	Flush	I	White	Green	ZB5CA331
			White	Red	ZB5CA432

Table 19.136: Mushroom Heads, Momentary

Shape of Head	Diameter of Head	Color of Head	Catalog Number
	30 mm	Black	ZB5AC24
		Green	ZB5AC34
		Red	ZB5AC44
		Yellow	ZB5AC54
		Blue	ZB5AC64
		Black	ZB5AC2
	40 mm	Green	ZB5AC3
		Red	ZB5AC4
		Yellow	ZB5AC5
		Blue	ZB5AC6
		Black	ZB5AR2
		Green	ZB5AR3
	60 mm	Red	ZB5AR4
		Yellow	ZB5AR5
		Blue	ZB5AR6

For legends, see XB5 Legend Holders, page 19-58 and XB5 Legend Inserts Only, page 19-59



[49] Cap supplied not clipped-in, allowing orientation of arrow in any one of 4 directions:



ZB5AH04

Table 19.137: Non-Illuminated Push-on/Push-off Operators

Shape of Head	Type of Push	Color of Push	Catalog Number
	Flush	White	ZB5AH01
		Black	ZB5AH02
		Green	ZB5AH03
		Red	ZB5AH04
		Yellow	ZB5AH05
		Blue	ZB5AH06
	Extended	White	ZB5AH1
		Black	ZB5AH2
		Green	ZB5AH3
		Red	ZB5AH4
		Yellow	ZB5AH5
		Blue	ZB5AH6
	Flush	White	ZB5CH01
		Black	ZB5CH02
		Green	ZB5CH03
		Red	ZB5CH04
		Yellow	ZB5CH05
		Blue	ZB5CH06

Table 19.138: Two Head Operators, Momentary

Shape of Head	Description	Marking	Cap Color	Degree of Protection	Catalog Number
No Marking					
	Two flush	—	Green Red	IP66 IP69K	ZB5AA7340
		—	White Black		ZB5AA7120
	One flush One extended	—	Green Red	IP66 IP69K	ZB5AL7340
Premarked					
	Two flush	"I" (white) "O" (white)	Green Red	IP66 IP69K	ZB5AA7341
		"I" (black) "O" (white)	White Black		ZB5AA7121
	One flush One extended	"I" (white) "O" (white)	Green Red	IP66 IP69K	ZB5AL7341
Without caps					
	Two flush without caps	—	—	IP66 IP69K	ZB5AA79

Table 19.139: Three Head Operators, Momentary

Shape of Head	Description	Marking	Cap Color	Degree of Protection	Catalog Number
Premarked					
	Two flush + one central projecting red push marked "Stop"	"I" (white) "II" (white)	Green Green	IP66 IP69K	ZB5AA73132
		"←" (white) "→" (white)	Green Green		ZB5AA73133
		"↑" (white) "↓" (white)	Green Green		ZB5AA73134
		"+" (white) "-" (white)	Green Green		ZB5AA73135
		"+" (black) "-" (black)	White White		ZB5AA71115
		"←" (black) "→" (white)	White Black		ZB5AA71123
		"↑" (black) "↓" (white)	White Black		ZB5AA71124
		"I" (white) "I" (white)	Black Black		ZB5AA72124
Without caps					
	Two flush without caps	—	—	IP66 IP69K	ZB5AA791

For caps, see [XB5 Accessories](#), page 19-60



ZB5AL7341



ZB5AA7121



ZB5AA73133



ZB5AA71124

XB5 Emergency Stop Operators

Table 19.140: Mushroom Heads for Maintained Push Buttons



Shape of Head	Type of Push	Diameter of Head	Color	Catalog Number
For use in Emergency Stop applications				
	Trigger action Push-pull [50]	30 mm	Red	ZB5AT844
		40 mm	Red	ZB5AT84
		60 mm	Red	ZB5AX84
	Trigger action Turn-to-release [50]	30 mm	Red	ZB5AS834
		40 mm	Red	ZB5AS844
		60 mm	Red	ZB5AS864
	Trigger action Key release (No. 455) [50]	30 mm	Red	ZB5AS934
		40 mm	Red	ZB5AS944 [51]
		60 mm	Red	ZB5AS964
For use in non-Emergency Stop applications				
	Push-pull	30 mm	Black	ZB5AT24
		40 mm	Black	ZB5AT2
		60 mm	Black	ZB5AX2
	Turn-to-release	30 mm	Black	ZB5AS42
		40 mm	Black	ZB5AS52
		60 mm	Yellow	ZB5AS55
	Key release (No. 455)	30 mm	Black	ZB5AS62
		40 mm	Black	ZB5AS72
		60 mm	Black	ZB5AS12
	Key release (No. 455)	30 mm	Black	ZB5AS22
		40 mm	Black	ZB5AS12
		60 mm	Black	ZB5AS22

Table 19.141: Circular Legends for Emergency Stop Mushroom Heads (yellow background)

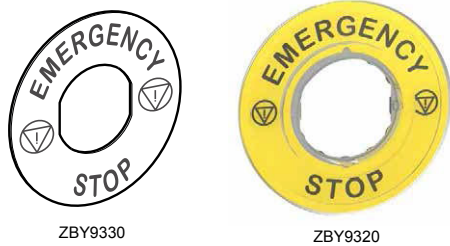

Diameter	Text	Catalog Number
60 mm	Blank	ZBY9101
	EMERGENCY STOP	ZBY9330
90 mm	Blank	ZBY8101
	EMERGENCY STOP	ZBY8330
60 mm Bezeled	Blank	ZBY9121
	Emergency Stop	ZBY9320
	Prada de Emergencia	ZBY9420
	Not Halt	ZBY9220

For Legends, see [XB5 Legend Holders, page 19-58](#) and [XB5 Legend Inserts, page 19-59](#)

[50] Trigger action mushroom heads are tamper proof in that a change of contact state is not possible by teasing or floating the operator. For emergency stop applications, always use a trigger action push button (per EN/IEC 13850).

[51] Other key numbers:

- key no. 421E: add the suffix 12 to the catalog number.
- key no. 458A: add the suffix 10 to the catalog number.
- key no. 520E: add the suffix 14 to the catalog number.
- key no. 3131A: add the suffix 20 to the catalog number.

Example: The catalog number for a Ø 40 mm red mushroom head for a trigger action, maintained push button, with release by key no. 421E becomes: ZB5AS94412.

XB5 Selector Switches

Table 19.142: Non-Illuminated Selector Switches

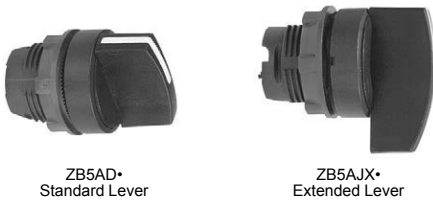

Color	Number and Type of Positions	Diagram	Standard Lever [52]	Extended Lever [52]
			Catalog Number	
Black	2-maintained		ZB5AD2	ZB5AJ2
Black	2-momentary from right to left		ZB5AD4	ZB5AJ4
Black	3-maintained		ZB5AD3	ZB5AJ3
Black	3-momentary to center		ZB5AD5	ZB5AJ5
Black	3-momentary from left to center		ZB5AD7	ZB5AJ7
Black	3-momentary from right to center		ZB5AD8	ZB5AJ8

Table 19.143: Non-Illuminated Key Switches



Type of Operator	Number and Type of Positions	Diagram	Catalog Number [53]
2-maintained			ZB5AG2
			ZB5AG4
			ZB5AG02
2-momentary from right to left			ZB5AG6
			ZB5AG0
3-maintained			ZB5AG3
			ZB5AG5
			ZB5AG9
			ZB5AG09
			ZB5AG1
3-momentary from left to center			ZB5AG7
3-momentary to center			ZB5AG8
3-momentary from right to center			ZB5AG08
			ZB5AG05

Key (No. 455) [53]



NOTE: The symbol indicates key withdrawal position(s).

Table 19.144: Sequence of Contacts on Selector Switch Bodies

Unit Type	Selector Switches															
	2-position						3-position									
	315°		45°		315°		0°		45°							
Note: L=Left, C=Center, R=Right, O=Open, X=Closed																
Operator Plunger Position	Up															
	Down															
Contact Block Location	L	C	R	L	C	R	L	C	R	L	C	R	L	C	R	
Contacts	N.O.	O	O	O	X	X	X	X	X	O	O	O	O	X	X	X
	N.C.	X	X	X	O	O	O	O	O	X	X	X	X	X	O	O

For Selector Switch Sequence, see [Table 19.96 Sequence of Contacts on Illuminated Selector Switch Bodies](#), page 19-34

[52] For colored lever, add the following code to the end of catalog number: 01—white, 03—green, 04—red, 05—yellow, 06—blue (Example: ZB5AD204).

[53] Other key numbers:

- key no. 421E: add the suffix 12 to the catalog number.
- key no. 458A: add the suffix 10 to the catalog number.
- key no. 520E: add the suffix 14 to the catalog number.
- key no. 3131A: add the suffix 20 to the catalog number.
- key no. 8D1: add the suffix D to the catalog number.

Example: The catalog number for a head with key no. 421E for a 2 position maintained, lockable selector switch, with key withdrawal from the left-hand position, becomes: ZB5AG212

XB5 Specialty Operators

Table 19.145: Reset Operators



XB5AA

Shape of Head	Actuation Distance		Text	Color	Catalog Number
	in	mm			
Flush	Adjustable Shaft [54]				
	0.67–4.72	17–120	Without	Green	XB5AA831
				Red	XB5AA841
				Blue	XB5AA861
			O	XB5AA84101	
			R	XB5AA86102	
			Blue	XB5AA86102	
	4.72–10.12	120–257	Without	Green	XB5AA832
				Red	XB5AA842
				Blue	XB5AA862
			O	XB5AA84201	
			R	XB5AA86201	
Blue			XB5AA86202		
Extended					
Extended	0.67–4.72	17–120	O	Red	XB5AL84101
	4.72–10.12	120–257	O	Red	XB5AL84201

Table 19.146: Potentiometer Operator (with Mounting Collar)



XD5PA12

Shape of Head	Description	Application	Catalog Number
Potentiometer Operator	For potentiometer with shaft length 1.73 to 1.97 in. (44 to 50 mm) (potentiometer not included)	For shaft Ø 0.25 in. (6.35 mm)	ZB5AD922
		For shaft Ø 0.24 in. (6 mm)	ZB5AD912

Table 19.147: Joystick (54 mm, Extended Operating Shaft) [55]

Description	Contact Operation	Action	Catalog Number
2 direction	1 step 1 N.O. contact per direction	Maintained	XD5PA12
		Momentary	XD5PA22
4 direction	1 step 1 N.O. contact per direction	Maintained	XD5PA14
		Momentary	XD5PA24

Table 19.148: Legends for Joystick

Description	For use with	Color	Catalog Number
Legends 30 x 48 mm for engraving	2 direction	Black one side Red reverse	ZBG2201
		White one side Yellow reverse	ZBG2401
Legends 48 x 48 mm for engraving	4 direction	Black one side Red reverse	ZBG4201
		White one side Yellow reverse	ZBG4401

Table 19.149: Hour Counters [56]



XB5DS•

Characteristics	Supply Voltage	Catalog Number
Indication 0–9999.9 (IP40 NEMA 1)	12–24 Vdc or Vac, 50/60 Hz	XB5DSB
	120 Vac, 60 Hz	XB5DSG
	230–240 Vac, 50 Hz	XB5DSM

Table 19.150: Buzzer [56]



XB5KS•

Characteristics	Supply Voltage	Catalog Number
85 db buzzer:4kHz, continuous or intermittent (IP40 NEMA 1)	24 Vdc or Vac, 50/60 Hz	XB5KSB
	120 Vac, 60 Hz	XB5KSG
	230–240 Vac, 50 Hz	XB5KSM

Table 19.151: Two Position Toggle Switch



ZB5AD28

Shape of Head	Color	Type of Positions	Catalog Number
Toggle Switch	Black	Maintained	ZB5AD28
	Black	Momentary	ZB5AD48

For legends, see XB5 Legend Holders, page 19-58, XB5 Legend Inserts, page 19-59, and Table 19.178 Sheets of Legends for Push Buttons, Switches, and Pilot Lights, page 19-60.

[54] Shaft only (short) is W40437632
[55] Do not use standard contact blocks ZBE10• (single) or ZBE20• (double)
[56] UR E191025, XHNR2 and XHNR8.

XB5 Pilot Lights

Table 19.152: Pilot Light Heads



Shape of Head	For use with Body Comprising Light Module Type	Color of Lens	Catalog Number
	Protected LED™ only	White Green Red Yellow Blue	ZB5AV013 ZB5AV033 ZB5AV043 ZB5AV053 ZB5AV063
	Protected LED only Fresnel (jeweled) lens [57]	White Green Red Amber Blue	ZB5AV013S ZB5AV033S ZB5AV043S ZB5AV053S ZB5AV063S
	For BA9s incandescent bulb, neon or LED only [58]	White Green Red Yellow Blue Clear	ZB5AV01 ZB5AV03 ZB5AV04 ZB5AV05 ZB5AV06 ZB5AV07
	For BA9s incandescent bulb, neon or LED Fresnel (jeweled) lens [58]	White Green Red Amber Blue Clear	ZB5AV01S ZB5AV03S ZB5AV04S ZB5AV05S ZB5AV06S ZB5AV07S
	Protected LED only	White Green Red Yellow Blue	ZB5CV013 ZB5CV033 ZB5CV043 ZB5CV053 ZB5CV063

For legends, refer to XB5 Legend Holders, page 19-58, XB5 Legend Inserts, page 19-59, and Table 19.178 Sheets of Legends for Push Buttons, Switches, and Pilot Lights, page 19-60

Table 19.153: Complete Bodies (Mounting Collar + Light Module for BA9s Incandescent Bulb, Neon or LED)



Description	Light Source	Supply Voltage (V)	Catalog Number
Screw clamp terminal connections			
Direct supply	BA9s bulb 2.4 W max. Not included [58]	<250	ZB5AV6
Direct supply	BA9s incandescent, bulb included	24 V 2 W	ZB5AV624
Direct supply	BA9s incandescent, bulb included	120 V 2.4 W	ZB5AV6120
Transformer type 1.2 VA, 6 V secondary	BA9s incandescent bulb included	110–120 Vac, 50/60 Hz	ZB5AV3
		230–240 Vac, 50/60 Hz	ZB5AV4
		400–50 Hz	ZB5AV5
		440–480 Vac, 60 Hz	ZB5AV8
		550–600 Vac, 60 Hz	ZB5AV9

Table 19.154: Complete Bodies (Mounting Collar + Protected LED™ Light Module) [59][60]



Light Source	Supply Voltage	Color of Light Source	Catalog Number	
Screw clamp terminal connections				
	12 Vac/Vdc	White	ZB5AVJ1	
		Green	ZB5AVJ3	
		Red	ZB5AVJ4	
		Yellow	ZB5AVJ5	
		Blue	ZB5AVJ6	
		White	ZB5AVB1	
	24 Vac/Vdc	Green	ZB5AVB3	
		Red	ZB5AVB4	
		Yellow	ZB5AVB5	
		Blue	ZB5AVB6	
		24–120 Vac/Vdc	White	ZB5AVBG1
			Green	ZB5AVBG3
Red	ZB5AVBG4			
Yellow	ZB5AVBG5			
Blue	ZB5AVBG6			
110–120 Vac	White		ZB5AVG1	
	Green	ZB5AVG3		
	Red	ZB5AVG4		
	Yellow	ZB5AVG5		
	Blue	ZB5AVG6		
		24 Vac/Vdc	White	ZB5AV18B1
Green			ZB5AV18B3	
Red			ZB5AV18B4	
Yellow			ZB5AV18B5	
Blue			ZB5AV18B6	
White			ZB5AV18G1	
110–120 Vac		Green	ZB5AV18G3	
		Red	ZB5AV18G4	
		Yellow	ZB5AV18G5	
		Blue	ZB5AV18G6	

[57] For use in bright ambient conditions (i.e., sunlight).

[58] Order bulb separately; see Table 19.183 BA9s Bulbs, page 19-61. For BA9 LED, see Table 19.403 Lamps, BA9s Base, page 19-129.

[59] For Quick-Connect version, add "3" to the end of the catalog number Example: ZB5AVJ13 (Quick-Connect size 1 x 0.250" or 2 x 0.110").

[60] For 240 V LED, replace the "B" or "G" with "M". (Example: ZB5AVB1 (24V) to ZB5AVM1 (240V))



XB5 Illuminated Operators

Table 19.155: Heads for Momentary Illuminated Push Buttons

Shape of Head	Type of Push	Color	Catalog Number
Only use with Protected LED™ light modules			
	Flush	White	ZB5AW313
		Green	ZB5AW333
		Red	ZB5AW343
		Yellow	ZB5AW353
	Flush with clear boot	Blue	ZB5AW363
		White	ZB5AW513
		Green	ZB5AW533
		Red	ZB5AW543
	Flush for insertion of legend	Yellow	ZB5AW553
		Blue	ZB5AW563
		White	ZB5AA18
		Green	ZB5AA38
	Flush for insertion of legend	Red	ZB5AA48
		Yellow	ZB5AA58
		Blue	ZB5AA68
		White	ZB5AA113
	Extended	Green	ZB5AW133
		Red	ZB5AW143
		Yellow	ZB5AW153
		Blue	ZB5AW163
	Flush for insertion of legend	White	ZB5CW313
		Green	ZB5CW333
		Red	ZB5CW343
		Yellow	ZB5CW353
	Flush for insertion of legend	Blue	ZB5CW363
		White	ZB5CW113
		Green	ZB5CW133
		Red	ZB5CW143
	Extended	Yellow	ZB5CW153
		Blue	ZB5CW163
		White	ZB5AW31
		Green	ZB5AW33
	Flush	Red	ZB5AW34
		Yellow	ZB5AW35
		Blue	ZB5AW36
		Clear	ZB5AW37
	Extended	White	ZB5AW11
		Green	ZB5AW13
		Red	ZB5AW14
		Yellow	ZB5AW15
	Extended	Blue	ZB5AW16
		Clear	ZB5AW17

Table 19.156: Illuminated Push-on/Push-off Operators

Shape of Head	Type of Push	Color of Lens	Catalog Number
Only use with Protected LED light modules			
	Flush	White	ZB5AH013
		Green	ZB5AH033
		Red	ZB5AH043
		Yellow	ZB5AH053
	Extended	Blue	ZB5AH063
		White	ZB5AH13
		Green	ZB5AH33
		Red	ZB5AH43
	Extended	Yellow	ZB5AH53
		Blue	ZB5AH63

For legends, refer to XB5 Legend Holders, page 19-58, XB5 Legend Inserts, page 19-59, and Table 19.178 Sheets of Legends for Push Buttons, Switches, and Pilot Lights, page 19-60





ZB5AW7A3741



ZB5AW7A1721

Table 19.157: Two Button with Clear Pilot Light, Momentary







Shape of Head	Description	Marking	Cap Color	Degree of Protection	Catalog Number	
No Marking						
	Two flush	—	Green Red	IP66 IP69K	ZB5AW7A3740	
		—	White Black		ZB5AW7A1720	
	One flush One extended	—	Green Red		ZB5AW7L3740	
Premarked						
	Two flush	"I" (white) "O" (white)	Green Red	IP66 IP69K	ZB5AW7A3741	
		"I" (black) "O" (white)	White Black		ZB5AW7A1721	
	One flush One extended	"I" (white) "O" (white)	Green Red		ZB5AW7L3741	
	Two flush	"i" (black) "I" (white)	White Black		ZB5AW7A1724	
	Two flush	"+" (black) "- " (black)	White White		ZB5AW7A1715	
Without caps						
Two flush without caps					IP66, IP69K	ZB5AW7A9

Table 19.158: Heads for Maintained Illuminated Push Buttons

Shape of Head	Type of Push	Color	Catalog Number
Only use with Protected LED light modules			
	Turn-to-Release Mushroom (40 mm)	White	ZB5AW713
		Green	ZB5AW733
		Red	ZB5AW743
		Yellow	ZB5AW753
		Blue	ZB5AW763



ZB5AW7



ZB5AT8643M

Table 19.159: Emergency Stop, Trigger Action and Mech Latching Push Button with Mech State Indicator for Elevator Inspection Box Applications—Heads Only

Shape of Head	Type of Reset	Color	Catalog Number
	Push-pull (40 mm)	Red	ZB5AT8643M

NOTE: ZB5AT8643M not to be used with ZBZ16* guard.

Table 19.160: Illuminated Selector Switches, Standard Lever

Shape of Head	Number and Type of Positions	Catalog Number [61]
Only use with Protected LED light modules		
	2-maintained	ZB5AK12•3
	2-momentary from right to left	ZB5AK14•3
	3-maintained	ZB5AK13•3
	3-momentary to center	ZB5AK15•3
	3-momentary from right to center	ZB5AK18•3
	3-momentary from left to center	ZB5AK17•3



ZB5AK1213



ZB5AK1463

Table 19.161: Sequence of Contacts on Selector Switch Bodies

Unit Type	Selector Switches														
	2-position						3-position								
Note: L=Left, C=Center, R=Right, O=Open, X=Closed															
															
Operator Plunger Position	Up	[Diagram]		[Diagram]		[Diagram]		[Diagram]		[Diagram]					
	Down	[Diagram]		[Diagram]		[Diagram]		[Diagram]		[Diagram]					
Contact Block Location	L	C	R	L	C	R	L	C	R	L	C	R			
Contacts	N.O.	O	O	O	X	X	X	X	X	O	O	O	O	X	X
	N.C.	X	X	X	O	O	O	O	O	X	X	X	X	O	O

For legends, see XB5 Legend Holders, page 19-58, XB5 Legend Inserts, page 19-59, and Table 19.178 Sheets of Legends for Push Buttons, Switches, and Pilot Lights, page 19-60.

For Caps, see Table 19.189 Lens Caps, page 19-62

[61] • Designate color as follows: 1—white, 3—green, 4—red, 5—yellow, 6—blue

XB5 Electrical Components

NOTE: For the Quick-Connect version, add the numeral **3** to the end of the number.
Example: ZB5AZ1013 (Quick-Connect size 1 x 0.250" or 2 x 0.110").



ZB5AZ101

Table 19.162: Contact Blocks
(Mounting Collar with Contact Blocks) [62] [63] [64]

Description	Type of Contact		Catalog Number
	N.O.	N.C.	
Screw clamp terminal connections	1	—	ZB5AZ101
	—	1	ZB5AZ102
	2	—	ZB5AZ103
	—	2	ZB5AZ104
	1	1	ZB5AZ105
	1	2	ZB5AZ141



ZB5AW011

Table 19.163: Complete Bodies
(Mounting Collar + Single Contact Block + Light Module with Protected LED™)

Light Source	Type of Contact [65]		Color	Supply Voltage [66]		Catalog Number
	N.O.	N.C.		24 Vac/Vdc	110–120 Vac	
Screw clamp terminal connections						
Protected LED	1	—	White	ZB5AW0B11	ZB5AW0G11	
			Green	ZB5AW0B31	ZB5AW0G31	
			Red	ZB5AW0B41	ZB5AW0G41	
			Yellow	ZB5AW0B51	ZB5AW0G51	
			Blue	ZB5AW0B61	ZB5AW0G61	
	—	1	White	ZB5AW0B12	ZB5AW0G12	
			Green	ZB5AW0B32	ZB5AW0G32	
			Red	ZB5AW0B42	ZB5AW0G42	
			Yellow	ZB5AW0B52	ZB5AW0G52	
			Blue	ZB5AW0B62	ZB5AW0G62	
	2	—	White	ZB5AW0B13	ZB5AW0G13	
			Green	ZB5AW0B33	ZB5AW0G33	
			Red	ZB5AW0B43	ZB5AW0G43	
			Yellow	ZB5AW0B53	ZB5AW0G53	
			Blue	ZB5AW0B63	ZB5AW0G63	
1	1	White	ZB5AW0B15	ZB5AW0G15		
		Green	ZB5AW0B35	ZB5AW0G35		
		Red	ZB5AW0B45	ZB5AW0G45		
		Yellow	ZB5AW0B55	ZB5AW0G55		
		Blue	ZB5AW0B65	ZB5AW0G65		



ZB5AW065



ZB5AW035

Table 19.164: Mounting Collar, Contact Block and Light Module
(with screw clamp terminal connections)

Supply	Light Source	Supply Voltage	Type of Contact [65]		Color of Light Source	Catalog Number
			N.O.	N.C.		
Screw clamp terminal connections						
Direct supply	BA9s 2.4 W max. bulb Not included [67]	< 250 Vac/ Vdc	1	—	—	ZB5AW061
			—	1	—	ZB5AW062
			2	—	—	ZB5AW063
Transformer type 1.2 VA, 6 V secondary	BA9s incandescent bulb included	110–120 Vac 50/60 Hz	1	1	—	ZB5AW065
			1	—	—	ZB5AW031
		230–240 Vac 50/60 Hz	1	—	—	ZB5AW035
			1	1	—	ZB5AW041
		440–480 Vac 60 Hz	1	—	—	ZB5AW045
			1	1	—	ZB5AW081
			1	1	—	ZB5AW085

[62] For Ring Tongue compatible blocks add "9" to the end of the catalog number (Example: ZB5AZ1029).
 [63] Electrical components with connection by printed circuit board pins are available. Refer to Catalog 9001CT0001 for more information.
 [64] Electrical components with connection by plug-in connector are available. Refer to Catalog 9001CT0001 for more information.
 [65] Can be fitted with additional contact blocks, see Table 19.166 Add-On Contact Blocks, page 19-56.
 [66] For 240V LED, replace the "B" or "G" with "M". (Example: change "ZB5AW0B11 (24 V) to ZB5AW0M11 (240 V))
 [67] Order bulbs separately, see Table 19.183 BA9s Bulbs and Associated Accessories, page 19-61



ZB5AZ009



ZBE101



ZBE203



ZBVB•

Protected LED™

Table 19.165: Body/Mounting Collar

For use with	Catalog Number
Electrical block (contact or light module)	ZB5AZ009

Table 19.166: Add-On Contact Block (with screw clamp terminal connections) [68]

Description	Type of Contact		Catalog Number
	N.O.	N.C.	
Standard single contact blocks [70][71]	1	—	ZBE101
	—	1	ZBE102
Standard double contact blocks [70][71]	2	—	ZBE203
	—	2	ZBE204
Special contact blocks for low-power switching [72]	1	1	ZBE205
	—	1	ZBE1016
Low-power switching	1	—	ZBE1016P
	—	1	ZBE1026P
Staggered contacts	1	—	ZBE1016P
	—	1	ZBE1026P
	1	—	ZBE201
	—	1	ZBE202
Overlapping N.O. + N.C.	1	1	ZB4BZ106
	—	2	ZB4BZ107

Table 19.167: Light Modules (with screw clamp terminal connections) [68][69]

Description	Supply Voltage	Color of Light Source	Catalog Number
Direct supply for BA9s (2.4 W max. bulb not included—see Table 19.183 BA9s Bulbs and Associated Accessories, page 19-61)	12 Vac/Vdc	White	ZBVJ1
		Green	ZBVJ3
		Red	ZBVJ4
		Yellow	ZBVJ5
		Blue	ZBVJ6
		Blue	ZBVJ6
24 Vac/Vdc	24 Vac/Vdc	White	ZBVB1
		Green	ZBVB3
		Red	ZBVB4
		Yellow	ZBVB5
		Blue	ZBVB6
		Blue	ZBVB6
110–120 Vac	110–120 Vac	White	ZBVG1
		Green	ZBVG3
		Red	ZBVG4
		Yellow	ZBVG5
		Blue	ZBVG6
		Blue	ZBVG6
24–120 Vac/Vdc	24–120 Vac/Vdc	White	ZBVBG1
		Green	ZBVBG3
		Red	ZBVBG4
		Yellow	ZBVBG5
		Blue	ZBVBG6
		Blue	ZBVBG6
230–240 Vac	230–240 Vac	White	ZBVM1
		Green	ZBVM3
		Red	ZBVM4
		Yellow	ZBVM5
		Blue	ZBVM6
		Blue	ZBVM6
Direct supply for BA9s (2.4 W max. bulb not included—see Table 19.183 BA9s Bulbs and Associated Accessories, page 19-61)	< 250 Vac/Vdc	—	ZBV6

[68] Electrical components with connection by printed circuit board pins are available. Refer to Catalog [9001CT0001](#) for more details.

[69] Electrical components with connection by plug-in connector are available. Refer to Catalog [9001CT0001](#) for more details.

[70] For Quick-Connect version add "3" to the end of the catalog number (Example: ZBE1013) (Quick-Connect size 1 x 0.250" or 2 x 0.110").

[71] For Ring Tongue compatible blocks add "9" to the end of the catalog number (Example: ZBE1029).

[72] Cannot stack additional contact blocks onto these blocks.



ZB5AZ009



ZBE1015



ZB4BZ1015

Table 19.168: Body/Mounting Collar

For use with	Catalog Number
Contact block or light module	ZB5AZ009

Table 19.169: Contact Blocks [73]



Spring Terminal Connections, Contacts for Standard Applications				
Description	Type of contact	 N.O.	 N.C.	Catalog Number
Contact blocks	Single	1	–	ZBE1015
		–	1	ZBE1025
	Single with body/mounting collar	1	–	ZB4BZ1015
		–	1	ZB4BZ1025
		2	–	ZB4BZ1035
		–	2	ZB4BZ1045
		1	1	ZB4BZ1055
		–	–	–
		–	–	–
		–	–	–

Table 19.170: Light Modules [73]

Spring Terminal Connections			
Description	Supply voltage	Color of light source	Catalog Number
Integral LED (to combine with heads for integral LED) 	12 Vac/Vdc	White	ZBVJ15
		Green	ZBVJ35
		Red	ZBVJ45
		Orange	ZBVJ55
	24 Vac/Vdc	Blue	ZBVJ65
		White	ZBVB15
		Green	ZBVB35
		Red	ZBVB45
		Orange	ZBVB55
		Blue	ZBVB65
	110–120 Vac	White	ZBVG15
		Green	ZBVG35
		Red	ZBVG45
		Orange	ZBVG55
	230–240 Vac	Blue	ZBVG65
		White	ZBVM15
		Green	ZBVM35
		Red	ZBVM45
		Orange	ZBVM55
		Blue	ZBVM65

[73] Additional blocks **cannot** be attached to the back of these contact blocks or light modules. However, spring terminal contact blocks can be mounted behind screw terminal contact blocks.

XB5 Legend Holders

Table 19.171: Standard (30 x 40 mm) Legend Holders for 8 x 27 mm Legends

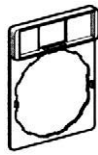

ZBZ32



ZBY101



ZBY2303

Description	Legend		Catalog Number
	Color	Text	
Without legend [74]	—	—	ZBZ32
With blank legend (for engraving)	Black or red background	—	ZBY2101
	White or yellow background	—	ZBY4101
Custom Legend (Specify Engraving) 2 lines of 11 characters (including spaces) maximum per line	Black background	White	ZBY2002
	Red background	White	ZBY2004
	White background	Black	ZBY4001
	Yellow background	Black	ZBY4005
With legend marked with international language	Black or red background [75]	O (black background)	ZBY2146
		O (red background)	ZBY2931
		I	ZBY2147
		II	ZBY2148
		O-I	ZBY2178
		I-II	ZBY2179
		I-O-II	ZBY2186
		With legend marked with English language	Black or red background [75]
AUTO-HAND	ZBY2364		
AUTO-O-HAND	ZBY2385		
CLOSE	ZBY2314		
DOWN	ZBY2308		
EMERGENCY STOP	ZBY2330		
FAST	ZBY2328		
FORWARD	ZBY2305		
FOR-REV	ZBY2371		
HAND	ZBY2316		
HAND-OFF-AUTO	ZBY2387		
INCH	ZBY2321		
JOG	ZBY2382		
LEFT	ZBY2310		
OFF	ZBY2312		
OFF-ON	ZBY2367		
ON	ZBY2311		
OPEN	ZBY2313		
POWER ON	ZBY2326		
RESET (red background)	ZBY2323		
RESET (black background)	ZBY2322		
REVERSE	ZBY2306		
RIGHT	ZBY2309		
RUN	ZBY2334		
SLOW	ZBY2327		
START	ZBY2303		
STOP	ZBY2304		
STOP-START	ZBY2366		
UP	ZBY2307		

Table 19.172: Large (30 x 50 mm) Legend Holders for 18 x 27 mm Legends

Description [76]	Color	Catalog Number
Without legend insert	—	ZBZ33
With blank legend insert	Black or red background	ZBY6101
	White or yellow background	ZBY6102

Table 19.173: 30 x 40 mm legend holder (flush mounting with bezel) for 8 x 27 mm legends

Description [76]	Color	Catalog Number
Without legend	—	ZBZ34
With blank legend	Black or red background	ZBY2H101
	White or yellow background	ZBY4H101

Table 19.174: 30 x 50 mm legend holder (flush mounting with bezel) for 18 x 27 mm legends

Description [76]	Color	Catalog Number
Without legend	—	ZBZ35
With blank legend	Black or red background	ZBY6H101
	White or yellow background	ZBY6H102



ZBZ33

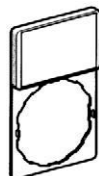

ZBY6101



ZBZ34



ZBYH101



ZBZ35

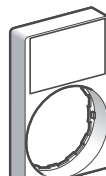

ZBY6H101

[74] For legends, see XB5 Legend Inserts Only, page 19-59.

[75] Start functions: white letters on black background. Stop functions: white letters on red background (unless otherwise specified above).

[76] For custom legends, see Table 19.178 Sheets of Legends for Push Buttons, Switches, and Pilot Lights, page 19-60

XB5 Legend Inserts

Table 19.175: Marked Legends for 8 x 27 mm (for 30 x 40 mm legend holders ZBZ32)



Color	Marking	Text	Catalog Number
Black or red background [77]	International	O (black background)	ZBY02146
		O (red background)	ZBY02931
		I	ZBY02147
		II	ZBY02148
		O-I	ZBY02178
		I-II	ZBY02179
	English	I-O-II	ZBY02186
		AUTO	ZBY02115
		AUTO-HAND	ZBY02364
		AUTO-O-HAND	ZBY02385
		CLOSE	ZBY02314
		DOWN	ZBY02308
		EMERGENCY STOP	ZBY02330
		FAST	ZBY02328
		FORWARD	ZBY02305
		FOR-REV	ZBY02371
		HAND	ZBY02316
		HAND-OFF-AUTO	ZBY02387
		INCH	ZBY02321
		JOG	ZBY02382
		LEFT	ZBY02310
		OFF	ZBY02312
		OFF-ON	ZBY02367
		ON	ZBY02311
		OPEN	ZBY02313
		POWER ON	ZBY02326
		RESET (red background)	ZBY02323
		RESET (black background)	ZBY02322
		REVERSE	ZBY02306
		RIGHT	ZBY02309
		RUN	ZBY02334
		SLOW	ZBY02327
		START	ZBY02303
STOP	ZBY02304		
STOP-START	ZBY02366		
UP	ZBY02307		

Table 19.176: Legends for Customer Engraving (inserts only)

Description	For use with	Color	Text Color	Catalog Number
8 x 27 mm	30 x 40 mm legend holders	Black or red background	White	ZBY0101
		White or yellow background	Black	ZBY0102
18 x 27 mm	30 x 50 mm legend holders	Black or red background	White	ZBY5101
		White or yellow background	Black	ZBY5102

Table 19.177: Legends for Factory Engraving (inserts only)

Description	For use with	Color	Text Color	Catalog Number
8 x 27 mm Custom Legend/Insert Only (Specify Engraving) 2 lines of 11 characters (including spaces) maximum per line (Example: ZBY01002 marked "Robot")	30 x 40 mm legend holders	Black background	White	ZBY01002
		Red background	White	ZBY01004
		White background	Black	ZBY01001
		Yellow background	Black	ZBY01005
18 x 27 mm Custom Legend/Insert Only (Specify Engraving) 3 lines of 11 characters (including spaces) maximum per line (Example: ZBY05002 marked "Robot")	30 x 50 mm legend holders	Black background	White	ZBY05002
		Red background	White	ZBY05004
		White background	Black	ZBY05001
		Yellow background	Black	ZBY05005

[77] Start functions: white letters on black background. Stop functions: white letters on red background (unless otherwise specified above).

XB5 Accessories

Table 19.178: Sheets of Legends for Push Buttons, Switches, and Pilot Lights

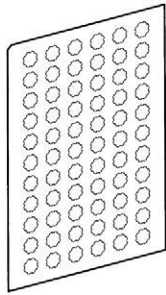

ZBY1101

Description	Marking	Text	Catalog Number	
Sheets of 66 circular peel-off transparent self-adhesive legends	Blank Round		ZBY1101	
	Blank-Square legends		ZBCY1101	
	International		O	ZBY1146
			I	ZBY1147
			II	ZBY1148
			III	ZBY1149
			STOP	ZBY1304
			→	ZBY1912
	English		HAND	ZBY1316
			OFF	ZBY1312
			ON	ZBY1311
			START	ZBY1303
	SiS Label Software	Legend Design Software: English, French, German, Spanish, Italian		XBY2U

Table 19.179: Push Button Caps—Unmarked



ZBA•



ZBL•

For use with	Type of Push	Color	Catalog Number
ZB4BA0 push button heads	Flush	White	ZBA1
		Black	ZBA2
		Green	ZBA3
		Red	ZBA4
		Yellow	ZBA5
		Blue	ZBA6
	6 colors [78]	ZBA9	
	Extended	White	ZBL1
		Black	ZBL2
		Green	ZBL3
		Red	ZBL4
		Yellow	ZBL5
		Blue	ZBL6
6 colors [78]		ZBL9	

Table 19.180: Push Button Caps—Marked



ZBA•33

For use with	Type of Push	Marking		Cap Color	Catalog Number
		Text [79]	Color		
ZB4BA0 push button heads	Flush	I [80]	White	Green	ZBA331
			Black	White	ZBA131
		START [80]	White	Green	ZBA333
			Black	White	ZBA133
		ON	White	Green	ZBA341
			Black	White	ZBA141
		UP [80]	Black	White	ZBA343
		DOWN [80]	White	Black	ZBA344
		⊕ [80]	White	Green	ZBA345
		⊖ [80]	White	Black	ZBA245
		⬆ [80]	White	Green	ZBA346
		↑	Black	White	ZBA334 [81]
			White	Black	ZBA335 [81]
		O [80]	White	Red	ZBA432
			Black	Black	ZBA232
		STOP [80]	White	Red	ZBA434
			Black	Black	ZBA234
		OFF	White	Red	ZBA435
			Black	Black	ZBA235
		R [80]	White	Blue	ZBA639

[78] Set of 6 different colored caps: white, black, green, red, yellow, blue.

[79] Start functions: white letters on black background. Stop functions: white letters on red background (unless otherwise specified).

[80] Double injection molded marking.

[81] Cap supplied not clipped-in, allowing orientation of arrow in any one of 4 directions: ↑, ↓, ←, or →



Table 19.181: Multiple-head and XB5R Push Button Caps^[82]

For use with	Type of Push	Marking	Cap Color	Catalog Number
Double push button heads Tripe push button heads ZB4RZA0 ZB5RZA0	Flush	Unmarked	White	ZBA71
		"I" black		ZBA7131
		→ black		ZBA7134
		"+" black		ZBA7138
		Unmarked		ZBA72
		"O" white	Black	ZBA7232
		"+" white		ZBA7233
		⇔ white		ZBA7235
		"I" white		ZBA7237
		Unmarked		ZBA73
		"I" white	Green	ZBA7331
		"+" white		ZBA7333
		↑ white		ZBA7335
		"I" white		ZBA7336
		Unmarked		ZBA74
		"O" white	Red	ZBA7432
		Unmarked		ZBA75
		Unmarked	Yellow	ZBA76
		Unmarked	Blue	ZBA77
		Assorted	10 colors ^[83]	ZBA79

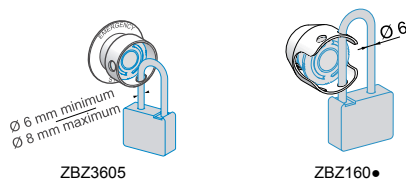

Table 19.182: Accessories

Description	Application	Color	Catalog Number
Padlocking kit Conforming to EN/ISO 13850 ^[84] (See legends below)	For Emergency Stop function only, with the following Ø 40 trigger-action push buttons: XB5AT8•, XB5AS8•, XB5AS9•, ZB5AT8•, ZB5AS8•, ZB5AS9•	Yellow	ZB3605
Metal guards Padlockable	For Emergency Stop function only with the following Ø 40 mm trigger-action push buttons: XB5AT8•, XB5AS8•, XB5AS9•, ZB5AT8• (except ZB5AT8643M), ZB5AS8•, ZB5AS9•	Chrome Plated	ZBZ1600
		Black	ZBZ1602
		Red	ZBZ1604
		Yellow	ZBZ1605
		Blue	ZBZ1606
Plastic guards ^[85]	For Emergency Stop function with XB4 and XB5 E-Stop 30 mm and 40 mm operators	Chrome plated	ZBZ1700
	Round Guard for ZB4BS5430, 2.5" dia EMO Mushroom Operators	Yellow	ZB4B21905
	Narrow Flange Guard for ZB4BS5430 or ZB4BS84430 EMO Mushroom Operators ^[86]	Yellow	ZB4B22005
	Trigger Action Guard for ZB4BS84430, 3" dia EMO Mushroom Operators	Yellow	ZB4B22105
Padlockable flaps	For push buttons	Black Red	ZB4BZ62 ZB4BZ64
Plastic blanking plug, round ^[87]	For Ø 22 mm units with round heads	Black	ZB5SZ3
Plastic blanking plug, square ^[87]	For Ø 22 mm units with square heads	Black	ZB5SZ5
Square insert	To give square appearance to ZB5A round heads	Black	ZB5AZ31
Mounting nut	Operator	—	ZB5AZ901
Tool	For tightening mounting nut ZB5AZ901	—	ZB5AZ905
Plate	Anti-rotation of head	—	ZB5AZ902
Ø 60 mm Legend for padlocking device ZB3605	Without	Yellow	ZBY9101T
	EMERGENCY STOP	Yellow	ZBY9330T

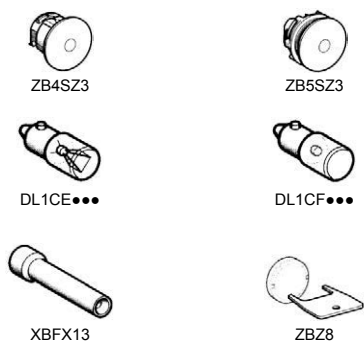

Table 19.183: BA9s Bulbs and Associated Accessories

Description	Characteristics	Catalog Number
Replacement bulbs (Type BA9s) Incandescent	6 V, 1.2 W	DL1CB006
	12 V, 2 W	DL1CE012
	24 V, 2 W	DL1CE024
	120–130 V, 2.4 W	DL1CE130
Neon bulbs	120–130 V, 1.8 mA	DL1CF110
	230–240 V, 1.8 mA	DL1CF220
Bulb extractor	—	XBFX13
Lens cap tightening tool	Illuminated push buttons with flush push	ZBZ8
Power driver bits for mounting and wiring (package of 5)	Cross headed screw (POZIDRIV type 1)	ZB4BZ905
Mounting Adapter	For mounting 22 mm push button in 30 mm KO	ZBZ41

Table 19.184: Bellows Seals for Harsh Environments (IP 69K) ^[88]

Description	For use with	Color & Material	Sold in Lots of	Catalog Number
Bellows seals for harsh environments (Humidity, dust, high-pressure cleaning)	Any Harmony XB4 metal, mushroom head push button Ø 40 mm or Ø 60 mm (except ZB4BR•16)	Red Silicone	2	ZBZ48
		Black EPDM	2	ZBZ28
		Black EPDM	2	ZBZ58

[82] Sold in lots of 10.

[83] Set of 10 different caps: white, black, green, red, yellow, blue, white "I" on green background, black "I" on white background, white "O" on red background, white "O" on black background.

[84] Standard circular legends are not compatible with this product. Use special legends ZBY•T listed above.

[85] For additional information, refer to publication 9001DB0601R6/06.

[86] Maximum panel thickness is 2.5 mm.

[87] Mounting nut included with blanking plug.

[88] Only when mounted on control stations. Use special legends ZBY••T.



ZBDD2



ZBG455



ZBG455P

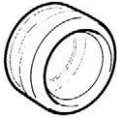

ZBP0



ZBA709

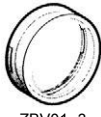

ZBV01•3



ZBV01•

Table 19.185: Boot for Standard Selector Switch Handle

Description	For use with	Catalog Number
Boot for standard handle	ZB4BD••	ZBD D2

Table 19.186: Replacement Keys

Description	Key Number	Catalog Number
Set of 2 keys	455	ZBG455
	421E	ZBG421E
	458A	ZBG458A
	520E	ZBG520E
	3131A	ZBG3131A
Set of 2 keys, One of which is supplied booted (rubber boot)	455	ZBG455P
	421E	ZBG421EP
	458A	ZBG458AP
	520E	ZBG520EP
	3131A	ZBG3131AP

Table 19.187: Clear Boots

Description	For use with	Material	Catalog Number
Single boots	Booted push buttons with circular head	Silicone	ZBPA
	Booted push buttons with circular head used in food industry applications		ZBP0A
Double boots	Double-headed push buttons, two flush		ZBA708
	Double-headed push buttons, one flush + one projecting		ZBA710
Triple boot	Triple-headed push buttons, two flush + one projecting	ZBA709	

Table 19.188: Colored boots

Description	Color	Catalog Number
Single boot (can be replaced without dismantling the head)	Black	ZB2BP012
	Green	ZB2BP013
	Red	ZB2BP014
	Yellow	ZB2BP015
	Blue	ZB2BP016

Table 19.189: Lens Caps

For use with	Color	Catalog Number
Lens caps for Protected LED™ light modules		
Pilot lights	White	ZBV0113
	Green	ZBV0133
	Red	ZBV0143
	Yellow	ZBV0153
	Blue	ZBV0163
Illuminated push buttons with flush push	White	ZBW9113
	Green	ZBW9133
	Red	ZBW9143
	Yellow	ZBW9153
	Blue	ZBW9163
Illuminated push buttons with extended push	White	ZBW9313
	Green	ZBW9333
	Red	ZBW9343
	Yellow	ZBW9353
	Blue	ZBW9363
Lens caps for BA9 light modules		
Pilot lights	White	ZBV011
	Green	ZBV013
	Red	ZBV014
	Yellow	ZBV015
	Blue	ZBV016
	Clear	ZBV017
	Illuminated push buttons with flush push	White
Green		ZBW913
Red		ZBW914
Yellow		ZBW915
Blue		ZBW916
Clear		ZBW917
Illuminated push buttons with extended push		White
	Green	ZBW933
	Red	ZBW934
	Yellow	ZBW935
	Blue	ZBW936
	Clear	ZBW937
	Square lens caps for Protected LED light modules (ZB5C operators only)	
Pilot lights	White	ZBCV0113
	Green	ZBCV0133
	Red	ZBCV0143
	Yellow	ZBCV0153
	Blue	ZBCV0163
Illuminated push buttons with flush push	White	ZBCW9113
	Green	ZBCW9133
	Red	ZBCW9143
	Yellow	ZBCW9153
	Blue	ZBCW9163
Illuminated push buttons with extended push	White	ZBCW9313
	Green	ZBCW9333
	Red	ZBCW9343
	Yellow	ZBCW9353
	Blue	ZBCW9363

New!

XB5R Plastic and XB4R Metal Wireless, Batteryless Push Buttons



XB5RFA02



Table 19.190: Ready-to-use Packs [89]

Description	Transmitter Type	Voltage Receiver V	Receiver Type	Catalog Number
Packs include: - 1 push button/transmitter - 1 receiver The push button and receiver are factory-paired [90]	Ø 22 mm plastic head + 1 set of 10 different colored caps	~ / --- 24 to 240	Programmable receiver with: - 2 relay outputs type RT 3A[91]	XB5RFA02
	Ø 22 mm metallic head + 1 set of 10 different colored caps	--- 24		XB4RFA02
Packs include: - 1 push button/transmitter in handy box [93] - 1 receiver The push button and receiver are factory-paired [90]	Ø 22 mm plastic head + 1 set of 10 different colored caps	~ / --- 24 to 240	Programmable receiver with: - 2 relay outputs type RT 3A[91]	XB5RMA04
	Ø 22 mm metallic head + 1 operator head	--- 24		XB5RMB03



ZBRT1



ZB4RZA0



ZB5RTA4

Table 19.191: Transmitter Components for Wireless, Batteryless Push Buttons

Description	Type of Push	Cap Color	Catalog Number
Transmitter for wireless, batteryless push buttons [94]	1 radio frame sent at the push of the button	—	ZBRT1
	Dual Action: 1 radio frame sent at the push of the button 1 radio frame sent at therelease of the button	—	ZBRT2
Spring return push button heads for transmitter ZBRT1	Plastic	Without cap [96]	ZB5RZA0
	Metal	Without cap [96]	ZB4RZA0
Wireless, batteryless push buttons including: - a transmitter fitted with mounting collar - a spring return push button head with clipped-in cap [97]	Plastic	White	ZB5RTA1
		Black	ZB5RTA2
		Green	ZB5RTA3
		Green with white "I"	ZB5RTA331
		Red	ZB5RTA4
		Red with white "O"	ZB5RTA432
	Metal	Yellow	ZB5RTA5
		Blue	ZB5RTA6
		White	ZB4RTA1
		Black	ZB4RTA2
		Green	ZB4RTA3
		Green with white "I"	ZB4RTA331
		Red	ZB4RTA4
		Red with white "O"	ZB4RTA432
Yellow	ZB4RTA5		
Blue	ZB4RTA6		

[89] Wireless and batteryless push button and receiver, factory-paired.
 [90] For additional components, these devices can be field-paired.
 [91] Supplied with output function set to momentary. Outputs programmable to maintained and Start-Stop.
 [92] Non-programmable momentary output function.
 [93] Supplied with a magnet.
 [94] Mounting collar ZB5AZ009 (plastic) or ZB4BZ009 (metal) to be ordered separately.
 [95] Only heads ZB4RZA0 and ZB5RZA0 are mechanically compatible.
 [96] Cap to be ordered separately: see Caps for Harmony Push Button Heads ZB5RZA0 and ZB4RZA0.
 [97] This cap is fitted by Schneider Electric and cannot be removed (risk of damage).



ZBRRA

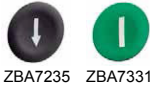

ZBA7235 ZBA7331



ZBA7432



ZBA79



ZBRM22



ZBRACS



XALD02H7

New!

Table 19.192: Programmable Receivers

Description	Output Type	Voltage Receiver V	Catalog Number
Programmable receivers equipped with: - 2 buttons ("Scroll-through", "Ok") - 6 indicating LEDs (power ON, outputs, signal strength)	4 PNP outputs, 200 mA / 24 V	--- 24	ZBRRC
	2 relay outputs type RT 3A [98]	~/--- 24 to 240	ZBRRD
	2 relay outputs type RT 3A [98]	~/--- 24 to 240	ZBRRA

NOTE: Also refer to Access Point for advanced features in programmable receivers.

Table 19.193: Caps for Harmony Push Button Heads ZB5RZA0 and ZB4RZA0

Description	Background Color	Marking	Sold in lots of	Catalog Number	
Sets of 10 different colored caps with identical marking [99]	White	Without	10	ZBA71	
		"I" (black)	10	ZBA7131	
		"4" (black)	10	ZBA7134	
		"+" (black)	10	ZBA7138	
	Black	Without	10	ZBA72	
		"O" (white)	10	ZBA7232	
		"+" (white)	10	ZBA7233	
		"0" (white)	10	ZBA7235	
	Green	"I" (white)	10	ZBA7237	
		Without	10	ZBA73	
		"I" (white)	10	ZBA7331	
		"+" (white)	10	ZBA7333	
	Red	"4" white	10	ZBA7335	
		"II" (white)	10	ZBA7336	
		Without	10	ZBA74	
	Yellow	"O" (white)	10	ZBA7432	
	Blue	Without	10	ZBA75	
		Without	10	ZBA76	
	Set of 10 different colored caps with different markings [99]	White, black, green, red, yellow, blue, white "I" on green background, black "I" on white background, white "O" on red background, white "O" on black background		10	ZBA79

Table 19.194: Boxes for Wireless, Batteryless Push Buttons

Description	For use with:	Marking	Sold in lots of	Catalog Number
Mobile box, plastic, empty [100]	For mobile and fixed applications with wireless and batteryless push buttons	1 cut-out	1	ZBRM21
		2 cut-outs	1	ZBRM22
	Support for tube or wall specific for ZBRM21 and ZBRM22	—	1	ZBRACS
Empty plastic boxes for wireless and batteryless pushbuttons [101]	For fixed or on-board wireless and batteryless pushbuttons	1 cut-out	1	XALD01H7
		2 cut-outs	1	XALD02H7

XB5R and XB4R Accessories

Table 19.195: Accessories

Description	For use with:	Marking	Sold in lots of	Catalog Number
External antenna [102]	Between transmitter and receiver, used to increase the range and/or get around obstacles	~/--- 24 to 240 V - 5m cable - 1 power-ON LED - 2 LEDs reception/transmission	1	ZBRA1
Mounting collar	—	Plastic Metal	10 10	ZB5AZ009 ZB4BZ009
Legend plate, 27 x 8 mm, for engraving	For adhering to handy box ZBRM01	Self-adhesive, blank, black background	10	ZBY0101T
External antenna access point 2 m/6.56 ft cable with 1 RF connector	Access point (ZBRN1 or ZBRN2) Used to increase the distance of transmission			ZBRA2

NOTE: The ZBRN2 has embedded communication port for Modbus Serial Line, where as ZBRN1 must be plugged with a communication module to support different protocols.



ZBRA1



ZBRA2

[98] Supplied with output function set to momentary Outputs programmable to maintained and Start-Stop.

[99] Cap can be clipped-in at 90° steps, through 360°.

[100] Cannot be used for wired contacts (no cable gland outlet).

[101] Box equipped with cable gland outlets, compatible with Harmony ZB5 push button heads.

[102] Not wired to the receiver.

Refer to Catalog [DIA5ED2121213EN](#)

New!

ZBRN1 and ZBRN2 Access Points

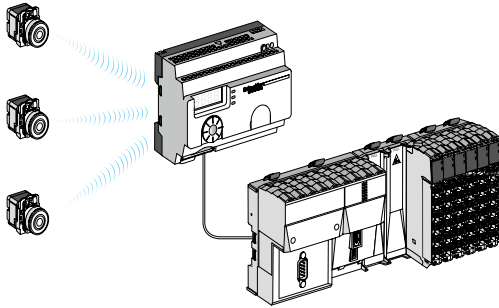

Radio transmission between 3 transmitters and 1 Access Point

The access point of Harmony wireless and batteryless range provides network connectivity openness by operating as an intermediate equipment between the transmitter and the PLC (Programmable Logic Controller). The access point receives radio signals from the transmitters and converts them to communication protocols. Based on the model, it is connected to the PLC using either RS485 Modbus Serial line or Modbus/TCP protocol.

The access point can be used with transmitters such as XB4R and XB5R wireless and batteryless push buttons, rope pull switch, mushroom head pushbutton (1), and all PLCs that support Modbus Serial line over RS485 or Modbus/TCP protocols.

Depending on the application, an external or a relay antenna can be used to improve signal reception. An access point can support up to 60 radio transmitters



ZBRN2

ZBRN1



ZBRCETH

Table 19.196: Configurable Access Points

Description	Data Function	Output Type	Receiver Voltage (V)	Catalog Number
Configurable access points equipped with: - 7-segment display - jog dial - 8 indicating LEDs (power ON, functions mode, communication status, signal strength) - external antenna connector and protective plug	Monostable (adjustable from 100 ms to 1 s)	2 RS485 connectors that provides connectivity for Modbus RS485 Serial line	\sim / --- 24 to 240	ZBRN2
	Monostable (adjustable from 100 ms to 1 s)	1 slot for communication module ZBRCETH (should be ordered separately)	\sim / --- 24 to 240	ZBRN1

Table 19.197: Communication Module

Description	Characteristics	Communication Port	Catalog Number
Modbus/TCP network communication module	Modbus/TCP protocol with embedded Web pages in 5 languages for configuration, monitoring and diagnostics	2 RJ45 connectors that provides connectivity for daisy chain and daisy chain loop operation	ZBRCETH

Biometric Switches

The biometric switches of the Harmony® XB5S range are designed to control and secure access to systems and machines by checking users' authorization through fingerprint recognition.

The following types of biometric switches are available:

- Stand-alone biometric switches
 - type XB5S1, with 2 fixed states (bistable)
 - type XB5S2, with pulse control (monostable)
- Stand-alone USB biometric switches
 - type XB5S3, with 2 fixed states (bistable)
 - type XB5S4, with pulse control (monostable)
- USB biometric switches dedicated to Schneider HMI
 - type XB5S5, connected permanently with HMI

The biometric switches are aimed at 2 categories:

- Administrators, who decide and manage the list of users
 - the only people who can record the fingerprints in the device memory
- Users, who are authorized to use the biometric switch as a control unit
 - at least 1 of their fingerprints should be recorded in the device memory
 - access is granted when the finger is placed on the sensing screen

The USB switches communicate with the PC/HMI via the USB port to manage the user database. This database can be visualized, saved, and duplicated by PC/HMI with XB5SSoft application [103] [104]. The fingerprint records can also be erased in the absence of users.

The Schneider HMI [105] with VijeoDesigner software [106] enables the switches to authorize different access levels and trace HMI operations of each user.

The switch operates on 24 Vdc and provides protection against:

- Reverse polarity
- Overload and short-circuit (switching capacity ≤ 200 mA)

Mounting

The product is of monolithic design (a single plastic housing) and is mounted by means of a nut (hand-tightened without need for tools) in a standard 22.5 mm/0.886 in. diameter hole. It can be installed on a flat, horizontal, or vertical surface.

A protective cover is available as an accessory to protect the active face of the sensing screen. This cover is mounted using a self-adhesive hinge.

A Female/Female USB extension cable makes it possible for the USB biometric switch to have the female USB port within a 22 mm/0.866 in. diameter hole on the control panel front.

Environment

- Conformity to standards: UL, CSA, GOST, and CE
- Product certifications:
 - CSA C22-2 No. 14
 - UL 508
 - IEC 61000-6-2 and IEC 61000-6-4
- Degree of protection conforming to standard IEC 60529:
 - IP 65
 - NEMA 12
- Ambient air temperature:
 - For storage: -13 to 158°F (-25 to 70° C)
 - For operation: 23 to 122°F (-5 to 50° C)



Stand-alone biometric switch
(XB5S1/XB5S2)



Stand-alone USB biometric switch
(XB5S3/XB5S4)



USB biometric switch dedicated to Schneider HMI
(XB5S5)

[103] Compatible with all versions of Harmony XB5SSoft application. The XB5SSoft is a freeware application and can be downloaded from our website www.schneider-electric.com.

[104] The user database cannot be uploaded from USB biometric switch to the PC.

[105] Compatible with Magelis iPC, STU, OT, GXO, GT (except GT1000 series), GK, GH, and GTO models.

[106] Compatible with VijeoDesigner HMI editor software V6.1, Service pack 2.

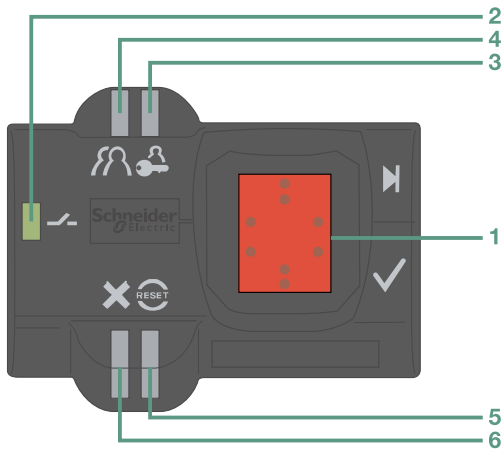

Description

- The stand-alone biometric switch (XB5S1/XB5S2) consists of a dark gray housing, with the following on its front face:
 - A sensing screen 1 that allows the registration and subsequent recognition of the registered fingerprints,
 - A green LED output state indicator 2 that illuminates when the output is activated (solid-state N.O. contact),
 - An orange LED 3, indicating an administrator’s “Registration” mode,
 - An orange LED 4, indicating an operator’s “Registration” mode,
 - A red “RESET” LED 5 which indicates, in “Delete” mode, that the administrator is deleting all or part of the memory,
 - A red LED 6 which flashes when the reader is presented with an “unrecognized” fingerprint or in the event of incorrect operation.
- The stand-alone USB biometric switch (XB5S3/XB5S4) consists of a dark gray housing with a sensing screen 1 for fingerprints, a green LED 2 for indicating the output state, and a red LED 6 for the unrecognized fingerprint on its front face.
- The USB biometric switch dedicated to Schneider HMI (XB5S5) consists of a dark gray housing with a sensing screen 1 for fingerprints on its front face.

Table 19.198: Biometric Switch Catalog Numbers

Description	Connection	Catalog Number
Bistable biometric switch 24 V DC PNP output	By 2 m/6.56 ft cable	XB5S1B2L2
	By M12 connector	XB5S1B2M12
Monostable biometric switch 24 V DC PNP output	By 2 m/6.56 ft cable	XB5S2B2L2
	By M12 connector	XB5S2B2M12
Bistable USB biometric switch 24 V DC PNP output	By 2 m/6.56 ft cable	XB5S3B2L2
	By M12 connector	XB5S3B2M12
Monostable USB biometric switch 24 V DC PNP output	By 2 m/6.56 ft cable	XB5S4B2L2
	By M12 connector	XB5S4B2M12
USB biometric switch dedicated to Schneider HMI 24 V DC	By 2 m/6.56 ft cable	XB5S5B2L2



XB5S1B••••



XB5S3B••••



XB5SFFUSBEXT



ZB5SZ70



ZB5SZ72

Table 19.199: Accessories

Description	Function	Catalog Number
Female/Female USB extension cable with Ø 22 mm/0.866 in. female USB port on one end	For connecting biometric switch to the PC via the Ø 22 mm/0.866 in. hole on the control panel front	XB5SFFUSBEXT
Protective cover, translucent and self-adhesive	Protection of sensing screen	ZB5SZ70
Mounting nut, Ø 22 mm/0.866 in.	Spare part	ZB5SZ71
Legend plate, 27 x 8 mm/ 1.06 x 0.32 in., self-adhesive, blank, black background, for engraving	—	ZBY0101T
Stainless-steel protective cover	Protects switch from outside elements and vandalism	ZB5SZ72

New!

XB7 Push Buttons

Table 19.200: Push Buttons Without Marking



XB7NA31



XB7NL4



XB7NH2

Shape of Head	Type of Push Button	Type of Contact		Marking		Color of Push Button	Sold in Lots of	Catalog Number		
		N.O.	N.C.	Text	Color					
Spring return push button without marking										
○	Flush	1	—	—	—	White	10	XB7NA11		
		1	—	—	—	Black	10	XB7NA21		
		1	—	—	—	Green	10	XB7NA31		
		1	—	—	—	Yellow	10	XB7NA81		
		1	1	—	—	White	10	XB7NA15		
		1	1	—	—	Black	10	XB7NA25		
		1	1	—	—	Green	10	XB7NA35		
		1	1	—	—	Red	10	XB7NA45		
		1	1	—	—	Blue	10	XB7NA65		
		1	1	—	—	Yellow	10	XB7NA85		
		—	1	—	—	Red	10	XB7NA42		
		2	—	—	—	Black	10	XB7NA23		
		2	—	—	—	Green	10	XB7NA33		
		—	2	—	—	Red	10	XB7NA44		
		○	Projecting	—	1	—	—	Red	10	XB7NL42
				1	1	—	—	Red	10	XB7NL45
—	2			—	—	Red	10	XB7NL44		
Latching push button without marking										
○	Flush	1	—	—	—	Black	10	XB7NH21		
		1	—	—	—	Green	10	XB7NH31		
		1	1	—	—	Black	10	XB7NH25		
		1	1	—	—	Green	10	XB7NH35		
		1	—	—	—	Yellow	10	XB7NH81		

Table 19.201: Push Buttons With Marking



XB7NA3133



XB7NA4234



XB7NL4232

Shape of Head	Type of Push Button	Type of Contact		Marking		Color of Push Button	Sold in Lots of	Catalog Number		
		N.O.	N.C.	Text	Color					
Spring return push button with marking										
○	Flush	1	—	I	White	Green	10	XB7NA3131		
		1	—	II	White	Green	10	XB7NA3136		
		1	—	START	White	Green	10	XB7NA3133		
		1	—	‡	Black	White	10	XB7NA11343		
		1	—	†	Black	White	10	XB7NA11341		
		1	—	§	White	Black	10	XB7NA21343		
		1	—	§	White	Black	10	XB7NA21341		
		—	1	O	White	Red	10	XB7NA4232		
		—	1	STOP	White	Red	10	XB7NA4234		
		2	—	I	White	Green	10	XB7NA3331		
		2	—	II	White	Green	10	XB7NA3336		
		2	—	START	White	Green	10	XB7NA3333		
		1	1	O	White	Red	10	XB7NA4532		
		1	1	STOP	White	Red	10	XB7NA4534		
		1	1	‡	Black	White	10	XB7NA15343		
		1	1	†	Black	White	10	XB7NA15341		
		1	1	§	White	Black	10	XB7NA25343		
		1	1	§	White	Black	10	XB7NA25341		
		○	Projecting	—	1	O	White	Red	10	XB7NL4232
				—	1	STOP	White	Red	10	XB7NL4234
				1	1	O	White	Red	10	XB7NL4532
				1	1	STOP	White	Red	10	XB7NL4534

XB7 Illuminated Push Buttons with Projecting Push

Table 19.202: With Integral LED



Shape of head	Type of push and contacts	Color of lens	Sold in lots of	Unit reference by supply voltage [107]		
				24 V ~/☐	120 V ~	230 V ~
	Spring return push with N.O. and N.C. contacts [107]	Green	10	XB7NW33B1	XB7NW33G1	XB7NW33M1
		Red	10	XB7NW34B1	XB7NW34G1	XB7NW34M1
		Orange	10	XB7NW34B2	XB7NW34G2	XB7NW34M2
		Blue	10	XB7NW35B1	XB7NW35G1	XB7NW35M1
		Clear	10	XB7NW36B1	XB7NW36G1	XB7NW36M1
		Yellow	10	XB7NW37B1	XB7NW37G1	XB7NW37M1
	Latching push	Green	10	XB7NW38B1	XB7NW38G1	XB7NW38M1
		Red	10	XB7NJ03B1	XB7NJ03G1	XB7NJ03M1
		Orange	10	XB7NJ04B1	XB7NJ04G1	XB7NJ04M1
		Blue	10	XB7NJ04B2	XB7NJ04G2	XB7NJ04M2
		Clear	10	XB7NJ05B1	XB7NJ05G1	XB7NJ05M1
		Yellow	10	XB7NJ06B1	XB7NJ06G1	XB7NJ06M1
		Clear	10	XB7NJ07B1	XB7NJ07G1	XB7NJ07M1
		Yellow	10	XB7NJ08B1	XB7NJ08G1	XB7NJ08M1

Table 19.203: With BA 9s Base Fitting [108]

Shape of head	Type of push	Type of contact		Color of lights	Sold in lots of	Catalog Number 250 V ~
		N.O.	N.C.			
	Spring return	1	–	Green	10	XB7NW3361
		1	–	Red	10	XB7NW3461
		1	–	Orange	10	XB7NW3561
		1	–	Blue	10	XB7NW3661
		1	–	Clear	10	XB7NW3761
		1	–	Yellow	10	XB7NW3861
	Latching	1	–	Green	10	XB7NJ0361
		1	–	Red	10	XB7NJ0461
		1	–	Orange	10	XB7NJ0561
		1	–	Blue	10	XB7NJ0661
		1	–	Clear	10	XB7NJ0761
		1	–	Yellow	10	XB7NJ0861

XB7 Pilot Lights

Table 19.204: With Integral LED



Shape of head	Type of light source (included)	Color of lens	Sold in lots of	Catalog Number by supply voltage [109]		
				24 V ~/☐	120 V ~	230 V ~
	Integral LED	Green	10	XB7EV03BP	XB7EV03GP	XB7EV03MP
		Red	10	XB7EV04BP	XB7EV04GP	XB7EV04MP
		Yellow	10	XB7EV05BP	XB7EV05GP	XB7EV05MP
		Blue	10	XB7EV06BP	XB7EV06GP	XB7EV06MP
		Clear	10	XB7EV07BP	XB7EV07GP	XB7EV07MP
		Orange	10	XB7EV08BP	XB7EV08GP	XB7EV08MP

Table 19.205: With BA 9s base fitting

Shape of head	Supply	Color of lens	Sold in lots of	Catalog Number [109]	
				With bulb	Without bulb
	With resistor, for 130 V, 2.6 W bulb Supply voltage: 230 V ~, 50-60 Hz	Green	10	XB7EV73P	XB7EV730P
		Red	10	XB7EV74P	XB7EV740P
		Yellow	10	XB7EV75P	XB7EV750P
		Blue	10	XB7EV76P	XB7EV760P
		Clear	10	XB7EV77P	XB7EV770P
		Orange	10	XB7EV78P	XB7EV780P
	Direct for BA 9s base fitting incandescent bulb Supply voltage: ≤ 250 V [110]	Green	10	–	XB7EV63P
		Red	10	–	XB7EV64P
		Yellow	10	–	XB7EV65P
		Blue	10	–	XB7EV66P
		Clear	10	–	XB7EV67P
		Orange	10	–	XB7EV68P

[107] All product references ending in "1" are for products with "NO" contacts (example: XB7NW34B1). All product references ending in "2" are for products with "NC" contacts (example: XB7NW34B2).

[108] Bulb, 1.2 W maximum, to be ordered separately

[109] For Faston connection version (1 x 6.35 mm and 2 x 2.8 mm), add the number "3" to the end of the reference. Example: XB7EV07BP becomes XB7EV07BP3.

[110] Bulb characteristics for direct supply pilot lights: 250 V, 2.6 W.

New!

XB7 Selector Switches and Key Switches

Table 19.206: Title



Shape of head	Type of operator	Type of contact		Number and type of positions	Sold in lots of	Catalog Number	
		N.O.	N.C.				
	Standard handle, black	1	—	2, maintained		10	XB7ND21
		1	1	2, maintained		10	XB7ND25
		2	—	3, maintained		10	XB7ND33
	Key (key No. 455)	1	—	2, key withdrawal in LH position		10	XB7NG21
		2	—	3, key withdrawal in center position		10	XB7NG33

NOTE: The symbol indicates key withdrawal position(s).

New!

XB7 Mushroom Head Push Buttons

Table 19.207: Ø 40 mm Emergency Stop Trigger Action and Mechanically Latching Mushroom Head Pushbuttons



Shape of head	Type of push	Standards	Type of contact		Color	Sold in lots of	Catalog Numbers
			N.O.	N.C.			
	Turn to release	EN/IEC 60204-1, EN/ISO 13850, EN/IEC 60947-5-5, Machinery directive 2006/42/EC and UL	—	1	Red	10	XB7NS8442
			1	1	Red	10	XB7NS8445
			—	2	Red	10	XB7NS8444
	Push-pull		—	1	Red	10	XB7NT842
			1	1	Red	10	XB7NT845
			—	2	Red	10	XB7NT844
	Key release (n° 455)	—	2	Red	10	XB7NS9444	
		—	1	Red	10	XB7NS9445	

Table 19.208: Circular Legends, Yellow, For Mushroom Head Push Buttons

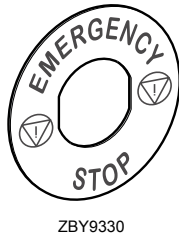

Used for "Emergency Stop" function [111]			
Conforming to Standards	Diameter (mm)	Marking on Yellow Background	Catalog Number
EN/IEC 60204-1 and EN/ISO 13850 [111]	60	ARRET D'URGENCE	ZBY9130
		EMERGENCY STOP	ZBY9330
		NOT-HALT	ZBY9230
		PARADA DE EMERGENCIA	ZBY9430
	90	ARRESTO DE EMERGENZA	ZBY9630
		ARRET D'URGENCE	ZBY8130
		EMERGENCY STOP	ZBY8330
		PARADA DE EMERGENCIA	ZBY8430
		ARRESTO DE EMERGENZA	ZBY8630

[111] For compliance with standard EN/ISO 13850, paragraph 4.4.6, the Emergency stop logo has been added.

New!

XB7 Legend Holders and Legends

Table 19.209: Standard (30 x 40 mm) Legend Holders for 8 x 27 mm Legends

Text	Sold in lots of	Catalog Number
Without legend	10	ZBZ32

Table 19.210: Legend Holder, 30 x 40 mm with Legend (black or red background)

Text	Sold in lots of	Catalog Number
With blank legend		
Without legend	10	ZBY2101
With marked legend (sold singly)		

Start functions: White characters on black background.
Stop functions: White characters on red background.

Text	Catalog Number	Text	Catalog Number
Auto	ZBY2115	Reset	ZBY2323
Down	ZBY2308	Reverse	ZBY2306
Forward	ZBY2305	Right	ZBY2309
Hand	ZBY2316	Start	ZBY2303
Inch	ZBY2321	Stop	ZBY2304
Left	ZBY2310	Up	ZBY2307
Off	ZBY2312	O	ZBY2146
On	ZBY2311	I	ZBY2147
Power on	ZBY2326	O-I	ZBY2178

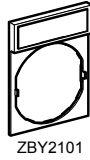

ZBY2101

Table 19.211: Standard (30 x 50 mm) Legend Holders for 18 x 27 mm Legends

Text	Sold in lots of	Catalog Number
Without legend	10	ZBZ33

New!

XB7 Accessories

Table 19.212: XB7 Push Button Accessories

Description	Color	Sold in lots of	Catalog Number
Anti-rotation plate	—	10	ZB5AZ902
Mounting nut	—	10	ZB5AZ901
Mounting nut tightening tool	—	1	ZB5AZ905
Grooved lenses for BA 9s pilot lights	White	10	ZB7EV01
	Green	10	ZB7EV03
	Red	10	ZB7EV04
	Yellow	10	ZB7EV05
	Blue	10	ZB7EV06
	Clear	10	ZB7EV07
	Orange	10	ZB7EV08
Plastic circular blanking plug (with mounting nut)	Black	10	ZB5SZ3

Table 19.213: BA 9s Bulbs

Description	Voltage (V)	Power (W)	Sold in lots of	Catalog Number
Incandescent bulbs, long life Ø 11 mm max. length 28 mm max.	6	1.2	10	DL1CB006
	24	2.0	10	DL1CE024
	130	2.6	10	DL1CE130
Neon bulbs	120–130	—	10	DL1CF110
	230–240	—	10	DL1CF220

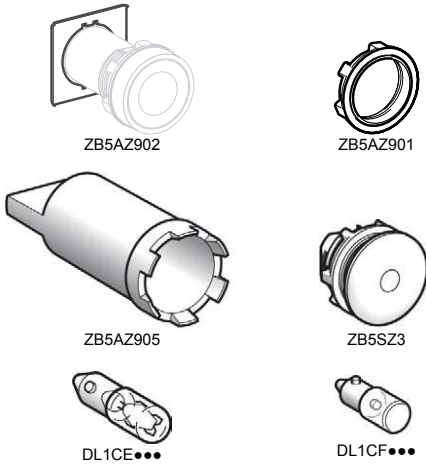

ZB5AZ902

ZB5AZ901

ZB5AZ905





ZB5SZ3

DL1CE●●●

DL1CF●●●

Type K Heavy Duty Operators

Table 19.214: Non-Illuminated Momentary Push Button Operators

Description		Color	Operator with 1 N.O. and 1 N.C. Contact (KA1) [1]	Operator with 1 N.O. Contact (KA2) [1]	Operator with 1 N.C. Contact (KA3) [1]	Operator Only with No Contacts [1]
 9001KR1B	Full Guard	Black	KR1BH13	KR1BH5	KR1BH6	KR1B
		Red	KR1RH13	KR1RH5	KR1RH6	KR1R
		Green	KR1GH13	KR1GH5	KR1GH6	KR1G
		Universal [2]	KR1UH13	KR1UH5	KR1UH6	KR1U
		Other [3]	KR1H13	KR1H5	KR1H6	KR1
 9001KR3B	No Guard	Black	KR3BH13	KR3BH5	KR3BH6	KR3B
		Red	KR3RH13	KR3RH5	KR3RH6	KR3R
		Green	KR3GH13	KR3GH5	KR3GH6	KR3G
		Universal [2]	KR3UH13	KR3UH5	KR3UH6	KR3U
		Other [3]	KR3H13	KR3H5	KR3H6	KR3
 9001KR2B	Extended Guard	Black	KR2BH13	KR2BH5	KR2BH6	KR2B
		Red	KR2RH13	KR2RH5	KR2RH6	KR2R
		Green	KR2GH13	KR2GH5	KR2GH6	KR2G
		Universal [2]	KR2UH13	KR2UH5	KR2UH6	KR2U
		Other [3]	KR2H13	KR2H5	KR2H6	KR2
 9001KR4B	1-3/8 in. (35 mm) Diameter Mushroom Button	Snap-In Plastic Mushroom Button				
		Black	KR4BH13	KR4BH5	KR4BH6	KR4B
		Red	KR4RH13	KR4RH5	KR4RH6	KR4R
		Red [4]	KR4R05H13	KR4R05H5	KR4R05H6	KR4R05
		Green	KR4GH13	KR4GH5	KR4GH6	KR4G
		Other [3]	KR4H13	KR4H5	KR4H6	KR4
		Screw-On Mushroom Button with Set Screw Security, Plastic Head				
		Black	KR24BH13	KR24BH5	KR24BH6	KR24B
		Red	KR24RH13	KR24RH5	KR24RH6	KR24R
		Green	KR24GH13	KR24GH5	KR24GH6	KR24G
		Other [3]	KR24H13	KR24H5	KR24H6	KR24
		Screw-On Metal Mushroom Button with Set Screw Security				
		Black	—	—	—	9001KR24BM
Red	—	—	—	9001KR24RM		
Green	—	—	—	9001KR24GM		
 9001KR5B	2-1/4 in. (57 mm) Diameter Mushroom Button	Snap-In Plastic Mushroom Button				
		Black	KR5BH13	KR5BH5	KR5BH6	KR5B
		Red	KR5RH13	KR5RH5	KR5RH6	KR5R
		Red [4]	KR5R05H13 [4]	KR5R05H5 [4]	KR5R05H6 [4]	KR5R05 [4]
		Green	KR5GH13	KR5GH5	KR5GH6	KR5G
		Other [3]	KR5H13	KR5H5	KR5H6	KR5
		Screw-On Mushroom Button with Set Screw Security, Plastic Head				
		Black	KR25BH13	KR25BH5	KR25BH6	KR25B
		Red	KR25RH13	KR25RH5	KR25RH6	KR25R
		Green	KR25GH13	KR25GH5	KR25GH6	KR25G
		Other [3]	KR25H13	KR25H5	KR25H6	KR25
		Screw-On Metal Mushroom Button with Set Screw Security				
		Black	—	—	—	9001KR25BM
Red	—	—	—	9001KR25RM		
Green	—	—	—	9001KR25GM		

NOTE: To select contact blocks, light modules, and accessories, see Type KA Contact Blocks, page 19-90.

Table 19.215: Color Codes

Color	KR1, 2, 3 Place Color Code in Type Number	KR4, 5, 24, 25 Place Color Code in Type Number
Blue	L	L
Yellow	Y	Y
White	W	—
Orange	S	S
Gray	E	—

NOTE: For use in hazardous locations—See Square D Offering According to Class, Division, and Group, page 19-92. Contact blocks and legend plate not included unless otherwise noted.





[1] When ordering, add prefix 9001 to the catalog number.

[2] The universal push button operators contain one each of the following color inserts: black, red, green, yellow, orange, blue and white.

[3] Choose color code from Table 19.217 Color Codes for Type K Operators, page 19-73.

[4] Knob has the words "Emergency Stop" in raised letters highlighted in white for readability.

Table 19.216: 30 mm Multifunction Operators

Description [5]	Color	With 2 N.C. Contacts (1 KA3, 1 KA5) [6]	With 1 N.O. & 1 N.C. Contact (1 KA1) [6]	Without Contacts [6] [7]
Non-Illuminated Push-Pull Mushroom Operators				
 KR9R94H13 Set Screw Style	Position, Plastic Head 1-5/8 in. (40 mm), Screw-On Momentary Pull Maintained Neutral Momentary Push [8]	Red Green Other [9]	KR8RH25 KR8GH25 KR8▼H25	— — —
	2 Position, Plastic Head 1-5/8 in. (40 mm), Screw-On Maintained Pull Maintained Push [10]	Red [11] Green Other [9]	— — —	KR9RH13 KR9GH13 KR9▼H13
	2 Position, Plastic Head 1-5/8 in. (40 mm), Screw-On Head with Set Screw Maintained Pull Maintained Push [10]	Red	—	KR9R94H13
 9001KR9RM94	2 Position, Metal Head 1-1/2 in. (40 mm) Diameter	Black	—	9001KR9BM94
		Red	—	9001KR9RM94
 9001KR9RM95	2 Position, Metal Head 2-3/8 in. (60 mm) Diameter	Green	—	9001KR9GM94
		Black	—	9001KR9BM95
		Red	—	9001KR9RM95
 9001KR9RM95		Green	—	9001KR9GM95
Description	Color	With 1 N.O. & 1 N.C. Contact (KA1)	With 2 N.O. & 2 N.C. Contacts (KA2)	Without Contacts
Non-Illuminated Turn-to-Release Mushroom Operators				
 9001KR16H2 Trigger Action	2 Position, Plastic Head Turn-to-Release Trigger Action	Red	KR16H13	KR16H2
				KR16



Screw-On Plastic Illuminated Push-Pull Mushroom Operators [6] [12] [9]

Description [5]	Voltage	With Red Knob and 2 N.C. Contacts (1 KA3, 1 KA5)	With Other Color Knob and 2 N.C. Contacts (1 KA3, 1 KA5)	With Other Color Knob Without Contacts [7]
3 Position Illuminated Momentary Pull Maintained Neutral Momentary Push [8]	110-120 V, 50-60 Hz Other—Transformer, LED, Flashing [13] Other—Full Voltage, Resistor, Neon [14]	KR8P1RH25 KR8P▲RH25 KR8P▲RH25	KR8P1▼H25 KR8P▲▼H25 KR8P▲▼H25	KR8P1▼ KR8P▲▼ KR8P▲▼
Description [5]	Voltage	With Red [11] Knob & 1 N.O. & 1 N.C. Contact (KA1)	With Other Color Knob and 1 N.O. & 1 N.C. Contact (KA1)	With Other Color Knob Without Contacts
2 Position Illuminated Maintained Pull Maintained Push	110-120 V, 50-60 Hz Other—Transformer, LED, Flashing [13] Other—Full Voltage, Resistor, Neon [14]	KR9P1RH13 KR9P▲RH13 KR9P▲RH13	KR9P1▼H13 KR9P▲▼H13 KR9P▲▼H13	KR9P1▼ KR9P▲▼ KR9P▲▼

Table 19.217: Color Codes for 30 mm Multifunction Operators ▼

Color	KR8, KR9
Black [15]	B
Red	R
Green	G
Blue	L
Yellow	Y
White	W
Orange [15]	S
Clear	C
Amber	A
Gray	—

Table 19.218: Contact Sequences

9001 KR8RH1 or H13				
(KA1)	KA3	Pull	Ctr	Push
	KA2	X	O	O
		O	O	X
9001 KR8RH25				
	KA3	X	O	O
	KA5	X	X	O
	KA2	O	O	X

NOTE: To select contact blocks, light modules, and accessories, see Type KA Contact Blocks, page 19-90.

[5] For 1-3/8 in. or 2-1/4 in. Dia. Knob:

- a) Order Type -20 or -21 knob from Additional Accessories for Type K and SK Operators, page 19-99.
- b) Order 9001K54 adapter—allows Type -20 or -21 knob to fit on push pull operators. Voids UL and NEMA 6 rating.
- c) Can order assembled operator by adding color code to Type -20 or -21. Example: 9001KR9R would be 9001KR9R20 or 9001KR9R21.

[6] When ordering, add prefix 9001 to the catalog number.

[7] These operators can be ordered complete with contact blocks. For maximum block usage, see Table 19.280 "H" Codes, page 19-93. Add the chosen "H" number to the end of the operator.

[8] For contact sequences, see Table 19.218 Contact Sequences, page 19-73

[9] ▼ Choose one color from the Color Codes table here, and insert the color code in Type number. Example: KR9 with a yellow knob = KR9Y

[10] For color codes, see Color Codes for 30 mm Multifunction Operators, page 19-73.

[11] To obtain a red knob with "Push Emergency Stop" printed on the red knob—substitute "R05" in place of "R"





[12] ▲ Add the voltage assembly code as chosen from Table 19.274 Standard Light Modules for Types K, SK, and KX Control Units, page 19-91. Example: KR8P with a 277 V 50-60 Hz voltage = KR8P8.

[13] The knob must be the same color as the LED light module chosen, for example, for a green LED, use a green knob.

[14] On neon light modules, use clear knobs only.

[15] These colors are not available on illuminated push-pull operators.

Table 19.219: Illuminated Momentary Push Button Operators

Description		Voltage and Frequency	Style	With Red Color Cap and 1 N.O. and 1 N.C. Contact (KA1) [16]	With Green Color Cap and 1 N.O. and 1 N.C. Contact (KA1) [16]	With Other Color Cap Without Contact Block [17] [18] [16]
 9001K1L1	Full Guard Illuminated Push Button Clear Plastic Top	110–120 V, 50–60 Hz	Transformer	K1L1RH13	K1L1GH13	K1L1▼
		220–240 V, 50–60 Hz	Transformer	K1L7RH13	K1L7GH13	K1L7▼
		24–28 Vac/Vdc	Full Voltage	K1L35RH13	K1L35GH13	K1L35▼
		For other voltages [19]■	Transformer or Flashing	K1L■RH13	K1L■GH13	K1L■▼
			Full Voltage	K1L■RH13	K1L■GH13	K1L■ [18]
			Resistor or Neon [20]	K1L■RH13	K1L■GH13	K1L■▼
 9001K3L1	Full Guard Illuminated Push Button Metal Top	110–120 V, 50–60 Hz	Transformer	K3L1RH13	K3L1GH13	K3L1▼
		220–240 V, 50–60 Hz	Transformer	K3L7RH13	K3L7GH13	K3L7▼
		24–28 Vac/Vdc	Full Voltage	K3L35RH13	K3L35GH13	K3L35▼
		For other voltages [19]■	Transformer or Flashing	K3L■RH13	K3L■GH13	K3L■▼
			Full Voltage	K3L■RH13	K3L■GH13	K3L■ [18]
			Resistor or Neon [20]	K3L■RH13	K3L■GH13	K3L■▼
 9001K2L1	No Guard Illuminated Push Button	110–120 V, 50–60 Hz	Transformer	K2L1RH13	K2L1GH13	K2L1▼
		220–240 V, 50–60 Hz	Transformer	K2L7RH13	K2L7GH13	K2L7▼
		24–28 Vac/Vdc	Full Voltage	K2L35RH13	K2L35GH13	K2L35▼
		For other voltages [19]■	Transformer or Flashing	K2L■RH13	K2L■GH13	K2L■ [18]
			Full Voltage	K2L■RH13	K2L■GH13	K2L■▼
			Resistor or Neon [20]	K2L■RH13	K2L■GH13	K2L■▼
 9001K2LR20	1-3/8 in. (35 mm) Illuminated Mushroom, Screw-On Plastic Head	110–120 V, 50–60 Hz	Transformer	K2L1R20H13	K2L1G20H13	Order K2L■▼ Above [22]
		220–240 V, 50–60 Hz	Transformer	K2L7R20H13	K2L7G20H13	
		24–28 Vac/Vdc	Full Voltage	K2L35R20H13	K2L35G20H13	
		For other voltages [19]■	Transformer or Flashing	K2L■R20H13	K2L■G20H13	
			Full Voltage	K2L■R20H13	K2L■G20H13	
			Resistor or Neon [20]	K2L■R20H13	K2L■G20H13	
 9001K2LR21	2-1/4 in. (57 mm) Illuminated Mushroom, Screw-On Plastic Head	110–120 V, 50–60 Hz	Transformer	K2L1R21H13	K2L1G21H13	Order K2L■▼ Above [22]
		220–240 V, 50–60 Hz	Transformer	K2L7R21H13	K2L7G21H13	
		24–28 Vac/Vdc	Full Voltage	K2L35R21H13	K2L35G21H13	
		For other voltages [19]■	Transformer or Flashing	K2L■R21H13	K2L■G21H13	
			Full Voltage	K2L■R21H13	K2L■G21H13	
			Resistor or Neon [20]	K2L■R21H13	K2L■G21H13	
			LED [21]	K2L■R21H13	K2L■G21H13	

NOTE: To select contact blocks, light modules, and accessories, see Type KA Contact Blocks, page 19-90.

Table 19.220: Color Caps

Color	Color Codes ▼		
	K1L, K2L, K3L	1-3/8 in. Mushroom	2-1/4 in. Mushroom
Red	R	R20	R21
Green	G	G20	G21
Blue	L	L20	L21
Yellow	Y	Y20	Y21
White	W	W20	W21
Clear	C	C20	C21
Amber	A	A20	A21

NOTE: UL Types 4, 13/NEMA 4, 13 For use in hazardous locations—See Square D Offering According to Class, Division, and Group, page 19-92. Contact blocks and legend plate not included unless otherwise noted.

[16] When ordering, add prefix 9001 to the catalog number.

[17] These operators can be ordered complete with contact blocks. For maximum block usage, see Table 19.280 "H" Codes, page 19-93. Add the "H" number to the end of the operator type number.

[18] Add the color code as chosen from the color cap table. Example: K2L25 with a blue 1-3/8 in. mushroom button = K2L25L20.

[19] ■ Add the voltage assembly code as chosen from Standard and Shallow Depth Light Modules, page 19-91. Example: K2L with 240 Vac/Vdc = K2L25.

[20] On neon light modules, use clear color caps only.

[21] The cap must be the same color as the LED light module chosen, e.g., for red LED, use red color cap.

[22] The only difference between a no guard (K2L_) operator and mushroom button operator is the color cap.

9001K 2-Position Selector Switches

Table 19.221: 2-Position Selector Switches

Contact Block Required				1 — Contact Closed 0 — Contact Open						
Contact Block Position	Quantity and Type KA1 or KA2 or KA3		Mount on Side KA1 or KA2 or KA3		Left	Right	Left	Right		
	<p>Top View</p>	KA1	or	KA3	KA1 #2	or	KA3 #2	1	0	0
0								1	1	0
KA1		or	KA3	KA1 #1	or	KA3 #1	1	0	0	1
							0	1	1	0
For cam, see Type K, KX, and SK Selector Switch Guide, page 19-78.							E	D		

Non-Illuminated Operators	Cat. No. [23]	Cat. No. [23]
Manual Return [24], Operator Only (without contact blocks)		
Without Knob	KS11	KS12
With Knob (select style and color from Table 19.222 Selector Switch Assembly Codes, page 19-75) [25]	KS11♦	KS12♦
Key Operated with E10 Key (Code 1,2,3) [25]	KS11K♦	KS12K♦
Operator with Contact Blocks and Standard black knob		
With 1 KA1 on Side #2	KS11BH13	—
With 1 KA1 on Side #1	KS11BH1	—
With 1 KA1 on Side #1 and 1 KA1 on side #2	KS11BH2	—
Spring Return from Left [24], Operator Only (without contact blocks)		
Without Knob	KS25	—
With Knob (select style and color from Table 19.222 Selector Switch Assembly Codes, page 19-75) [25]	KS25♦	—
Key Operated with E10 Key (Code 2 only) [26]	KS25K2	—
Spring Return from Right [24], Operator Only (without contact blocks)		
Without Knob	—	KS34
With Knob (select style and color from Table 19.222 Selector Switch Assembly Codes, page 19-75) [25]	—	KS34♦
Key Operated with E10 Key (Code 1 only)	—	KS34K1
Illuminated Operators	Cat. No. [23]	Cat. No. [23]
Manual Return [24], Operator Only (without contact blocks)		
Without Knob, 110-120V 50-60 Hz Transformer	K11J1	K12J1
With Standard Red Knob, 110-120V 50-60 Hz Transformer	K11J1R	K12J1R
With Other Color Knob and other voltage Light Module [27], [25]	K11J♦	K12J♦
Spring Return from Left [24], Operator Only (without contact blocks)		
Without Knob, 110-120V 50-60 Hz Transformer	K25J1	—
With Standard Red Knob, 110-120V 50-60 Hz Transformer	K25J1R	—
With Other Color Knob and other voltage Light Module [27], [25]	K25J♦	—
Spring Return from Right [24], Operator Only (without contact blocks)		
Without Knob, 110-120V 50-60 Hz Transformer	—	K34J1
With Standard Red Knob, 110-120V 50-60 Hz Transformer	—	K34J1R
With Other Color Knob and other voltage Light Module [27], [25]	—	K34J♦

Table 19.222: Selector Switch Assembly Code and Knob Cat. No.

Color	Standard Knob		Gloved Hand Knob	
	♦ Knob Code	Cat. No. [23]	♦ Knob Code	Cat. No. [23]
Black	B	B11	FB	B25
Red	R	R8	FR	R24
Green	G	G8	FG	G24
Yellow	Y	Y8	FY	Y24
Blue	L	L8	FL	L24
White	W	W8	FW	W24
Amber	A	A8	FA	A24
Clear	C	C8	FC	C24

Table 19.223: Key Withdrawal Codes

Code	Position
1	Left Only
2	Right Only
3	Left and Right

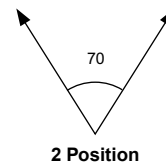

NOTE: To select and order Contact Blocks, Light Modules, Knobs, and Accessories, see Type KA Contact Blocks, page 19-90 through Hermetically Sealed Power Reed Contact Blocks, page 19-92.

[23] When ordering, add prefix 9001 to the catalog number.
 [24] These operators can be ordered complete with contact blocks. Add the "H code" from Table 19.280 "H" Codes, page 19-93 as needed for your application.
 [25] ♦ Add the knob color code from Table 19.222 Selector Switch Assembly Codes, page 19-75
 [26] Add the key withdrawal code from Table 19.223 Key Withdrawal Codes, page 19-75
 [27] ■ Add the voltage assembly code as chosen from Standard and Shallow Depth Light Modules, page 19-91. Example: K25J■ with 208Vac = K25J3

9001K 3-Position Selector Switches

Table 19.224: 3-Position Selector Switches

Contact Block Required					1 - Contact Closed 0 - Contact Open																														
Contact Block Position	Quantity and Type	Mount on Side	Left		Right		Left		Right		Left		Right		Left		Right																		
			↕	↗	↖	↗	↖	↗	↖	↗	↖	↗	↖	↗	↖	↗																			
<p>Top View</p>	KA1 ↖	or	KA3 #2	or	KA3 #2	1	0	0	1	0	0	0	0	1	1	0	0	1	0	0	1	0	0	1	0	0	1	0	0	0	1	0	1	1	0
						0	1	1	0	0	1	0	1	0	0	1	0	0	0	1	0	1	1	0	1	1	1	0	0	0	0	1			
	KA1 ↗	or	KA3 #1	or	KA3 #1	0	0	1	1	0	0	0	0	1	1	0	0	0	1	0	0	0	1	1	0	1	0	0	1	0	1	1	0	1	1
						1	1	0	0	0	1	0	1	0	0	1	0	1	0	0	0	1	0	0	1	0	0	1	0	0	1	0	1	0	0
For cam, see Type K, KX, and SK Selector Switch Guide, page 19-78.					B	C	D	E	F	G	J	L	M																						
Non-Illuminated Operators					Cat. No.	Cat. No.	Cat. No.	Cat. No.	Cat. No.	Cat. No.	Cat. No.	Cat. No.	Cat. No.	Cat. No.																					
Manual Return, Operator Only (without contact blocks) [29]																																			
Without Knob					KS42	KS43	KS44	KS45	KS46	KS47	KS49	KS401	KS402																						
With Knob ♦[30]					KS42♦	KS43♦	KS44♦	KS45♦	KS46♦	KS47♦	KS49♦	KS401♦	KS402♦																						
Key Operated with E10 Key (Code 4 through 10) ▼[31]					KS42K▼	KS43K▼	KS44K▼	KS45K▼	KS46K▼	KS47K▼	KS49K▼	KS401K▼	KS402K▼																						
Operator with Contact Blocks and Standard black knob [32]																																			
With 1 KA1 on Side #2 (H13)					KS42B-H13	KS43B-H13	KS44B-H13	KS45BH13	KS46BH13	KS47BH13	KS49BH13	KS401B-H13	KS402B-H13																						
With 1 KA1 on Side #1 (H1)					KS42BH1	KS43BH1	KS44BH1	KS45BH1	KS46BH1	KS47BH1	KS49BH1	KS401BH1	KS402BH1																						
With 1 KA1 on Side #1 and 1 KA1 on side #2 (H2)					KS42BH2	KS43BH2	KS44BH2	KS45BH2	KS46BH2	KS47BH2	KS49BH2	KS401BH2	KS402BH2																						
Spring Return from Left to Center, Operator Only (without contact blocks) [29]																																			
Without Knob					KS62	KS63	KS64	KS65	KS66	KS67	KS69	KS601	KS602																						
With Knob ♦[30]					KS62♦	KS63♦	KS64♦	KS65♦	KS66♦	KS67♦	KS69♦	KS601♦	KS602♦																						
Key Operated with E10 Key (Code 5, 6 or 9 only) ▼[31]					KS62K▼	KS63K▼	KS64K▼	KS65K▼	KS66K▼	KS67K▼	KS69K▼	KS601K▼	KS602K▼																						
Spring Return from Right to Center, Operator Only (without contact blocks) [29]																																			
Without Knob					KS72	KS73	KS74	KS75	KS76	KS77	KS79	KS701	KS702																						
With Knob ♦[30]					KS72♦	KS73♦	KS74♦	KS75♦	KS76♦	KS77♦	KS79♦	KS701♦	KS702♦																						
Key Operated with E10 Key (Code 4, 5 or 7 only) ▼[31]					KS72K▼	KS73K▼	KS74K▼	KS75K▼	KS76K▼	KS77K▼	KS79K▼	KS701K▼	KS702K▼																						
Spring Return from Both Sides to Center, Operator Only (without contact blocks) [29]																																			
Without Knob					KS52	KS53	KS54	KS55	KS56	KS57	KS59	KS501	KS502																						
With Knob ♦[30]					KS52♦	KS53♦	KS54♦	KS55♦	KS56♦	KS57♦	KS59♦	KS501♦	KS502♦																						
Key Operated with E10 Key (Code 4, 5 or 7 only) ▼[31]					KS52K▼	KS53K▼	KS54K▼	KS55K▼	KS56K▼	KS57K▼	KS59K▼	KS501K▼	KS502K▼																						
Illuminated Operators					Cat. No.	Cat. No.	Cat. No.	Cat. No.	Cat. No.	Cat. No.	Cat. No.	Cat. No.	Cat. No.																						
Manual Return, Operator Only (without contact blocks) [29]																																			
Without Knob, 110-120V 50-60 Hz Transformer					K42J1	K43J1	K44J1	K45J1	K46J1	K47J1	K49J1	K401J1	K402J1																						
With Standard Red Knob, 110-120V 50-60 Hz Transformer					K42J1R	K43J1R	K44J1R	K45J1R	K46J1R	K47J1R	K49J1R	K401J1R	K402J1R																						
With Other Color Knob and other voltage Light Module ■[33] ♦[30]					K42J■♦	K43J■♦	K44J■♦	K45J■♦	K46J■♦	K47J■♦	K49J■♦	K401J■♦	K402J■♦																						
Spring Return from Left to Center, Operator Only (without contact blocks) [29]																																			
Without Knob, 110-120V 50-60 Hz Transformer					K62J1	K63J1	K64J1	K65J1	K66J1	K67J1	K69J1	K601J1	K602J1																						
With Standard Red Knob, 110-120V 50-60 Hz Transformer					K62J1R	K63J1R	K64J1R	K65J1R	K66J1R	K67J1R	K69J1R	K601J1R	K602J1R																						
With Other Color Knob and other voltage Light Module ■[33] ♦[30]					K62J■♦	K63J■♦	K64J■♦	K65J■♦	K66J■♦	K67J■♦	K69J■♦	K601J■♦	K602J■♦																						
Spring Return from Right to Center, Operator Only (without contact blocks) [29]																																			
Without Knob, 110-120V 50-60 Hz Transformer					K72J1	K73J1	K74J1	K75J1	K76J1	K77J1	K79J1	K701J1	K702J1																						
With Standard Red Knob, 110-120V 50-60 Hz Transformer					K72J1R	K73J1R	K74J1R	K75J1R	K76J1R	K77J1R	K79J1R	K701J1R	K702J1R																						
With Other Color Knob and other voltage Light Module ■[33] ♦[30]					K72J■♦	K73J■♦	K74J■♦	K75J■♦	K76J■♦	K77J■♦	K79J■♦	K701J■♦	K702J■♦																						
Spring Return from Both Sides to Center, Operator Only (without contact blocks) [29]																																			
Without Knob, 110-120V 50-60 Hz Transformer					K52J1	K53J1	K54J1	K55J1	K56J1	K57J1	K59J1	K501J1	K502J1																						
With Standard Red Knob, 110-120V 50-60 Hz Transformer					K52J1R	K53J1R	K54J1R	K55J1R	K56J1R	K57J1R	K59J1R	K501J1R	K502J1R																						
With Other Color Knob and other voltage Light Module ■[33] ♦[30]					K52J■♦	K53J■♦	K54J■♦	K55J■♦	K56J■♦	K57J■♦	K59J■♦	K501J■♦	K502J■♦																						

Table 19.225: Selector Switch Assembly Code and Knob Cat. No. ♦

Color	Standard Knob		Gloved Hand Knob	
	[30] Knob Code	Cat. No. [28]	[30] Knob Code	Cat. No. [28]
Black	B	B11	FB	B25
Red	R	R8	FR	R24
Green	G	G8	FG	G24
Yellow	Y	Y8	FY	Y24
Blue	L	L8	FL	L24
White	W	W8	FW	W24
Amber	A	A8	FA	A24
Clear	C	C8	FC	C24

Table 19.226: Key Withdrawal Codes [34]

Code	Position
4	Left Only
5	Center Only
6	Right Only
7	Left and Center
8	Left and Right
9	Center and Right
10	Left, Center, and Right

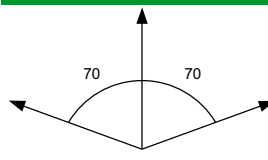

NOTE: To select and order Contact Blocks, Light Modules, Knobs, and Accessories, see Type KA Contact Blocks, page 19-90 through Hermetically Sealed Power Reed Contact Blocks, page 19-92.

19 PUSH BUTTONS AND OPERATOR INTERFACE

[28] When ordering, add prefix 9001 to the catalog number.

[29] These operators can be ordered complete with contact blocks. Add the "H code" from Table 19.280 "H" Codes, page 19-93 as needed for your application.

[30] ♦ Add the knob color code from Table 19.225 Selector Switch Assembly Code, page 19-76. For LED, knob color must match LED.

[31] ▼ Add the key withdrawal code from Key Withdrawal Codes table. Example: KS43K with key withdrawal in the right position only = KS43K6.

[32] For other color knobs replace the B with knob color code from the Selector Switch Assembly Code table.

[33] ■ Add the voltage assembly code as chosen from page 19-86.

[34] Add the key withdrawal code from Key Withdrawal Codes table. Example: KS43K with key withdrawal in the right position only = KS43K6.

9001K 4-Position Selector Switches

Table 19.227: 4-Position Selector Switches

Contact Block Required							
Contact Block Position	Quantity and Type KA1 or KA2 or KA3		Mount on Side KA1 or KA2 or KA3		1—Contact Closed 0—Contact Open		
<p>Top View</p>	KA1	or	KA3	KA1 #2	or	KA3 #2	1 0 0 0
			KA2			KA2 #2	0 0 1 0
	KA1	or	KA3	KA1 #1	or	KA3 #1	0 0 0 1
			KA2			KA2 #1	0 1 0 0
For cam, see Type K, KX, and SK Selector Switch Guide, page 19-78.							
H							

Non-Illuminated Operators		Cat. No. [35]
Manual Return [36], Operator Only (without contact blocks)		
Without Knob		KS88
With Knob♦[37]		KS88♦
Key Operated with E10 Key (Codes 11, 12, 13, 14, 15)		KS88K[38]
Illuminated Operators		Cat. No. [35]
Manual Return [36], Operator Only (without contact blocks)		
Without Knob, 110-120V 50-60 Hz Transformer		KS88J1
With Standard Red Knob, 110-120V 50-60 Hz Transformer		KS88J1R
With Other Color Knob and other voltage Light Module ■[39] ♦[37][40]		KS88J■♦

Table 19.228: Selector Switch Assembly Code and Knob Cat. No.

Color	Standard Knob		Gloved Hand Knob	
	Knob Code	Cat. No.	Knob Code	Cat. No.
Black	B	B11	FB	B25
Red	R	R8	FR	R24
Green	G	G8	FG	G24
Yellow	Y	Y8	FY	Y24
Blue	L	L8	FL	L24
White	W	W8	FW	W24
Amber	A	A8	FA	A24
Clear	C	C8	FC	C24

Table 19.229: Key Withdrawl Codes

Code	Position
11	1 and 4
12	4 only
13	1 only
14	1, 2, 3 and 4
15	2, 3, and 4

4 Position

NOTE: To select and order Contact Blocks, Light Modules, Knobs, and Accessories, see Type KA Contact Blocks, page 19-90 through Hermetically Sealed Power Reed Contact Blocks, page 19-92.

Potentiometers with Dial Plate

Table 19.230: Potentiometers with Dial Plate (not UL listed)—Maximum Voltage 300 Vac



Power	Description	Ratings	Type
2 W	Operator Only, for Single Potentiometer	NEMA 4, 13	K20
	Operator with Single Potentiometer		K21
	Operator Only, for Tandem Potentiometer		K22
	Operator with Tandem Potentiometer		K23

Table 19.231: Potentiometer Suffixes

Single Potentiometer			
Suffix [41]	Resistance	Suffix [41]	Resistance
01	50 Ω	07	5 kΩ
02	100 Ω	08	10 kΩ
04	500 Ω	09	25 kΩ
05	1 kΩ	13	500 kΩ
39	2 kΩ	37	750 kΩ
06	2.5 kΩ	14	1 MΩ
Tandem Potentiometer		Resistance	
Suffix [41]	Front	Rear	
82	1 kW	1 kW	

NOTE: Any potentiometer with a shaft 7/8" long and 1/4" diameter may be used with these operators.

[35] When ordering, add prefix 9001 to the catalog number.
 [36] These operators can be ordered complete with contact blocks. Add the "H code" from Table 19.280 "H" Codes, page 19-93 as needed for your application.
 [37] ♦ Add the knob color code from the Selector Switch Assembly Code table. For LED, knob color must match LED.
 [38] Add the key withdrawal code from the Key Withdrawal Codes table.
 [39] ■ Add the key withdrawal code from Key Withdrawal Codes table. Example: KS43K with key withdrawal in the right position only = KS43K6.
 [40] Add the knob color code from the Selector Switch Assembly Code table. For LED, knob color must match LED.
 [41] For the complete part number, add the suffix from Table 19.231 Potentiometer Suffixes, page 19-77 to the catalog number. Example: 9001K2105.

Type K, KX, and SK Selector Switch Guide

Table 19.232: 2 Position Selector Switch

If you require contact sequence—		Use Cam Type	Use Contact Block Type	Mount on side no. [42]
1	0	E	KA3	1 or 2
		D	KA2	1 or 2
0	1	E	KA2	1 or 2
		D	KA3	1 or 2

Selection

Shown below is a simplified method of selecting a selector switch to meet almost any combination of contact sequences.

Step No. 1

Determine the contact sequence(s) required. Set up a target table like the one shown for the example below.

Contact Sequence 0—contact open 1— contact closed	↖	↑	↗
A	1	0	0
B	0	1	0
C	0	0	1

Step No. 2

Look for a cam type common to all sequences in:
Table 19.232 2 Position Selector Switch, page 19-78,
Table 19.233 3 Position Selector Switch, page 19-78, or
Table 19.234 4 Position Selector Switch, page 19-78.
For the example above, Table 19.233 3 Position Selector Switch, page 19-78 would be used.
For the contact sequences A (1 0 0), B (0 1 0) and C (0 0 1) of the example above, cam types F and L are common to all three sequences.

Step No. 3

Next, use the cam type common to all the sequences (if several cam types are common, choose one) to find the operator type number. Go to the proper reference topic as indicated in the table below:

Number of Positions	Push Button Line	Reference topics
2	Type K, Type SK, Type KX	Type K, page 19-75 Type SK, page 19-85 "H" Numbers, page 19-93 Type KX with Contacts, page 19-102 Type KX without Contacts, page 19-104
3	Type K, Type SK, Type KX	Type K, page 19-76 Type SK, page 19-86 "H" Numbers, page 19-93 Type KX with Contacts, page 19-102 Type KX without Contacts, page 19-104
4	Type K, Type SK, Type KX	Type K, page 19-77 Type SK, page 19-87 Type KX, page 19-102

If for the example above a manual return operator with a standard black knob is required and:

The F cam type is chosen, the operator type number is:

- Type K—Class 9001 Type KS46B, page 19-76
- Type SK—Class 9001 Type SKS46B, page 19-86
- Type KX—Class 9001 Type KXSDFB, page 19-104

The L cam type is chosen, the operator type number is:

- Type K—Class 9001 Type KS401B, page 19-76
- Type SK—Class 9001 Type SKS401B, page 19-86
- Type KX—Class 9001 Type KXSDLB, page 19-104

Step No. 4:

Determine the contact blocks required by using the same table in Step No. 2.

If, for the example above, the F cam type is chosen:

- Use a 9001KA3 mounted on side no. 2 for sequence A (1 0 0).
- Use a 9001KA3 mounted on side no. 1 for sequence B (0 1 0).
- Use a 9001KA2 mounted on side no. 1 or 2 for sequence C (0 0 1).

If, for the example above, the L cam type is chosen:

- Use a 9001KA2 mounted on side no. 2 for sequence A (1 0 0).
 - Use a 9001KA2 mounted on side no. 1 or a 9001KA3 mounted on side no. 2 for sequence B (0 1 0).
 - Use a 9001KA3 mounted on side no. 1 for sequence C (0 0 1).
- One Type KA1 double circuit block can be used in place of one Type KA2 single circuit block plus one Type KA3 single circuit block mounted on the same side.

Table 19.233: 3 Position Selector Switch

If you require contact sequence—			Use Cam Type	Use Contact Block Type	Mount on side no. [42]							
1	0	0		G	M	KA2	1					
					L		KA2	2				
			C	E			KA3	1				
			B	C	E	F	G	J		KA3	2	
0	1	0	B			G	J		KA5 [43]	2		
				D	E			J	L		KA2	1
				D	E						KA2	2
					F						KA3	1
0	0	1					L		KA3	2		
			B	D		F				KA2	1 or 2	
				D						KA3	1	
			B	D						KA3	2	
1	1	0	B						KA5 [43]	1		
										KA2	2	
									M	KA2	1	
			B							KA2	2	
0	1	1							KA5 [43]	1 or 2		
			B							KA3	2	
										KA2	2	
										KA5 [43]	1	
1	0	1							KA5 [43]	2		
										KA3	1	
									M	KA3	1	
				D	E			J	L		KA3	1
								KA5 [43]	1			
								KA5 [43]	2			

Table 19.234: 4 Position Selector Switch

If you require contact sequence—				Use Cam Type	Use Contact Block Type	Mount on side no. [42]
1	0	0	0	H	(A) KA3	2
0	1	0	0	H	(B) KA2	1
0	0	1	0	H	(C) KA2	2
0	0	0	1	H	(D) KA3	1
1	0	0	1	H	A & D Wired in Parallel	
1	1	0	0	H	A & B Wired in Parallel	
0	1	1	0	H	B & C Wired in Parallel	
0	0	1	1	H	C & D Wired in Parallel	
1	1	1	0	H	A, B & C Wired in Parallel	
0	1	1	1	H	B, C & D Wired in Parallel	
1	0	1	0	H	A & C Wired in Parallel	
0	1	0	1	H	B & D Wired in Parallel	
1	1	0	1	H	KA5 [43]	2
1	0	1	1	H	KA5 [43]	1

NOTE: For Outline Dimensions see Catalog 9001CT1103

NOTE: When ordering, add prefix 9001 to the catalog number.

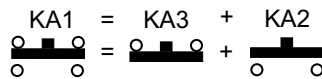

When ordering, please specify:

- Quantity
- Class Number
- Type or Catalog Number

For "H" Numbers, see Type K, SK, and KX Contact Block "H" Numbers, page 19-93

[42] See Type K, SK, and KX Contact Block "H" Numbers, page 19-93

[43] Type KA5 must be the last block on either side. If more than one KA5 is required on either side—contact your local Square D sales office.

Type K Heavy Duty Pilot Lights

When ordering, add prefix 9001 to the catalog number.

Table 19.235: Pilot Lights—UL Types 4, 13/NEMA 4 & 13[44][45]



Description	Voltage	Style	With Red Fresnel Color Cap [46]	With Green Fresnel Color Cap [46]	With Other Color Cap [46] [47]	Without Color Cap [46]
 Standard Pilot Light (Plastic Fresnel Color Cap Shown)	110–120 V, 50–60 Hz 220–240 V, 50–60 Hz 24–28 Vac/Vdc	Transformer Transformer Full Voltage	KP1R31 KP7R31 KP35R31	KP1G31 KP7G31 KP35G31	KP1■ KP7■ KP35■	KP1 KP7 KP35
	For other voltages see Standard and Shallow Depth Light Modules , page 19-91.	Transformer, Flashing or LED [48] Full Voltage, Neon or Resistor [49]	KP▲R31 KP▲R31	KP▲G31 KP▲G31	KP▲■ KP▲■	KP▲ KP▲
 Push-To-Test Pilot Light (Glass Color Cap Shown)	110–120 V, 50–60 Hz 220–240 V, 50–60 Hz 24–28 Vac/Vdc	Transformer Transformer Full Voltage	KT1R31 KT7R31 KT35R31	KT1G31 KT7G31 KT35G31	KT1■ KT7■ KT35■	KT1 KT7 KT35
	For other voltages see Standard and Shallow Depth Light Modules , page 19-91.	Transformer, Flashing or LED [48] Full Voltage, Neon or Resistor [49]	KT▲R31 KT▲R31	KT▲G31 KT▲G31	KT▲■ KT▲■	KT▲ KT▲
 Remote Test Pilot Light (Glass Color Cap Shown)	120 Vac Only 24–28 Vac Only for other voltages	Resistor [50] Full Voltage [50]	KTR38R31 KTR35R31	KTR38G31 KTR35G31	KTR38■ KTR35■	KTR38 KTR35
	See Standard and Shallow Depth Light Modules , page 19-91. [50]	Full Voltage or Resistor [50]	KTR▲R31	KTR▲G31	KTR▲■	KTR▲

Table 19.236: Color Caps

Color	Plastic Fresnel	Plastic Domed	Glass
Amber	A31	A9	A6
Blue	L31	L9	L6
Clear	C31	C9	C6
Green	G31	G9	G6
Red	R31	R9	R6
White	W31	W9	W6
Yellow	Y31	Y9	Y6

Typical Wiring Diagram

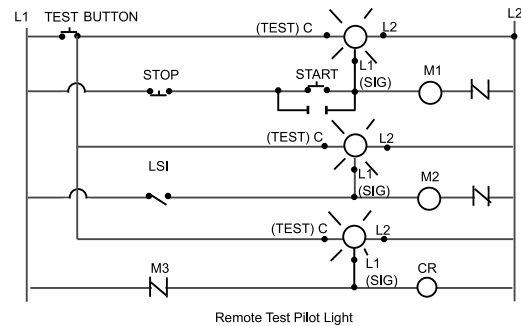
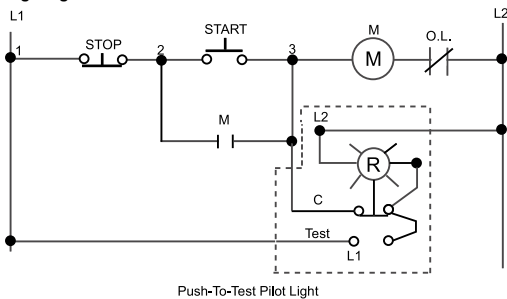

For Contact Blocks, see [Type KA Contact Blocks](#), page 19-90
 For Light Modules, see [Standard and Shallow Depth Light Modules](#), page 19-91
 For Accessories, see [Type K and SK Accessories](#), page 19-94

[44] For use in hazardous locations, see [Square D Offering According to Class, Division, and Group](#), page 19-92

[45] Legend plates not included.

[46] When ordering, add prefix 9001 to the catalog number.

[47] ■ Add the color code as chosen from [Table 19.236 Color Caps](#), page 19-79. **EXAMPLE: KP1 with a blue fresnel cap = KP1L31**

[48] The cap must be the same color as the LED light module chosen, e.g., for green LED, use green color cap.

[49] On neon light modules, use clear color caps only.

[50] On remote test pilot lights use only full voltage or resistor voltage assembly codes. Do not choose LED (exception - these LED codes are allowed: 38LG, 38LL, 38LR, 38LW, 38LY), neon or transformer codes. For AC use only.

Type K Heavy Duty Specialty Operators

Table 19.237: Joy Stick Operators—UL Types 4, 13/NEMA 4, 13 [51] [52]



Description			Operator With Contacts [53]	Operator Without Contacts [54] [53]
↕	3 Position—Center Off	Momentary Contact—Spring Return to Center	Without Latch K71H7	K71
		Maintained Contact	With Latch K70H7	K70
↔	3 Position—Center Off	Momentary Contact—Spring Return to Center	Without Latch K31H8	K31
			With Latch K30H8	K30
		Maintained Contact	Without Latch K33H8	K33
			With Latch K32H8	K32
⚡	5 Position—Center Off	Momentary Contact—Spring Return to Center	Without Latch K35H2	K35
			With Latch K34H2	K34
		Maintained Contact	Without Latch K37H2	K37
			With Latch K36H2	K36

The joy stick operator is ideal for applications where only one circuit is to be energized at one time. The three position joy stick closes one circuit in each Up-Down or Right-Left position with all circuits open in center position. The five position operator closes one circuit in each Up, Down, Left and Right position with all circuits open in center position. Momentary contact operators are spring return to the center position. Maintained operators remain in position and must be returned manually. Operators with latch cannot be operated until the latch button in center of handle is pressed.

Table 19.238: Contact Arrangements

Operator Positions	Contact Block Type	Contact Block Location	Contact	Handle position (with reference to Nib)					
				1 ↑	2 →	OFF	3 ↓	4 ←	
↔	3	KA3	POS 1 (3)	A	—	1	0	—	0
			POS 2 (4)	A	—	0	0	—	1
↕	3	KA2	POS 1 (3)	B	1	—	0	0	—
			POS 2 (4)	B	0	—	0	1	—
⚡	5	KA1	POS 1 (3)	A	0	1	0	0	0
				B	1	0	0	0	0
		KA1	POS 2 (4)	A	0	0	0	0	1
				B	0	0	0	1	0

(1) Contact Closed (0) Contact Open

Table 19.239: Selector Push Button Operators—UL Types 4, 13/NEMA 4, 13



Selector Push Button 9001KQ

Inserts are field convertible. For colors not listed, order operator without insert, plus separate color insert from Additional Accessories for Type K and SK Operators, page 19-99. Up to two Type KA contact blocks can be mounted in tandem (total of four blocks). Selector push buttons cannot be illuminated.

Contact Block Required		Two Position Operators											
		0—Contact Open		1—Contact Closed		F—Free		D—Depressed					
Quantity and Type	Mount on Side	Left	Right	Left	Right	Left	Right	Left	Right	Left	Right	Left	Right
O O 1 KA1	#2	0 0	1 0	0 0	1 0	0 0	1 1	1 1	1 0	1 0	0 0	0 0	0 0
		0 1	0 1	0 1	0 0	0 1	0 0	0 0	0 0	0 1	0 1	0 1	0 1
O O 1 KA1	#1	0 0	1 1	0 0	1 0	1 1	0 0	1 0	1 1	1 1	0 0	0 0	0 0
		0 1	0 0	0 1	0 0	0 0	0 1	0 1	0 0	0 0	0 0	0 0	0 1
Cam [55]		P		R		S		T		Y			
Color Insert		Type		Type		Type		Type		Type			
Without Insert [56] Black		KQ11		KQ12		KQ13		KQ14		KQ15			
		KQ11B		KQ12B		KQ13B		KQ14B		KQ15B			

Order Contact Blocks From Type KA Contact Blocks, page 19-90

Key operated push buttons are used wherever unauthorized use of a push button is discouraged. Examples are locking a Start push button in the extended position or locking a Stop push button in the depressed position. The operator can also be locked in the flush position—holding all contacts open. Up to two Type KA contact blocks can be mounted in tandem (total of four blocks). ("X" = locked position) [57]



Key Operated Push Button 9001KR

Table 19.240: Key Operated Push Button – UL Types 4, 13/NEMA 4, 13 [51] [52]

Description	Lockable Positions			Type [53]
	Extended	Flush	Depressed	
Push button operable only with key in lock. Key is removable in locked position only.	X — — X	— X — X	— — X X	KR131 KR132 KR133 KR137
Push button operable with or without key in lock. Push button can be locked with key only. Key removable in both locked or unlocked position.	X — — X	— X — X	— — X X	KR141 KR142 KR143 KR147
To lock the unit, rotate the key with the button in the extended position. Then, push the button to lock it in the position indicated at right. Key is removable only in this position.	— —	X —	— X	KR152 KR153

[51] For use in hazardous locations—See Square D Offering According to Class, Division, and Group, page 19-92.

[52] Legend plate and contact block not included unless otherwise noted.

[53] When ordering, add prefix 9001 to the catalog number.

[54] These operators can be ordered complete with contact blocks—a total of four (4) contact blocks can be used. Add the "H" number chosen from Table 19.280 "H" Codes, page 19-93 to the operator type number and add the cost of the "H" number to the operator cost.

[55] Cams are not interchangeable.

[56] Order color inserts from Additional Accessories for Type K and SK Operators, page 19-99.

[57] All key operated push buttons are furnished as standard with Square D no. E10 key change. See catalog 9001CT0001 for other key changes.



9001KR7U

9001KR11U



Emergency Break-Glass Operator
9001K15



Rocker Arm Operating Lever
9001K50



Push-on Push-off Module
9001K85



Wobble Stick
9001K8

NOTE: When mounted in top or bottom hole of a Type K enclosure, the Off Delay Push Button requires one additional space below or above operator. When mounted other than in top or bottom hole, device may require two additional spaces, one above and one below operator. Closing plates must be installed on unused holes.

Table 19.241: Illuminated and Non-Illuminated Dual Operators [58] [59] [60]

Description	Color	With 2 N.O. Contacts (2 KA2) [61]	With 1 N.O. & 1 N.C. Contact (KA2, KA3) [61]	Without Contacts [62] [61]
Momentary Dual Function	Universal [63] Green-Red Other [62]	KR6UH7 KR6GRH7 KR6H7	KR6UH37 KR6GRH37 KR6H37	KR6U KR6GR KR6
Momentary Interlocked Dual Function	Universal [63] Green-Red Other [62]	KR67UH7 KR67GRH7 KR67H7	KR67UH37 KR67GRH37 KR67H37	KR67U KR67GR KR67
Maintained Interlocked Dual Function	Universal [63] Green-Red Other [62]	KR7UH7 KR7GRH7 KR7H7	KR7UH37 KR7GRH37 KR7H37	KR7U KR7GR KR7
Description	Color	Contacts (KA1)		Without Contacts [62]
Both Buttons Maintained Interlocked Assembly	Universal [64] Other [65]	—		KR11U KR11▲
One Button Momentary One Button Maintained Interlocked Assembly	Universal [64] Other [65]	—		KR12U KR12▲

Table 19.242: Emergency Break-Glass Operator—UL 4, 13/NEMA 4, 13 [66]

Description	Type [61]
Operator is held in a depressed position by a glass disc. When the glass disc is broken with the hammer, button returns to a normal extended position. Package of 5 discs included with operator.	K15

Table 19.243: 9001K15 Replacement Parts

Description	Part Number
Yellow bumper	3105211101
Hammer and chain	3105206750
Lower ring nut	6512232801
Top ring nut	9001K40
Package of 5 replacement discs	9001K57
Clip to hold hammer	2540902240

Table 19.244: Rocker Arm Operating Lever

Description	Type [61]
Allows two standard push buttons to be operated independently of each other. Price does not include push buttons or legend plates. Order push buttons and legend plates from Table 19.214 Non-Illuminated Momentary Push Button Operators, page 19-72, and Table 19.284 Legend Plates, page 19-94—specify which marking is to be inverted.	K50



Table 19.245: Alternate Action—Push-on, Push-off Module

Description	Type [61]
This module can be added to standard 9001 Type K, KX, SK or T momentary push button operators. Contact blocks mounted behind this module (maximum of 2) are held in the depressed position when the operator is pressed once, and released to their normal position when the operator is pressed again. For a N.C. circuit, use a 9001KA3 or the N.C. contact of either a 9001KA1 or 9001KA4. For a N.O. circuit, use the N.O. contact of either a 9001KA4 or 9001KA6.	K85

Table 19.246: Wobble Stick

Description	Type [61]
For easy operation of any standard push button	K8

Table 19.247: Off Delay Push Button—UL Types 4, 13/NEMA 4, 13

Description	Type (All Colors)		
	Full Guard [61]	Extended Guard [61]	No Guard [61]
 Timed Contact 1 N.O. and 1 N.C.	KRD1UH1	KRD2UH1	KRD3UH1
 Timed Contact 2 N.O. and 2 N.C.	KRD1UH2	KRD2UH2	KRD3UH2



Time Delay Push Button
9001KRD

Timing period is adjustable from 0.1 second to 60 seconds and begins after button has been released. Devices include a pack of seven color inserts for color coding the push button. See Accessories, page 19-99 for Universal color insert. Contacts are quick make-quick break.

[58] Meets UL Type 13/NEMA 13 and UL Type 6/NEMA 6, which UL and NEMA consider an equivalent to UL Type 4/NEMA 4.

[59] For use in hazardous locations—See Square D Offering According to Class, Division, and Group, page 19-92.

[60] Legend plate and contact block not included unless otherwise noted.

[61] When ordering, add prefix 9001 to the catalog number.

[62] ■ Choose one color for each button. R = red, G = green, B = Black. Example: 9001KR6 with left red and right black = 9001KR6RB. See Color Codes for 30 mm Multifunction Operators, page 19-72.

[63] Universal for KR6, KR67, KR7 includes 2 inserts each of black, red and green.

[64] Universal for KR11, KR12 includes 2 each of black, red, green, yellow, orange, blue, white.

[65] ▲ Choose one color for each button. R = red, G = green, B = Black. Example: 9001KR6 with left red and right black = 9001KR6RB. See Color Codes, page 19-72.

[66] For enclosed versions see 9001KY and 9001SKY Control Stations, page 19-112.

30 mm Momentary Push Button Operators, UL Types 4, 4X, 13/
NEMA 4, 4X, 13

Table 19.248: Non-Illuminated Momentary Push Button Operators^[67]







Description	Color	Operator with 1 N.O. and 1 N.C. Contact (KA1)	Operator with 1 N.O. Contact (KA2)	Operator with 1 N.C. Contact (KA3)	Operator Only No Contacts ^[68]
 9001SKR1B Full Guard	Black	SKR1BH13	SKR1BH5	SKR1BH6	SKR1B
	Red	SKR1RH13	SKR1RH5	SKR1RH6	SKR1R
	Green	SKR1GH13	SKR1GH5	SKR1GH6	SKR1G
	Universal ^[69]	SKR1UH13	SKR1UH5	SKR1UH6	SKR1U
	Other ^[70]	SKR1■H13	SKR1■H5	SKR1■H6	SKR1■
 9001SKR3B No Guard	Black	SKR3BH13	SKR3BH5	SKR3BH6	SKR3B
	Red	SKR3RH13	SKR3RH5	SKR3RH6	SKR3R
	Green	SKR3GH13	SKR3GH5	SKR3GH6	SKR3G
	Universal ^[69]	SKR3UH13	SKR3UH5	SKR3UH6	SKR3U
	Other ^[70]	SKR3■H13	SKR3■H5	SKR3■H6	SKR3■
 9001SKR2B Extended Guard	Black	SKR2BH13	SKR2BH5	SKR2BH6	SKR2B
	Red	SKR2RH13	SKR2RH5	SKR2RH6	SKR2R
	Green	SKR2GH13	SKR2GH5	SKR2GH6	SKR2G
	Universal ^[69]	SKR2UH13	SKR2UH5	SKR2UH6	SKR2U
	Other ^[70]	SKR2■	SKR2■H5	SKR2■H6	SKR2■
Snap-In Mushroom Button					
 9001SKR4B 1-3/8 in. (35 mm) Mushroom Button	Black	SKR4BH13	SKR4BH5	SKR4BH6	SKR4B
	Red	SKR4RH13	SKR4RH5	SKR4RH6	SKR4R
	Red ^[71]	SKR4R05H13	SKR4R05H5	SKR4R05H6	SKR4R05
	Green	SKR4GH13	SKR4GH5	SKR4GH6	SKR4G
	Other ^[72]	SKR4▲H13	SKR4▲H5	SKR4▲H6	SKR4▲
Screw-On Mushroom Button with Set Screw Security					
 9001SKR5 2-1/4 in. (57 mm) Mushroom Button	Black	SKR24BH13	SKR24BH5	SKR24BH6	SKR24B
	Red	SKR24RH13	SKR24RH5	SKR24RH6	SKR24R
	Green	SKR24GH13	SKR24GH5	SKR24GH6	SKR24G
	Other ^[72]	SKR24▲H13	SKR24▲H5	SKR24▲H6	SKR24▲
	Snap-In Mushroom Button, Plastic Head				
 9001SKR5 2-1/4 in. (57 mm) Mushroom Button	Black	SKR5BH13	SKR5BH5	SKR5BH6	SKR5B
	Red	SKR5RH13	SKR5RH5	SKR5RH6	SKR5R
	Red ^[71]	SKR5R05H13	SKR5R05H5	SKR5R05H6	SKR5R05
	Green	SKR5GH13	SKR5GH5	SKR5GH6	SKR5G
	Other ^[72]	SKR5▲H13	SKR5▲H5	SKR5▲H6	SKR5▲
Screw-On Mushroom Button with Set Screw Security, Plastic Head					
 9001SKR5 2-1/4 in. (57 mm) Mushroom Button	Black	SKR25BH13	SKR25BH5	SKR25BH6	SKR25B
	Red	SKR25RH13	SKR25RH5	SKR25RH6	SKR25R
	Green	SKR25GH13	SKR25GH5	SKR25GH6	SKR25G
	Other ^[72]	SKR25▲H13	SKR25▲H5	SKR25▲H6	SKR25▲

Table 19.249: Color Codes

Color	■ SKR1, 2, 3 Place Color Code in Type Number	▲ SKR4, 5, 24, 25 Place Color Code in Type Number
Blue	L	L
Yellow	Y	Y
White	W	—
Orange	S	S
Gray	E	—

NOTE: To select and order Contact Blocks, Light Modules, Knobs, and Accessories, see Type KA Contact Blocks, page 19-90 through Hermetically Sealed Power Reed Contact Blocks, page 19-92.

NOTE: For use in hazardous locations—See Square D Offering According to Class, Division, and Group, page 19-92. Contact blocks and legend plate not included unless otherwise noted.

[67] When ordering, add prefix 9001 to the catalog number.

[68] These operators can be ordered complete with contact blocks. For maximum block usage, see Table 19.280 "H" Codes, page 19-93. Add the "H" number to the end of the operator type number.

[69] The universal push button operators include one each of the following color inserts: black, red, green, yellow, orange, blue and white.

[70] ■ See Table 19.249 Color Codes, page 19-82.

[71] Knob has the words "Emergency Stop" in raised letters highlighted in white for readability.

[72] ▲ See Table 19.249 Color Codes, page 19-82.

30 mm Multifunction Operators UL Types 4, 4X, 13/NEMA 4, 4X, 13

Table 19.250: Non-Illuminated Push-Pull Screw-on Mushroom Operators, Plastic Head^[73]

	Description	Color	With 2 N.C. Contacts (1 KA3, 1 KA5)	With 1 N.O. / 1 N.C. Contact (1 KA1)	Without Contacts ^[74]
 <p>9001SKR9R Non-Illuminated 1-5/8 in. Diameter Knob Includes Type KN179WP Legend Plate Marked Pull To Start Push To Stop</p>	3 Position				
	Momentary Pull-Maintained Neutral-Momentary Push ^[75]	Red	SKR8RH25	—	SKR8R
		Green	SKR8GH25	—	SKR8G
		Other ^[76]	SKR8▲H25	—	SKR8▲
	2 Position^[77]				
	Maintained Pull-Maintained Push	Red	—	SKR9RH13	SKR9R
Green		—	SKR9GH13	SKR9G	
Other ^[76]		—	SKR9▲H13	SKR9▲	

Table 19.251: Non-Illuminated Turn-to-Release Mushroom Operators^[73]

	Description	Color	With 1 N.O. Contact (KA1)	With 2 N.O. / 2 N.C. Contacts (2 KA1)	Without Contacts
 <p>9001SKR16H2</p>	2 Position, Plastic Head Turn-to-Release Trigger Action	Red	SKR16H13	SKR16H2	SKR16

Table 19.252: Screw-On Plastic Illuminated Push-Pull Mushroom Operators^[73]

Illuminated	Description	Voltage	With Red Knob and 2 N.C. Contacts (1 KA3, 1 KA5) ^[78]	With Other Color Knob and 2 N.C. Contacts ^[76] ^[78]	With Other Color Knob Without Contacts ^[74] ^[76] ^[78]
 <p>9001SKR9P1 Illuminated 1-5/8 in. Diameter Knob Includes Type KN179WP Legend Plate Marked Pull to Start Push To Stop</p>	3 Position				
	Momentary Pull-Maintained Neutral-Momentary Push ^[79]	110–120 V, 50–60 Hz	SKR8P1RH25	SKR8P1▲H25	SKR8P1▲
		Other—Transformer, LED, Flashing ^[80]	SKR8P♦RH25	SKR8P♦▲H25	SKR8P♦▲
		Other—Full Voltage, Resistor, Neon ^[75]	SKR8P♦RH25	SKR8P♦▲H25	SKR8P♦▲
	2 Position				
	Maintained Pull-Maintained Push	110–120 V, 50–60 Hz	SKR9P1RH13	SKR9P1▲H13	SKR9P1▲
Other—Transformer, L.E.D., Flashing ^[80]		SKR9P♦RH13	SKR9P♦▲H13	SKR9P♦▲	
Other—Full Voltage, Resistor, Neon ^[75]		SKR9P♦RH13	SKR9P♦▲H13	SKR9P♦▲	

Table 19.253: Color Codes

Color	SKR11, SKR12	SKR8, SKR9
Black ^[81]	B	B
Red	R	R
Green	G	G
Blue	L	L
Yellow	Y	Y
White	W	W
Orange ^[81]	S	S
Clear	—	—
Amber	—	A
Gray	E	—

Table 19.254: Positions for 9001SKR8RH1 or H13

	9001SKR8RH1 or H13			
	KA3	PULL	CTR	PUSH
(KA1)	X	O	O	O
	KA2	O	O	X

Table 19.255: Positions for 9001SKR8H25

	9001SKR8H25			
	KA3	PULL	CTR	PUSH
	KA5	X	O	O
	KA2	O	O	X

NOTE: To select and order Contact Blocks, Light Modules, Knobs, and Accessories, see [Type KA Contact Blocks, page 19-90](#) through [Hermetically Sealed Power Reed Contact Blocks, page 19-92](#).

^[73] When ordering, add prefix 9001 to the catalog number.
^[74] These operators can be ordered complete with contact blocks. For maximum block usage, see [Table 19.280 "H" Codes, page 19-93](#). Add the chosen "H" number to the end of the operator.
^[75] On neon light modules, use clear knobs only.
^[76] ▲ See [Table 19.253 Color Codes, page 19-83](#) and insert the color code in the Type number. Example: SKR9() with a yellow knob = SKR9Y
^[77] To obtain a red knob with "Push Emergency Stop" printed on the red knob—substitute "R05" in place of "R"
^[78] ♦ Add the voltage assembly code as chosen from [Standard and Shallow Depth Light Modules, page 19-91](#). Example: SKR8P♦ with 277 V 50–60 Hz = SKR8P8
^[79] For positions, refer to [Table 19.254 Positions for 9001SKR8RH1 or H13, page 19-83](#) and [Table 19.255 Positions for 9001SKR8H25, page 19-83](#).
^[80] The knob must be the same color as the LED light module chosen, for example, for a green LED, use a green knob.
^[81] These colors are not available on illuminated push-pull operators.

Type SK Corrosion Resistant Illuminated Operators

Table 19.256: Illuminated Push Button Operators





Description	Voltage and Frequency	Style	With Red Color Cap and 1 N.O. and 1 N.C. Contact (KA1) [82]	With Green Color Cap and 1 N.O. and 1 N.C. Contact (KA1) [82]	With Other Color Cap Without Contact Blocks [83] [82]
 9001SK1L1 Full Guard Illuminated Push Button	110–120 V, 50–60 Hz	Transformer	SK1L1RH13	SK1L1GH13	SK1L1
	220–240 V, 50–60 Hz	Transformer	SK1L7RH13	SK1L7GH13	SK1L7
	24–28 Vac/Vdc	Full Voltage	SK1L35RH13	SK1L35GH13	SK1L35
	For other voltages See Table [84]	Transformer, Flashing	SK1L■RH13	SK1L■GH13	SK1L ■
		Full Voltage	SK1L■RH13	SK1L■GH13	SK1L ■
		Resistor, Neon [85]	SK1L■RH13	SK1L■GH13	SK1L ■
LED [86]	SK1L■RH13	SK1L■GH13	SK1L ■ [87]		
 9001SK2L1 No Guard Illuminated Push Button	110–120 V, 50–60 Hz	Transformer	SK2L1RH13	SK2L1GH13	SK2L1
	220–240 V, 50–60 Hz	Transformer	SK2L7RH13	SK2L7GH13	SK2L7
	24–28 Vac/Vdc	Full Voltage	SK2L35RH13	SK2L35GH13	SK2L35
	For other voltages See Table [84]	Transformer, Flashing	SK2L■RH13	SK2L■GH13	SK2L ■
		Full Voltage	SK2L■RH13	SK2L■GH13	SK2L ■
		Resistor, Neon [85]	SK2L■RH13	SK2L■GH13	SK2L ■
LED [86]	SK2L■RH13	SK2L■GH13	SK2L ■ [87]		
 9001SK2L1R20 1-3/8 in. (35 mm) Illuminated Mushroom, Screw-On Plastic Head	110–120 V, 50–60 Hz	Transformer	SK2L1R20H13	SK2L1G20H13	Order SK2L■ [87][88]
	220–240 V, 50–60 Hz	Transformer	SK2L7R20H13	SK2L7G20H13	
	24–28 Vac/Vdc	Full Voltage	SK2L35R20H13	SK2L35G20H13	
	For other voltages See Table [84]	Transformer, Flashing	SK2L■R20H13	SK2L■G20H13	
		Full Voltage	SK2L■R20H13	SK2L■G20H13	
		Resistor, Neon [85]	SK2L■R20H13	SK2L■G20H13	
LED [86]	SK2L■R20H13	SK2L■G20H13			
 9001SK2L1R21 2-1/4 in. (57 mm) Illuminated Mushroom, Screw-On Plastic Head	110–120 V, 50–60 Hz	Transformer	SK2L1R21H13	SK2L1G21H13	Order SK2L■ [87][88]
	220–240 V, 50–60 Hz	Transformer	SK2L7R21H13	SK2L7G21H13	
	24–28 Vac/Vdc	Full Voltage	SK2L35R21H13	SK2L35G21H13	
	For other voltages See Table [84]	Transformer, Flashing	SK2L■R21H13	SK2L■G21H13	
		Full Voltage	SK2L■R21H13	SK2L■G21H13	
		Resistor, Neon [85]	SK2L■R21H13	SK2L■G21H13	
LED [86]	SK2L■R21H13	SK2L■G21H13			

Table 19.257: Color Caps

Color	Color Codes		
	SK1L/SK2L	1-3/8 in. (35 mm) Mushroom	2-1/4 in. (57 mm) Mushroom
Red	R	R20	R21
Green	G	G20	G21
Blue	L	L20	L21
Yellow	Y	Y20	Y21
White	W	W20	W21
Clear	C	C20	C21
Amber	A	A20	A21

NOTE: To select and order Contact Blocks, Light Modules, Knobs, and Accessories, see Type KA Contact Blocks, page 19-90 through Hermetically Sealed Power Reed Contact Blocks, page 19-92.

NOTE: For use in hazardous locations—See Square D Offering According to Class, Division, and Group, page 19-92. Contact blocks and legend plate not included unless otherwise noted.

[82] When ordering, add prefix 9001 to the catalog number.

[83] These operators can be ordered complete with contact blocks. For maximum block usage, see Table 19.280 "H" Codes, page 19-93. Add the "H" number to the end of the operator type number.

[84] ■ Add the voltage assembly code as chosen from Standard and Shallow Depth Light Modules, page 19-91. **EXAMPLE:** SK2L_ with 240 Vac/Vdc = SK2L25.

[85] On neon light modules, use clear color caps only.

[86] Add the color code as chosen from the color cap table below. **EXAMPLE:** SK2L25 with a blue 1-3/8 in. mushroom button = SK2L25L20.

[87] The cap must be the same color as the LED light module chosen, e.g., for green LED, use green color cap.

[88] The only difference between a no guard (SK2L) operator and mushroom button operator is the color cap.

9001SK 2-Position Selector Switches

Table 19.258: 2-Position Selector Switches

Contact Block Position	Contact Block Required				1—Contact Closed 0—Contact Open					
	Quantity and Type KA1 or KA2 or KA3		Mount on Side KA1 or KA2 or KA3		Left	Right	Left	Right		
<p>Top View</p>	KA1	or	KA3	KA1 #2	or	KA3 #2	1	0	0	1
			KA2			KA2 #2	0	1	1	0
	KA1	or	KA3	KA1 #1	or	KA3 #1	1	0	0	1
			KA2			KA2 #1	0	1	1	0
					E		D			

For Cam, see Type K, KX, and SK Selector Switch Guide, page 19-78

	Type [89]	Type [89]
Non-Illuminated Operators		
Manual Return [90], Operator Only (without contact blocks)		
Without Knob	SKS11	SKS12
With Knob [91]	SKS11♦	SKS12♦
Operator with Contact Blocks and Standard black knob		
With 1 KA1 on Side #2	SKS11BH13	—
With 1 KA1 on Side #1	SKS11BH1	—
With 1 KA1 on Side #1 and 1 KA1 on side #2	SKS11BH2	—
Spring Return from Left [90], Operator Only (without contact blocks)		
Without Knob	SKS25	—
With Knob [91]	SKS25♦	—
Spring Return from Right [90], Operator Only (without contact blocks)		
Without Knob	—	SKS34
With Knob [91]	—	SKS34♦
Illuminated Operators		
Manual Return [90], Operator Only (without contact blocks)		
Without Knob, 110-120V 50-60 Hz Transformer	SK11J1	SK12J1
With Standard Red Knob, 110-120V 50-60 Hz Transformer	SK11J1R	SK12J1R
With other Color Knob [91] and other Voltage Light Module [92]	SK11J♦	SK12J♦
Spring Return from Left [90], Operator Only (without contact blocks)		
Without Knob, 110-120V 50-60 Hz Transformer	SK25J1	—
With Standard Red Knob, 110-120V 50-60 Hz Transformer	SK25J1R	—
With other Color Knob [91] and other Voltage Light Module [92]	SK25J♦	—
Spring Return from Right [90], Operator Only (without contact blocks)		
Without Knob, 110-120V 50-60 Hz Transformer	—	SK34J1
With Standard Red Knob, 110-120V 50-60 Hz Transformer	—	SK34J1R
With other Color Knob [91] and other Voltage Light Module [92]	—	SK34J♦

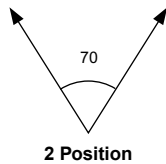

Table 19.259: Selector Switch Assembly Code and Knob Cat. No.

Color	Standard Knob		Gloved Hand Knob	
	Knob Code	Cat. No. [89]	Knob Code	Cat. No. [89]
Black	B	B11	FB	B25
Red	R	R8	FR	R24
Green	G	G8	FG	G24
Yellow	Y	Y8	FY	Y24
Blue	L	L8	FL	L24
White	W	W8	FW	W24
Amber	A	A8	FA	A24
Clear	C	C8	FC	C24

Contact Blocks: Contact Blocks, page 19-90, Hermetically Sealed Logic Reed Contact Blocks, page 19-92, Hermetically Sealed Power Reed Contact Blocks, page 19-92
Light Modules: Standard Light Modules, page 19-91
Knobs and Accessories: Additional Accessories for Type K and SK Operators, page 19-99

[89] When ordering, add prefix 9001 to the catalog number.

[90] These operators can be ordered complete with contact blocks. For maximum block usage, see Table 19.280 "H" Codes, page 19-93. Add the chosen "H" number to the end of the operator.

[91] ♦ Add the knob color code chosen from Table 19.259 Selector Switch Assembly Code and Knob Cat. No., page 19-85. For LED, knob color must match LED.

[92] ■ Add the voltage assembly code as chosen from Standard Light Modules, page 19-91. Example: K25J with 208Vac = K25J3

9001SK 3-Position Selector Switches

Table 19.260: 3-Position Selector Switches

Contact Block Required			1 — Contact Closed 0 — Contact Open																	
Contact Block Position	Quantity and Type	Mount on Side	↕↕↕		↕↕↕		↕↕↕		↕↕↕		↕↕↕		↕↕↕		↕↕↕					
<p>Top View</p>	KA1	KA3 #2	1	0	0	1	0	0	0	0	1	1	0	0	1	0	0			
	KA2	KA2 #2	0	1	1	0	0	1	0	1	0	0	1	0	0	0	1			
	KA3	KA3 #1	0	0	1	1	0	0	0	0	1	1	0	0	0	1	0			
	KA1	KA2 #1	1	1	0	0	0	1	0	1	0	0	1	0	0	0	1			
For Cam, see Type K, KX, and SK Selector Switch Guide, page 19-78			B		C		D		E		F		G		J		L		M	

Non-Illuminated Operators [93]	Type	Type	Type	Type	Type	Type	Type	Type	Type
Manual Return, Operator Only (without contact blocks) [94]									
Without Knob	SKS42	SKS43	SKS44	SKS45	SKS46	SKS47	SKS49	SKS401	SKS402
With Knob [95]	SKS42♦	SKS43♦	SKS44♦	SKS45♦	SKS46♦	SKS47♦	SKS49♦	SKS401♦	SKS402♦
Operator with Contact Blocks and Standard black knob [96]									
With 1 KA1 on Side #2 (H13)	SKS42B-H13	SKS43B-H13	SKS44B-H13	SKS45B-H13	SKS46BH13	SKS47B-H13	SKS49B-H13	SKS401B-H13	SKS402B-H13
With 1 KA1 on Side #1 (H1)	SKS42B-H1	SKS43BH1	SKS44BH1	SKS45B-H1	SKS46BH1	SKS47BH1	SKS49BH1	SKS401BH1	SKS402BH1
With 1 KA1 on Side #1 and 1 KA1 on side #2 (H2)	SKS42B-H2	SKS43BH2	SKS44BH2	SKS45B-H2	SKS46B-H2	SKS47BH2	SKS49BH2	SKS401BH2	SKS402BH2
Spring Return from Left to Center, Operator Only (without contact blocks) [94]									
Without Knob	SKS62	SKS63	SKS64	SKS65	SKS66	SKS67	SKS69	SKS601	SKS602
With Knob [95]	SKS62♦	SKS63♦	SKS64♦	SKS65♦	SKS66♦	SKS67♦	SKS69♦	SKS601♦	SKS602♦
Spring Return from Right to Center, Operator Only (without contact blocks) [94]									
Without Knob	SKS72	SKS73	SKS74	SKS75	SKS76	SKS77	SKS79	SKS701	SKS702
With Knob [95]	SKS72♦	SKS73♦	SKS74♦	SKS75♦	SKS76♦	SKS77♦	SKS79♦	SKS701♦	SKS702♦
Spring Return from Both Sides to Center, Operator Only (without contact blocks) [94]									
Without Knob	SKS52	SKS53	SKS54	SKS55	SKS56	SKS57	SKS59	SKS501	SKS502
With Knob [95]	SKS52♦	SKS53♦	SKS54♦	SKS55♦	SKS56♦	SKS57♦	SKS59♦	SKS501♦	SKS502♦

Illuminated Operators [93]	Type	Type	Type	Type	Type	Type	Type	Type	Type
Manual Return, Operator Only (without contact blocks) [94]									
Without Knob, 110-120V 50-60 Hz Transformer	SK42J1	SK43J1	SK44J1	SK45J1	SK46J1	SK47J1	SK49J1	SK401J1	SK402J1
With Standard Red Knob, 110-120V 50-60 Hz Transformer	SK42J1R	SK43J1R	SK44J1R	SK45J1R	SK46J1R	SK47J1R	SK49J1R	SK401J1R	SK402J1R
With other Color Knob [95] and other Voltage Light Module [97]	SK42J♦	SK43J♦	SK44J♦	SK45J♦	SK46J♦	SK47J♦	SK49J♦	SK401J♦	SK402J♦
Spring Return from Left to Center, Operator Only (without contact blocks) [94]									
Without Knob, 110-120V 50-60 Hz Transformer	SK62J1	SK63J1	SK64J1	SK65J1	SK66J1	SK67J1	SK69J1	SK601J1	SK602J1
With Standard Red Knob, 110-120V 50-60 Hz Transformer	SK62J1R	SK63J1R	SK64J1R	SK65J1R	SK66J1R	SK67J1R	SK69J1R	SK601J1R	SK602J1R
With other Color Knob [95] and other Voltage Light Module [97]	SK62J♦	SK63J♦	SK64J♦	SK65J♦	SK66J♦	SK67J♦	SK69J♦	SK601J♦	SK602J♦
Spring Return from Right to Center, Operator Only (without contact blocks) [94]									
Without Knob, 110-120V 50-60 Hz Transformer	SK72J1	SK73J1	SK74J1	SK75J1	SK76J1	SK77J1	SK79J1	SK701J1	SK702J1
With Standard Red Knob, 110-120V 50-60 Hz Transformer	SK72J1R	SK73J1R	SK74J1R	SK75J1R	SK76J1R	SK77J1R	SK79J1R	SK701J1R	SK702J1R
With other Color Knob [95] and other Voltage Light Module [97]	SK72J♦	SK73J♦	SK74J♦	SK75J♦	SK76J♦	SK77J♦	SK79J♦	SK701J♦	SK702J♦
Spring Return from Both Sides to Center, Operator Only (without contact blocks) [94]									
Without Knob, 110-120V 50-60 Hz Transformer	SK52J1	SK53J1	SK54J1	SK55J1	SK56J1	SK57J1	SK59J1	SK501J1	SK502J1
With Standard Red Knob, 110-120V 50-60 Hz Transformer	SK52J1R	SK53J1R	SK54J1R	SK55J1R	SK56J1R	SK57J1R	SK59J1R	SK501J1R	SK502J1R
With other Color Knob [95] and other Voltage Light Module [97]	SK52J♦	SK53J♦	SK54J♦	SK55J♦	SK56J♦	SK57J♦	SK59J♦	SK501J♦	SK502J♦

Table 19.261: Selector Switch Assembly Code and Knob Cat. No.

Color	Standard Knob		Gloved Hand Knob	
	[98] Knob Code	Cat. No. [93]	[96] Knob Code	Cat. No. [93]
Black	B	B11	FB	B25
Red	R	R8	FR	R24
Green	G	G8	FG	G24
Yellow	Y	Y8	FY	Y24
Blue	L	L8	FL	L24
White	W	W8	FW	W24
Amber	A	A8	FA	A24
Clear	C	C8	FC	C24

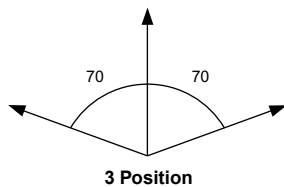

Contact Blocks: Contact Blocks, page 19-90, Hermetically Sealed Logic Reed Contact Blocks, page 19-92, Hermetically Sealed Power Reed Contact Blocks, page 19-92
 Light Modules: Standard Light Modules, page 19-91
 Knobs and Accessories: Additional Accessories for Type K and SK Operators, page 19-99

[93] When ordering, add prefix 9001 to the catalog number.
 [94] These operators can be ordered complete with contact blocks. Add the "H code" from Table 19.280 "H" Codes, page 19-93 as needed for your application.
 [95] ♦ Add the knob color code chosen from the Selector Switch Assembly Code table. For LED, knob color must match LED.
 [96] For other color knobs replace the B with knob color code. See Table 19.261 Selector Switch Assembly Code and Knob Cat. No., page 19-86.
 [97] ■ Add the voltage assembly code as chosen from Standard Light Modules, page 19-91. Example: K25J with 208Vac = K25J3
 [98] Add the knob color code. For LED, knob color must match LED.

9001SK 4-Position Selector Switches

Table 19.262: 4-Position Selector Switches

Contact Block Position	Contact Block Required				1 — Contact Closed 0 — Contact Open					
	Quantity and Type		Mount on Side		↙	↘	↗	↖		
<p>Top View</p>	KA1 	or	KA3 	KA1 #2	or	KA3 #2	1	0	0	0
			KA2 			KA2 #2	0	0	1	0
	KA1 	or	KA3 	KA1 #1	or	KA3 #1	0	0	0	1
			KA2 			KA2 #1	0	1	0	0
Cam (see Type K, KX, and SK Selector Switch Guide, page 19-78)								H		
Non-Illuminated Operators								Type [99]		
Manual Return [100], Operator Only (without contact blocks)										
Without Knob								SKS88		
With other Color Knob [101]								SKS88♦		
Illuminated Operators								Type [99]		
Manual Return [100], Operator Only (without contact blocks)										
Without Knob, 110-120V 50-60 Hz Transformer								SK88J1		
With Standard Red Knob, 110-120V 50-60 Hz Transformer								SK88J1R		
With other Color Knob [101] and other Voltage Light Module [102]								SK88J♦♦		

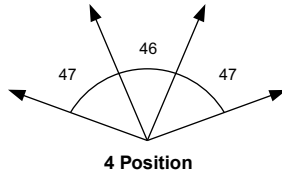

Table 19.263: Selector Switch Assembly Code and Knob Cat. No.

Color	Standard Knob		Gloved Hand Knob	
	[103] Knob Code	Cat. No. [99]	[103] Knob Code	Cat. No. [99]
Black	B	B11	FB	B25
Red	R	R8	FR	R24
Green	G	G8	FG	G24
Yellow	Y	Y8	FY	Y24
Blue	L	L8	FL	L24
White	W	W8	FW	W24
Amber	A	A8	FA	A24
Clear	C	C8	FC	C24

For Contact Blocks, see Contact Blocks, page 19-90, Hermetically Sealed Logic Reed Contact Blocks, page 19-92, Hermetically Sealed Power Reed Contact Blocks, page 19-92
For Light Modules, see Standard Light Modules, page 19-91
For Knobs and Accessories, see Additional Accessories for Type K and SK Operators, page 19-99

Potentiometers with Dial Plate

Table 19.264: Potentiometers with Dial Plate (not UL listed)—Maximum Voltage 300 Vac

Power	Description	Ratings	Type
2 W	Operator Only, for Single Potentiometer	NEMA 4, 13	SK20
	Operator with Single Potentiometer		SK21
	Operator Only, for Tandem Potentiometer		SK22
	Operator with Tandem Potentiometer		SK23

When ordering, add prefix 9001 to the catalog number.

Table 19.265: Potentiometer Suffixes

Single Potentiometer			
Suffix [104]	Resistance	Suffix [104]	Resistance
01	50 Ω	07	5 kΩ
02	100 Ω	08	10 kΩ
04	500 Ω	09	25 kΩ
05	1 kΩ	13	500 kΩ
39	2 kΩ	37	750 kΩ
06	2.5 kΩ	14	1 MΩ
Tandem Potentiometer			
Suffix [104]	Resistance		
	Front	Rear	
82	1 kΩ	1 kΩ	

NOTE: Any potentiometer with a shaft 7/8 in. long and 1/4 in. diameter may be used with these operators.

[99] When ordering, add prefix 9001 to the catalog number.

[100] These operators can be ordered complete with contact blocks. Add the "H" code from Table 19.280 "H" Codes, page 19-93 as needed for your application.

[101] ♦ Add the knob color code chosen from the Selector Switch Assembly Code table. For LED, knob color must match LED.

[102] ■ Add the voltage assembly code as chosen from Standard Light Modules, page 19-91. Example: K25J with 208Vac = K25J3

[103] Add the knob color code from Table 19.237. For LED, knob color must match LED

[104] For the complete part number, add the suffix from this table to the catalog number from Table 19.264 Potentiometers with Dial Plate, page 19-87. Example: 9001K2105.

Type SK Corrosion Resistant Pilot Lights

Table 19.266: Pilot Lights—UL Types 4, 4X, [105]



Description		Voltage	Style	With Red Fresnel Color Cap [106]	With Green Fresnel Color Cap [106]	With Other Color Cap [106] [107]	Without Color Cap [106]
	9001SKP1 Standard Pilot Light (Fresnel color cap shown)	110–120 V, 50–60 Hz	Transformer	SKP1R31	SKP1G31	SKP1■	SKP1
		220–240 V, 50–60 Hz	Transformer	SKP7R31	SKP7G31	SKP7■	SKP7
		24–28 Vac/Vdc	Full Voltage	SKP35R31	SKP35G31	SKP35■	SKP35
		For other voltages [106]	Transformer, Flashing or LED [108] Full Voltage, Neon or Resistor [109]	SKP▲R31 SKP▲G31	SKP▲G31 SKP▲G31	SKP▲■ SKP▲■	SKP▲ SKP▲
	9001SKT1 Push-To-Test Pilot Light (Fresnel color cap shown)	110–120 V, 50–60 Hz	Transformer	SKT1R31	SKT1G31	SKT1■	SKT1
		220–240 V, 50–60 Hz	Transformer	SKT7R31	SKT7G31	SKT7■	SKT7
		24–28 Vac/Vdc	Full Voltage	SKT35R31	SKT35G31	SKT35■	SKT35
		For other voltages [106]	Transformer, Flashing or LED [108] Full Voltage, Neon or Resistor [109]	SKT▲R31 SKT▲R31	SKT▲G31 SKT▲G31	SKT▲■ SKT▲■	SKT▲ SKT▲
	9001SKTR38 Remote Test Pilot Light (Fresnel color cap shown)	120 Vac Only	Resistor	SKTR38R31	SKTR38G31	SKTR38■	SKTR38
		24–28 Vac Only	Full Voltage	SKTR35R31	SKTR35G31	SKTR35■	SKTR35
		For other voltages [106] [107] [110]	Full Voltage or Resistor [111]	SKTR▲R31	SKTR▲G31	SKTR▲■	SKTR▲

Table 19.267: Color Caps

Color	Plastic Fresnel [112]	Plastic Domed [112]
Amber	A31	A9
Blue	L31	L9
Clear	C31	C9
Green	G31	G9
Red	R31	R9
White	W31	W9
Yellow	Y31	Y9



Typical Wiring Diagram

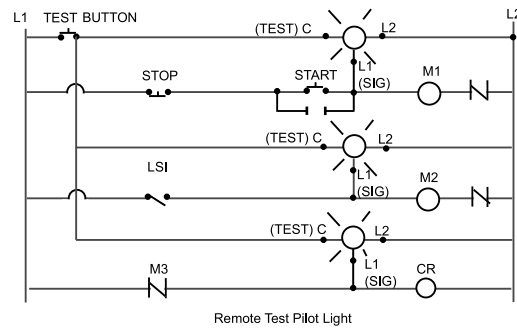
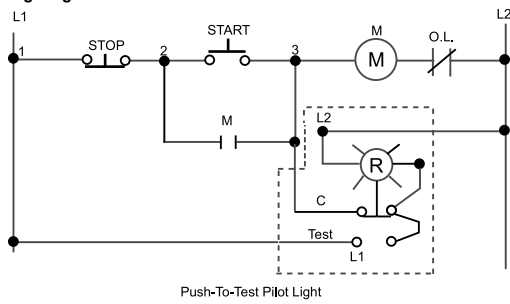

NOTE: To select and order Contact Blocks, Light Modules, Knobs, and Accessories, see Type KA Contact Blocks, page 19-90 through Hermetically Sealed Power Reed Contact Blocks, page 19-92.

NOTE: For use in hazardous locations—See Square D Offering According to Class, Division, and Group, page 19-92. Contact blocks and legend plate not included unless otherwise noted.

[105] When ordering, add prefix 9001 to the catalog number.

[106] ▲ Add the voltage assembly code as chosen from Standard and Shallow Depth Light Modules, page 19-91. **EXAMPLE:** SKT***R31 with 208 Vac red LED voltage = SKT37LRR31.

[107] ■ Add the color code as chosen from the color cap table below. **EXAMPLE:** SKP1 with a blue fresnel cap = SKP1L31.

[108] The cap must be the same color as the LED light module chosen, e.g., for a green LED, use a green color cap.

[109] On neon light modules, use clear color caps only.

[110] Use only full voltage or resistor voltage assembly codes on remote test pilot lights. Do not choose LED, neon or transformer codes. For AC use only.

[111] Use only full voltage or resistor voltage assembly codes on remote test pilot lights. Do not choose LED (exception — these LED codes are allowed: 38LG, 38LL, 38LR, 38LW, 38LY), neon or transformer codes. For AC use only.

[112] Add the color code as chosen from the color cap table below. **EXAMPLE:** SKP1 with a blue fresnel cap = SKP1L31.

Type SK Corrosion Resistant Multifunction Operators

Table 19.268: Multifunction Operators—UL Types 4, 4X, 13/NEMA 4, 4X, 13 [113][114]

Interlocked Assembly	Description	Color	Contacts [115]	Without Contacts [115]
 9001SKR11U	Interlocked Assembly Both Buttons Maintained	Universal [116]	SKR11UH1	SKR11U
		Other [117]	SKR11▼H1	SKR11▼
	Interlocked Assembly One Button Momentary	Universal [116]	SKR12UH1H1	SKR12U
	Interlocked Assembly One Button Maintained	Other [117]	SKR12▼H1H1	SKR12▼

[113] For use in hazardous locations—See Square D Offering According to Class, Division, and Group, page 19-92.

[114] Legend plate and contact block not included unless otherwise noted.

[115] When ordering, add prefix 9001 to the catalog number.

[116] Universal for SKR11,12 includes 2 each of black, red, green, yellow, orange, blue, white.

[117] ▼ Choose one color for each button. R = red, G = green, B = Black. **Example: 9001SKR11 with top button gray and bottom button orange = 9001SKR11ES.** See Table 19.253 Color Codes, page 19-83

Type KA Contact Blocks

The Class 9001 Type KA contact blocks are Fingersafe® contact blocks (meeting VDE 0106 Part 100). They have one screw mounting and captive (backed out) plus/minus terminal screws. These contact blocks are double-break, direct-acting contacts. Because of the wiping action of these contacts, they are suitable for use with programmable controllers. All contact blocks listed below accept up to 2 #12–#24 AWG solid or stranded wires. Recommended tightening torque for screw terminals is 7 lb-in.

Table 19.269: Standard Contact Blocks

Description	Symbol	Type
 (Clear Cover)	 Direct-Acting	KA1
 (Green Cover)		KA2
 (Red Cover)	 Direct-Acting	KA3
 (Clear Cover)	 N.O. Contact Early Closing	KA4
 (Red Cover)	 N.O. Contact Late Opening	KA5
 (Green Cover)	 N.O. Contact Early Closing	KA6

Symbol	Contact Blocks with Binder Head Screws (not Fingersafe)		Gold Flashed Contacts with Standard Pressure Wire Terminals
	Type [119]	Quantity [120]	Type [119]
	KA21	25–Up	KA31
	KA22	25–Up	KA32
	KA23	25–Up	KA33
 N.O. Early Closing	KA24	25–Up	KA34
 N.C. Contact Late Opening	KA25	25–Up	KA35

Contact blocks listed below are not Fingersafe, but provide:

- Terminals that accept ring tongue/fork tongue connectors
- Short single circuit contact blocks (0.75" deep vs. 0.97" deep on the Fingersafe)
- Same as old style Series G product available prior to March, 1989.
- For assembled operators, use form Y238 (add to catalog number as suffix, for example: 9001KRU1H13Y238)



Table 19.271: Contact blocks (not Fingersafe)

Symbol	Type [119]	Symbol	Type [119]
	KA1G	 N.O. Contact Early Closing	KA4G
	KA2G	 N.C. Contact Late Opening	KA5G
	KA3G	 N.O. Contact Early Closing	KA6G

Table 19.272: Contact blocks with Quick-Connect terminals (not Fingersafe)

Symbol	Type [119]
	KA12
	KA13

Table 19.270: Additional Circuit Arrangements

Description	Symbol	Type
Sequencing [118] N.O. Contact of KA4 closes before N.O. Contact on KA1	 KA4 KA1	Order One Type KA4 and One Type KA1
Overlapping [118] N.O. Contact of KA4 closes before N.C. Contact of KA5 Opens	 KA4 KA5	Order One Type KA4 and One Type KA5

Table 19.273: Maximum Current Ratings for Control Circuit Contacts—Types KA1–KA6, KA21–KA25, KA31–KA35, KA1G–KA6G

Volts	AC						Volts	DC				
	Inductive (NEMA / UL Type A600) 35% Power Factor					Resistive 75% Power Factor Make, Break and Continuous Amperes		Inductive and Resistive (NEMA Q600)				Continuous Carrying Capacity
	Make		Break		Continuous Carrying Amperes			Make and Break				
Amperes	VA	Amperes	VA			KA1	KA2 KA3	KA4	KA5 KA6			
120	60	7200	6.0	720	10	10	125	0.55	0.55	—	—	2.5
240	30		3.0				250	0.27	0.27	—	—	
480	15		1.5				600	0.10	0.10	—	—	
600	12		1.2									

[118] For push buttons or two-position selector switches only. For sequencing or overlapping contacts on other operators, refer to catalog 9001CT0001.

[119] When ordering, add prefix 9001 to the catalog number.

[120] Minimum order quantity is 25.

Standard and Shallow Depth Light Modules

Table 19.274: Standard Light Modules for Types K, SK, and KX Control Units [121][122][123][124]

	Voltage	Description	Light Module	Voltage Assembly Code	Rating	Replacement Lamp
			Type [125]			Part Number [121]
All		Full Voltage (without Bayonet Base Lamp)	KM40	40	—	None
6 Vac/Vdc		Full Voltage	KM31	31	.9 VA	2550101020
6 Vac/Vdc		LED Red	KM31LR	31LR		6508805201
6 Vac/Vdc		LED Green	KM31LG	31LG		6508805203
6 Vac/Vdc		LED Yellow	KM31LY	31LY		6508805202
12–14 Vac/Vdc		Full Voltage	KM32	32	1.2 VA	2550101037
12–14 Vac/Vdc		LED Red	KM32LR	32LR		6508805201
12–14 Vac/Vdc		LED Green	KM32LG	32LG		6508805203
12–14 Vac/Vdc		LED Yellow	KM32LY	32LY		6508805202
18 Vac/Vdc		Resistor	KM33	33	1.4 VA	2550101037
24–28 Vac/Vdc		Full Voltage	KM35	35	1.2 VA	2550101002
24–28 Vac/Vdc		LED Red	KM35LR	35LR	.28 VA	6508805210
24–28 Vac/Vdc		LED Green	KM35LG	35LG	.28 VA	6508805212
24–28 Vac/Vdc		LED Yellow	KM35LY	35LY	.28 VA	6508805211
24–28 Vac/Vdc		LED White	KM35LW	35LW	.28 VA	6508805214
24–28 Vac/Vdc		LED Blue	KM35LL	35LL	.28 VA	6508805213
48 Vac/Vdc		Full Voltage	KM36	36	2.6 VA	2550101025
110–120 V, 50–60 Hz		LED Red	KM1LR	1LR		6508805201
110–120 V, 50–60 Hz		LED Green	KM1LG	1LG		6508805203
110–120 V, 50–60 Hz		LED Yellow	KM1LY	1LY		6508805202
110–120 V, 50–60 Hz		Transformer	KM1	1	2.4 VA	2550101020
110–120 V, 50–60 Hz		Flashing	KMF1	F1	.85 VA	2550101036
120 Vac/Vdc		Full Voltage/Resistor	KM38	38	3.0 VA	2550101027
120 Vac/Vdc		Neon [126]	KM11	11	0.2 VA	2550101013
120 Vac/Vdc		LED Red	KM38LR	38LR	1.4 VA	6508805210
120 Vac/Vdc		LED Green	KM38LG	38LG	1.4 VA	6508805212
120 Vac/Vdc		LED Yellow	KM38LY	38LY	1.4 VA	6508805211
120 Vac/Vdc		LED White	KM38LW	38LW	1.4 VA	6508805214
120 Vac/Vdc		LED Blue	KM38LL	38LL	1.4 VA	6508805213
208–220 V, 50–60 Hz		Transformer	KM3	3	2.5 VA	2550101020
208–220 V, 50–60 Hz		LED Red	KM3LR	3LR		6508805201
208–220 V, 50–60 Hz		LED Green	KM3LG	3LG		6508805203
208–220 V, 50–60 Hz		LED Yellow	KM3LY	3LY		6508805202
208–220 V, 50–60 Hz		LED White	KM3LW	3LW		6508805215
208–220 V, 50–60 Hz		LED Blue	KM3LL	3LL		6508805216
220–240 V, 50–60 Hz		Transformer	KM7	7	2.0 VA	2550101020
220–240 V, 50–60 Hz		LED Red	KM7LR	7LR		6508805201
220–240 V, 50–60 Hz		LED Green	KM7LG	7LG		6508805203
220–240 V, 50–60 Hz		LED Yellow	KM7LY	7LY		6508805202
220–240 V, 50–60 Hz		LED White	KM7LW	7LW		6508805215
220–240 V, 50–60 Hz		LED Blue	KM7LL	7LL		6508805216
240 Vac/Vdc		Resistor	KM25	25	6.0 VA	2550101027
240 Vac/Vdc		Neon [126]	KM12	12	0.3 VA	2550101013
277 V, 50–60 Hz		Transformer	KM8	8	2.4 VA	2550101020
380–480 V, 50–60 Hz		Transformer	KM5	5	2.8 VA	2550101020
480 Vac/Vdc		Neon [126]	KM14	14	0.5 VA	2550101013
550–600 V, 50–60 Hz		Transformer	KM6	6	2.5 VA	2550101020

NOTE: Light modules are available in other voltages. For additional information, refer to Catalog 9001CT0001.

Table 19.275: Shallow Depth Light Modules For Types K and SK Control Units [121] [123] [127] [122]

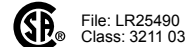

	Voltage	Description	Light Module	Voltage Assembly Code	Rating	Replacement Lamp
			Type [125]			Part Number
24–28 Vac/Vdc		Full Voltage	KM55	55	1.2 VA	2550101002
		LED Red	KM55LR	55LR	0.5 VA	6508805204
		LED Green	KM55LG	55LG		6508805206
110–120 Vac/Vdc		LED Yellow	KM55LY	55LY		6508805205
		Full Voltage	KM58	58	3.0 VA	2550101027
		LED Red	KM58LR	58LR	0.5 VA	6508805204
LED Green	KM58LG	58LG	6508805206			
		LED Yellow	KM58LY	58LY		6508805205



[121] For use with all operators except KX and remote test pilot.
 [122] For use in hazardous locations—See Square D Offering According to Class, Division, and Group, page 19-92.
 [123] With LED light modules, use either a clear color cap or a cap the same color as the LED.
 [124] With neon type light modules, use a clear color cap only.
 [125] When ordering, add prefix 9001 to the catalog number.
 [126] Not for use on KX operators.
 [127] Reduces the depth of illuminated push buttons with contact blocks by over 33%.

Hazardous locations do not always require the use of explosion-proof equipment like the Class 9001 Type BR control stations. Selecting the most appropriate device for the location can save you money. For more information on the types of hazardous locations, contact your local electrical inspector.

Table 19.276: Hazardous Locations

Types K, SK  File: E10054 (N) CCN: NOIV  File: LR26817 Class: 3218 02

Square D Offering According to Class, Division, and Group

Table 19.277: Square D Offering According to Class, Division, and Group

For			Use
Class	Division	Group(s)	
I	1	A	1. Intrinsically Safe System
I	1	B, C, D	1. 9001 BR station
			2. Intrinsically Safe System
I	2	A	1. 9001 K, SK, KX control stations with restrictions [128] [129]
			2. Intrinsically Safe System
I	2	B, C, D	1. 9001 BR station
			2. 9001 K, SK, KX control stations with restrictions [128] [129]
			3. Intrinsically Safe System
II	1	E, F, G	1. 9001 BR station
			2. Intrinsically Safe System
II	2	E, F	1. 9001 BR station
			2. 9001 K, SK, KX control stations with restrictions [128] [129]
			3. Intrinsically Safe System
II	2	G	1. 9001 BR station
			2. 9001 K, SK, KX control stations with restrictions [130] [129]
			3. Intrinsically Safe System
III	1, 2	—	1. 9001 BR Station
			2. 9001 K, SK, KX control stations with restrictions [130] [129]
			3. Intrinsically Safe System

Hermetically Sealed Logic Reed Contact Blocks

Table 19.278: Hermetically Sealed Logic Reed Contact Blocks [131] [132]

Suitable for use on low energy level circuits



Description	Symbol	Type [133]
The maximum number of logic and/or power reed contact blocks per operator is as indicated on individual selection tables for standard contact blocks, except : <ul style="list-style-type: none"> On 3 position selector switches with cams C, D, E, F, G, L, or M, mount reed blocks on one side only (either side), maximum 2 in tandem. On 4 position selector switches, mount reed blocks on one side only (either side), maximum 2 in tandem. On joysticks or on Type KR8 or SKR8 push-pull operators, mount reed blocks on one side only (either side), maximum 2 in tandem. 		KA41
		KA42
		KA43
		KA44
		KA45

Max. Vac/Vdc	Maximum Load		
	Resistive	Inductive	Continuous
32/30	.25 A	.10 A	.5 A
120/100	8 VA	3 VA	.5 A

Hermetically Sealed Power Reed Contact Blocks

Table 19.279: Hermetically Sealed Power Reed Contact Blocks [131] [132] [134]



Description	Symbol	Type [133]
The maximum number of logic and/or power reed contact blocks per operator is as indicated on individual selection tables for standard contact blocks, except : <ul style="list-style-type: none"> On 3 position selector switches with cams C, D, E, F, G, L, or M, mount reed blocks on one side only (either side), maximum 2 in tandem. On 4 position selector switches, mount reed blocks on one side only (either side), maximum 2 in tandem. On joysticks or on Type KR8 or SKR8 push-pull operators, mount reed blocks on one side only (either side), maximum 2 in tandem. 		KA51
		KA52
		KA53
		KA54
		KA55

Volts	Make		Break		Continuous
	A	VA	A	VA	
AC NEMA C300 [135]					
120	10.00	1200	1.000	120	3.0
240	5.00		.500		
DC NEMA Q150 [136]					
115	.50	58	.50	58	3.0

[128] Any Class 9001 Type K, SK or KX operator can be used in an area classified as Class I, Division 2 hazardous locations, if:

- Only logic (KA40 series) or power (KA50 series) reed contact blocks are used.
- All Type K and SK illuminated operators are UL approved for use in Class I Division 2 areas. (Add Form Y243 to single lamp Push-To-Test pilot lights.)
- Type KX illuminated operators do not use 4 lamp light modules, or 2 lamp light modules other than the transformer type. (Add Form Y243 to single lamp Push-To-Test pilot lights.)
- The operators are mounted in any NEMA 4 & 13 enclosures.

[129] UL Listed: File E10054(N), CCN NOIV.

[130] Any Class 9001 Type K, SK, or KX operator mounted in a Class 9001 Type KY, KYSS, KYAF, SKY enclosure may be used, except potentiometer operators.

[131] Not for use in pendant stations.

[132] When ordering, add prefix 9001 to the catalog number.

[133] All contact blocks listed below accept #12–18 solid or stranded wire.

[134] The power reed contact blocks can be used with standard industrial relays and starters through NEMA Size 4. Minimum voltage is 5 V and the minimum current is 1 mA.

[135] Inductive Rating—35% Power Factor.

[136] Inductive and Resistive Ratings

Type K, SK, and KX Contact Block "H" Numbers

The design of Class 9001 Type KA contact blocks allows them to be mounted side by side and/or in tandem. This enables you to specify an operator and a specific arrangement of contact blocks (shipped fully assembled) with a single Type number.

Table 19.280: "H" Codes

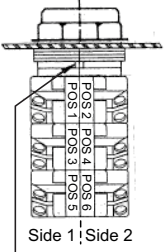
Suffix No. (Add to Operator Type)	Positions					
	1	2	3	4	5	6
Example: A Type KR1B push button with 2 Type KA1 contact blocks would be Class 9001 Type KR1BH2.	H1 H2 H3 H4	KA1 KA1 KA1 KA1	KA1 KA1 KA1		KA1 KA1	
	H5 H6 H7 H8	KA2 KA3 KA2 KA3	KA2 KA3			
	H9 H10 H11 H12	KA4 KA4 KA1 KA2	KA1 KA5 KA1 KA3		KA1 KA3	
	H13 H14 H15 H16		KA1 KA3 KA3 KA3	KA2	KA3	
	H17 H18 H19 H21	KA1 KA3 KA1 KA2	KA1 KA1 KA3 KA1	KA2	KA1	KA3 KA1
	H23 H24 H25	KA1 KA1 KA5	KA1 KA2 KA3	KA1	KA1	KA1 KA1

NOTE: For "H" Codes not in this table, contact your local Schneider Electric Customer Care Center.

Mounting Hole for All Types K, SK, and KX Control Units

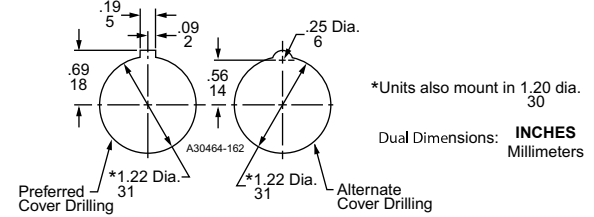

*Units also mount in 1.20 dia. 30
Dual Dimensions: INCHES
Millimeters

Hole Punch: Use Greenlee Tool #60242 to punch mounting hole and notch.

Maximum Contact Block Usage (Includes Types K, SK and KX)

- **2 blocks mounted side by side only:** Any 2, 3 or 4 position spring return selector switch (non-illuminated, illuminated or keyed).
- **2 blocks mounted in tandem 1 side only:** Any 2 operator interlocked push button.
- **2 blocks mounted in tandem (total of four blocks):** Any selector push button, keyed push button, 2, 3, or 4 position maintained selector switch (non-illuminated, illuminated or keyed), push-pull operators (non-illuminated or illuminated), joy stick, dual push button.
- **3 blocks mounted in tandem (total of six blocks):** Single momentary push buttons (non-illuminated or illuminated).

Table 19.281: Dimensions When Using Contact Blocks

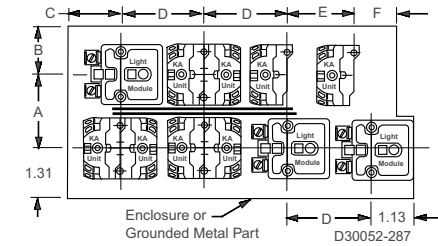
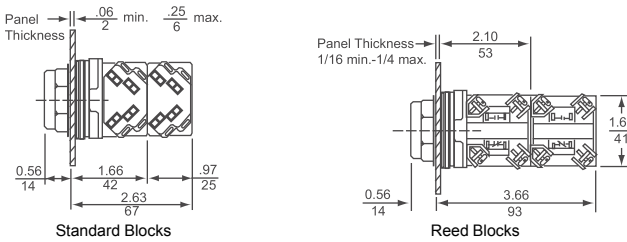

Table 19.282: Basic Operators (Without Color Caps, Mushroom Buttons, Knobs, Selector Switch Cams, Contact Blocks, Light Modules, or Legend Plates)

Description	For UL Types/NEMA	
	1, 3R, 4, 12, 13 [137]	4, 4X, 13 [137]
Non-Illuminated Push Button (Extended Guard)	KR2	SKR2
Non-Illuminated Push Button (No Guard)	KR3	SKR3
Non-Illuminated Push Button (Mushroom Button/Screw-On)	KR20	SKR20
Non-Illuminated Dual Push Button (Momentary)	KR6	—
Non-Illuminated Dual Push Button (Momentary Interlocked)	KR67	—
Non-Illuminated Dual Push Button (Maintained Interlocked)	KR7	—
Momentary Pull—Maintained Neutral—Momentary Push	KR8 [138] [139]	SKR8 [138]
Maintained Pull—Maintained Push	KR9 [138] [139]	SKR9 [138]
Illuminated Push Button (Full Guard—Plastic Top)	K1L [140]	SK1L [140]
Illuminated Push Button and Push-To-Test (No Guard)	K2L [140] [141]	SK2L [140] [141]
Illuminated Push Button (Full Guard—Metal Top)	K3L [140]	—
Standard Pilot Light	KP	SKP
3 Position Maintained Selector Switch	KS4 [138]	SKS4 [138]
3 Position Spring Return Both Sides To Center—Selector Switch	KS5 [138]	SKS5 [138]
3 Position Spring Return Left To Center—Selector Switch	KS6 [138]	SKS6 [138]
3 Position Spring Return Right To Center—Selector Switch	KS7 [138]	SKS7 [138]

Table 19.283: Min. Centerline Spacing, Type K & SK Control Units

Legend Plate	Operator	Centerline Spacing (in.)					
		A	B	C	D	E	F
Legend Plate Orientation Position #1							
KN2	Standard Push Button	1.75	1.31	1.44	2.25	1.69	0.88
	1.375 in. Dia. Mushroom	1.75	1.31	1.44	2.25	1.69	0.88
KN5	2.25 in. Dia. Mushroom	2.25	1.31	1.44	2.25	2.25	1.12
	Selector Switch Knobs	1.75	1.31	1.44	2.25	1.69	0.88
KN3	Standard Push Button	2.00	1.31	1.44	2.25	1.75	0.88
	1.375 in. Dia. Mushroom	2.00	1.31	1.44	2.25	1.75	0.88
KN4	2.25 in. Dia. Mushroom	2.25	1.31	1.44	2.25	2.25	1.12
	Selector Switch Knobs	2.00	1.31	1.44	2.25	1.75	0.88
KN6	Standard Push Button	2.38	1.62	1.44	2.25	2.25	1.12
	1.375 in. Dia. Mushroom	2.38	1.62	1.44	2.25	2.25	1.12
KN3	2.25 in. Dia. Mushroom	2.38	1.62	1.44	2.25	2.25	1.12
	Selector Switch Knobs	2.38	1.62	1.44	2.25	2.25	1.12
Legend Plate Orientation Position #2							
KN2	Standard Push Button	1.62	1.31	1.44	2.25	1.75	0.88
	1.375 in. Dia. Mushroom	1.62	1.31	1.44	2.25	1.75	0.88
KN5	2.25 in. Dia. Mushroom	2.25	1.31	1.44	2.25	2.25	1.12
	Selector Switch Knobs	1.62	1.31	1.44	2.25	1.75	0.88
KN3	Standard Push Button	1.75	1.31	1.44	2.25	2.00	0.88
	1.375 in. Dia. Mushroom	1.75	1.31	1.44	2.25	2.00	0.88
KN4	2.25 in. Dia. Mushroom	2.25	1.31	1.44	2.25	2.25	1.12
	Selector Switch Knobs	1.75	1.31	1.44	2.25	2.00	0.88
KN6	Standard Push Button	1.62	1.31	1.44	2.25	1.94	1.00
	1.375 in. Dia. Mushroom	1.62	1.31	1.44	2.25	1.94	1.00
KN3	2.25 in. Dia. Mushroom	2.25	1.31	1.44	2.25	2.25	1.12
	Selector Switch Knobs	1.62	1.31	1.44	2.25	1.94	1.00
KN4	Standard Push Button	1.62	1.31	1.44	2.25	1.94	1.00
	1.375 in. Dia. Mushroom	1.62	1.31	1.44	2.25	1.94	1.00
KN6	2.25 in. Dia. Mushroom	2.25	1.31	1.62	2.38	2.38	0.88
	Selector Switch Knobs	2.25	1.31	1.62	2.38	2.38	0.88
KN5	2.25 in. Dia. Mushroom	2.25	1.31	1.62	2.38	2.38	0.88
	Selector Switch Knobs	2.25	1.31	1.62	2.38	2.38	0.88

[137] When ordering, add prefix 9001 to the catalog number.

[138] Operator can be converted to an illuminated operator by removing the liner (6512240601) and adding a light module.

[139] These operators can be supplied with 1-3/8 in. or 2-1/4 in. dia. mushroom buttons. For 1-3/8 in.: add () 20 to type number. For 2-1/4 in.: Add () 21 to type number. The () refers to the color chosen—see Additional Accessories for Type K and SK Operators, page 19-99. Voids UL and NEMA 6 Rating.

[140] Operator can be converted to a non-illuminated operator by adding liner (6512240601).

[141] Operator includes jumper wires for push-to-test conversion.

Table 19.285: Legend Plates—Special Marking

Legend Plate	Description	Type [145]	
KN100()P (Plastic) [146] 2.25 in. Square	Standard Markings	See Table 19.284 Legend Plates, page 19-94	
	Special Marking [147]	Silver Field, Black Letters	KN199SP
		White Field, Black Letters	KN199WP
		Red Field, Black Letters	KN199RP
		Black Field, White Letters	KN199BP
KN200 Aluminum	Standard Markings	See Table 19.284 Legend Plates, page 19-94	
	Special Marking [147]	Black Field	KN299
		Red Field	KN299R
KN200()P (Plastic) [146] 1.7 in. Square	Standard Markings	See Table 19.284 Legend Plates, page 19-94	
	Special Marking [147]	Silver Field, Black Letters	KN299SP
		White Field, Black Letters	KN299WP
		Red Field, Black Letters	KN299RP
		Black Field, White Letters	KN299BP
KN300 Aluminum	Standard Markings	See Table 19.284 Legend Plates, page 19-94	
	Special Marking [147]	Black Field	KN399
		Red Field	KN399R
KN400 Aluminum	Blank	KN400	
	Any Marking [147]	KN499	
KN500 Aluminum	Standard Markings	Select from Table 19.290 Special Legend Plates, page 19-96	
	Special Marking [147]	Black Field	KN599
		Green Red Field	KN519
KN600 Aluminum	Blank	KN600	
	Any Marking [147]	Black Field	KN600R
		Red Field	KN699
		Black Field	KN699R
		Red Field	KN699R
KN700()P (Plastic) [146] 2.5 in. Square	Standard Markings	Select from Table 19.284 Legend Plates, page 19-94	
	Special Marking [147]	Silver Field, Black Letters	KN799SP
		White Field, Black Letters	KN799WP
		Red Field, Black Letters	KN799RP
		Black Field, White Letters	KN799BP
KN800 Aluminum	Standard Markings	Select from Table 19.284 Legend Plates, page 19-94	
	Special Marking [147]	Blue Field	KN899
		Red Field	KN899R
KN900 Aluminum	Blank	KN900	
	Any Marking [147]	KN999	

Table 19.286: Maximum Number of Lines and Characters for Type KN Legend Plates

Type	KN100	KN200	KN300	KN400	KN500	KN600	KN700	KN800	KN900
Max. No. of Characters per Line	16	14	18	18	8 per field	22	17	18	18 per pos.
Max. No. of Lines	2	1	3	2	2 per field	4	2	2	1 per pos.

NOTE: The maximum number of characters and lines is a practical maximum, based on a minimum size of characters to facilitate easy reading.

Table 19.287: Circular Legends for Emergency Stop Mushroom Heads (yellow background)

Diameter	Text	Catalog Number [145]
60 mm	—	9001KN9100
	EMERGENCY STOP	9001KN9330
90 mm	—	9001KN8100
	EMERGENCY STOP	9001KN8330

Table 19.288: Plastic Legend Plates—Other Colors



	Plate Color	Letter Color	1.7 in. Square [145]	2.25 in. Square [145]	2.5 in. Square [145]
Blank Legend Plates	Yellow	Black	KN200YP	KN100YP	KN700YP
	Green	White	KN200GP	KN100GP	KN700GP
	Blue		KN200LP	KN100LP	KN700LP
	Red		KN200CP	KN100CP	KN700CP
Special Engraved Legend Plates	Yellow	Black	KN299YP	KN199YP	KN799YP
	Green	White	KN299GP	KN199GP	KN799GP
	Blue		KN299LP	KN199LP	KN799LP
	Red		KN299CP	KN199CP	KN799CP

[145] When ordering, add prefix 9001 to the catalog number.

[146] Other colors available (see Table 19.288 Plastic Legend Plates—Other Colors, page 19-95).

[147] Specify marking required.

Table 19.289: Min. Centerline Spacing, Type K & SK Control Units

Legend Plate		Operator	Centerline Spacing (in.)					
			A	B	C	D	E	F
Legend Plate Orientation Position #1								
 Legend Plate Position #1	KN2 KN5	Standard Push Button	1.75	1.31	1.44	2.25	1.69	0.88
		1.375 in. Dia. Mushroom	1.75	1.31	1.44	2.25	1.69	0.88
		2.25 in. Dia. Mushroom	2.25	1.31	1.44	2.25	2.25	1.12
		Selector Switch Knobs	1.75	1.31	1.44	2.25	1.69	0.88
	KN3	Standard Push Button	2.00	1.31	1.44	2.25	1.75	0.88
		1.375 in. Dia. Mushroom	2.00	1.31	1.44	2.25	1.75	0.88
		2.25 in. Dia. Mushroom	2.25	1.31	1.44	2.25	2.25	1.12
		Selector Switch Knobs	2.00	1.31	1.44	2.25	1.75	0.88
	KN4	Standard Push Button	1.94	1.31	1.44	2.25	1.62	0.88
		1.375 in. Dia. Mushroom	1.94	1.31	1.44	2.25	1.62	0.88
		2.25 in. Dia. Mushroom	2.25	1.31	1.44	2.25	2.25	1.12
		Selector Switch Knobs	1.74	1.31	1.44	2.25	1.62	0.88
	KN6	Standard Push Button	2.38	1.62	1.44	2.25	2.25	1.12
		1.375 in. Dia. Mushroom	2.38	1.62	1.44	2.25	2.25	1.12
		2.25 in. Dia. Mushroom	2.38	1.62	1.44	2.25	2.25	1.12
		Selector Switch Knobs	2.38	1.62	1.44	2.25	2.25	1.12
Legend Plate Orientation Position #2								
 Legend Plate Position #2	KN2 KN5	Standard Push Button	1.62	1.31	1.44	2.25	1.75	0.88
		1.375 in. Dia. Mushroom	1.62	1.31	1.44	2.25	1.75	0.88
		2.25 in. Dia. Mushroom	2.25	1.31	1.44	2.25	2.25	1.12
		Selector Switch Knobs	1.62	1.31	1.44	2.25	1.75	0.88
	KN3	Standard Push Button	1.75	1.31	1.44	2.25	2.00	0.88
		1.375 in. Dia. Mushroom	1.75	1.31	1.44	2.25	2.00	0.88
		2.25 in. Dia. Mushroom	2.25	1.31	1.44	2.25	2.25	1.12
		Selector Switch Knobs	1.75	1.31	1.44	2.25	2.00	0.88
	KN4	Standard Push Button	1.62	1.31	1.44	2.25	1.94	1.00
		1.375 in. Dia. Mushroom	1.62	1.31	1.44	2.25	1.94	1.00
		2.25 in. Dia. Mushroom	2.25	1.31	1.44	2.25	2.25	1.12
		Selector Switch Knobs	1.62	1.31	1.44	2.25	1.94	1.00
	KN6	Standard Push Button	2.25	1.31	1.62	2.38	2.38	0.88
		1.375 in. Dia. Mushroom	2.25	1.31	1.62	2.38	2.38	0.88
		2.25 in. Dia. Mushroom	2.25	1.31	1.62	2.38	2.38	1.12
		Selector Switch Knobs	2.25	1.31	1.62	2.38	2.38	0.88



Special Legend Plates

Table 19.290: Special Legend Plates

Type	Type KN500 (For Use with Dual Function Operators: KR6, KR7 and KR67)	
	Standard Markings	
	Green	Red
KN500	Blank	Blank
KN501	Start	Stop
KN502	On	Off
Type	Black	Black
KN520	Blank	Blank
KN521	Start	Stop
KN522	On	Off
KN523	Forward	Reverse
KN524	Up	Down
KN525	High	Low
KN526	Open	Close

Padlock Attachments for Type K and SK Operators

Table 19.291: Padlock Attachments



Used On	Description	Type [148]
Type K non-illuminated push button — Standard or mushroom (KR4, KR5 mushroom buttons only).	Holds button in depressed position and can be padlocked.	K4
Types K and SK non-illuminated push buttons with or without protective boots.	Holds button in depressed position when padlocked.	K5 K97
Types K and SK non-illuminated push buttons, cover type attachment. KR, SKR	Attachment can be padlocked. Does not hold button in depressed position.	K6
Types K and SK push buttons, cover type attachment.	Spring loaded cover cannot be padlocked. Does not hold button in depressed position.	K60
Types K and SK push-pull operator and illuminated push buttons. KR8, KR9	Holds button in depressed position and can be padlocked.	K62
KR11U and KR12U Interlocked Assembly	Holds maintained button in depressed position and can be padlocked.	K96
Type KR9 & SKR9 Push-Pull operators—Non-Illuminated and Illuminated	Holds button in depressed position. Can be padlocked.	K162

Table 19.292: Padlock Attachments

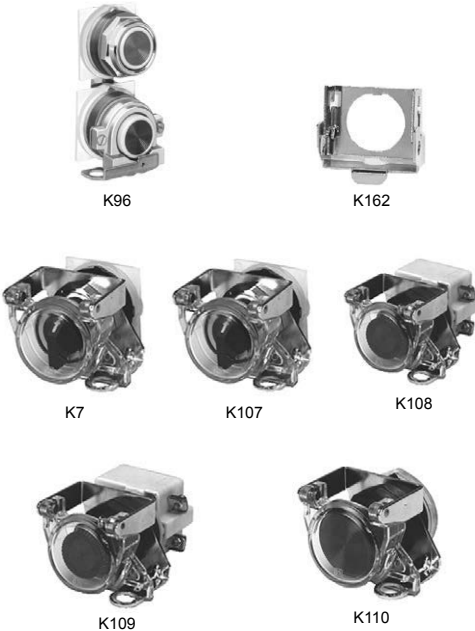

Used On	Description	Type [148]
Types K and SK selector switches and potentiometers (will not work with gloved-hand knob).	Cover type attachment that can be padlocked to keep unauthorized personnel from tampering with the operator.	K7
Types K and SK selector switches and potentiometers (will not work with gloved-hand knob).	Same as 9001K7 but with spring loaded lockout cover.	K107
Types K and SK illuminated push buttons (with or without guard) and key operated push buttons.	Cover type attachment that can be padlocked to keep unauthorized personnel from tampering with the operator.	K108
Types K and SK illuminated push buttons (with or without guard) and key operated push buttons.	Same as 9001K108 but with spring loaded lockout cover.	K109
Types K and SK maintained push-pull operators using 1.375 in. dia. mushroom buttons (<20 series, see Additional Accessories for Type K and SK Operators, page 19-99).	Cover type attachment that holds mushroom button in depressed position and can be padlocked.	K110

Mushroom Button Guards for Type K and SK Operators

Table 19.293: Mushroom Button Guards



Description	Used On	Type [149] [150] [151]
Aluminum Mushroom Guard for 1.375 in. Mushroom Button Operator (KR4, KR24)	KR4, KR24	K48
Yellow Plastic Extended Mushroom Guard for 1.375 in. and 1.625 in. Mushroom Button Operators	KR4, SKR4	K56■
	KR8, KR9, SKR8, SKR9	K56♦M▲
Aluminum Mushroom Guard for 2.25 in. Mushroom Button Operator	KR5	K68
	KR25	K685

[148] When ordering, add prefix 9001 to the catalog number.
 [149] ■ B=Black G=Green R=Red Y=Yellow
 [150] ♦ R=Red Y=Yellow
 [151] ▲ The mushroom guard has finger holes for push-pull operators.

Protective Boots for Type K and SK Operators

Table 19.294: Protective Boots



For Non-Illuminated Push Buttons [152]		Clear Color for	Type [153]
Color	Type [153]		
Black	KU1	Standard knob selector switch	KU17
Red	KU2		
Blue	KU3		
Brown	KU4	Gloved-hand cap for use on standard knob selector switch	KU18
Green	KU5		
Yellow	KU6	Standard pilot light and maintained contact push buttons	KU27
Clear	KU7		
Clear	KU8		
(Provides Full Guard)		Illuminated push button with guard	KU47

NOTE: These Type KU protective boots are recommended for very dirty environments or severe hose down, but they are not required for UL Type 4 rating on the Type K operators or UL Type 4 or 4X rating on the Type SK operators. The K1 wrench (see Wrenches for Type K and SK Operators, page 19-101) is required for installation of these boots.

Closing Plates for Type K and SK Operators

Table 19.295: Closing Plates

 Round (1-1/2 in. Dia.)	Description	Type
	Gray	K51 [154]
Black	K52 [154]	

For Dimensions, see catalog 9001CT0001

[152] Use KU27 for maintained contact push buttons.
 [153] When ordering, add prefix 9001 to the catalog number.
 [154] Meets UL and NEMA 1, 2, 3, 4, 4X, 6, 12 and 13.

Ring Nuts for Type K and SK Operators

Table 19.298: Ring Nuts

Used On	Type [166]	Used On	Type [166]
K1L	K44	SK1L	SK44
K30-K37	K45	—	—
K70-K73	K45	—	—
K20, K21, K22, K23	K45	SK20, SK21, SK22, SK23	SK45
K20, K21, K22, K23 [167]	SK46	SK20, SK21, SK22, SK23 [167]	SK46
K2L	K49	SK2L	SK49
K3L (complete)	K111	—	—
K3L (metal top only)	6515802701	—	—
KP, KTR	K41	SKP, SKTR	SK41
KR1	K41	SKR1	SK41
KR11	K42	SKR11	SK42
KR12 [168]	K42	SKR12 [168]	SK42
KR12 [169]	K41	SKR12 [169]	SK41
KR13, 14, 15	K55	—	—
KR2	K42	SKR2	SK42
KR20	K49	—	—
KR24	K49	—	—
KR25	K49	SKR25	SK49
KR3	K40	SKR3	SK40
KR4	K41	SKR4	SK41
KR5	K41	SKR5	SK41
KR6	K47	—	—
KR67	K47	—	—
KR7	K47	—	—
KR8	K58	SKR8	6509704401
KR9	K41	SKR9	SK41
KS	K45	SKS	SK45
KS [167]	SK46	SKS [167] SKRU11 SKRU1,2,3,4,5,10	SK46 SK41 SK40
KT	K49	SKT	SK49

Replacement and Repair Parts for Type K and SK Operators

Table 19.299: Replacement Lamps For Series A–F (black) Light Modules

Light Module Type	Lamp Number (ANSI)	Square D Replacement Lamps
		Part Number
KM1	GE44[170]	—
KM2	GE1490	2550101003
KM3	GE44[170]	—
KM4	GE1490	2550101003
KM5	GE44[170]	—
KM6	GE44[170]	—
KM7	GE44[170]	—
KM8	GE44[170]	—
KM9	GE755	2550101020
KM11	CMDK1A5	2550105014
KM12	CMDK1A5	2550105014
KM13	CMDK1A5	2550105014
KM14	CMDK1A5	2550105014
KM15	CMDK1A5	2550105014
KM21	SYL12PSB	2550105003
KM22	SYL12PSB	2550105003
KM23	SYL28PSB	2550105008
KM25	SYL120PSB	2550105005
KM31	SYL6PSB	2550105007
KM32	SYL12PSB	2550105003
KM34	SYL24PSB	2550105004
KM35	SYL28PSB	2550105008
KM36	SYL48PSB	2550105009
KM37	SYL60PSB	2550105010
KM38	SYL120PSB	2550105005

Table 19.300: Repair Parts

Description	Part Number
E10 Key	2941101100
Gray cap for KR11, KR12, SKR11, or SKR12	3105217001
Clear plastic top (only) for 9001K44 & SK44 Ring Nut)	4487D63XI
Gasket for Type K and SK Push-Pull Knob	6509701801
Gasket for Plastic Illuminated Lens	6509701901
Gasket for Type K and SK selector switch knob	3105406401
Black Compensating Gasket (Type K and SK Operators)	6509702001
Liner for Non-Illuminated Operators	6509704901
Locking Thrust Washer	6512231201
Nylon Spacer	6509705001
Locking Thrust Washer (Std. Type SK Operator)	6512240601
Push-Pull Mushroom Adapter [171]	K54
Rubber Boot for Joystick	6512243201
Knob on Joysticks without latch	4458D20X3
Knob for SK Potentiometer	3105404408
Fingersafe™ Cover for 9001KM	6508804101

Table 19.301: KU Replacement Ring Nuts (Threaded Inside and Out)

Used On	Part Number
KU1 through KU8, KU27, KU37, KU47	3105204101
KU17, KU18	3105205901

[166] When ordering, add prefix 9001 to the catalog number.

[167] Secondary ring nut (holds knob on selector switch or potentiometer).

[168] Maintained button of two button operator.

[169] Momentary button of two button operator.

[170] GE44 and GE755 are interchangeable (GE755 gives longer life). If a GE44 lamp is ordered, a GE755 (2550101020) will be substituted. For a replacement lamp in a current series light module, see *Standard and Shallow Depth Light Modules*, page 19-91.

[171] Allows Type -20 and -21 mushroom color caps to be used on push-pull operators. Use of 9001K54 voids Type 6 rating.



K3



K69



K95



K1

Interlock for Type K and SK Operators

For mechanically interlocking two push buttons so that only one button can be depressed at a time. A Type K3 attachment is furnished with the **9001 KR11, KR12, SKR11, SKR12, SKRU1** and **SKRU11** operators. However, these are maintained operators and the **K3** interlock serves to release one of the buttons when the other is depressed. When used with momentary contact buttons, the **K3** interlock **does not** hold the buttons in the depressed position. It simply prevents pushing both buttons at the same time.

Table 19.302: Interlock

Description	Type
The Type K3 interlock is mounted behind the operators. Operators not included.	K3

NOTE: When ordering, add prefix 9001 to the catalog number.

Screwdriver for Type K and SK Operators

Table 19.303: Screwdriver

Description	Type
Used to tighten mounting screws on contact blocks and light modules.	K69

NOTE: When ordering, add prefix 9001 to the catalog number.

Wrenches for Type K and SK Operators

Table 19.304: Wrenches

Where Used	Type
For tightening ring nuts on 22 and 30 mm control units	K95
For tightening threaded protective caps	K1

NOTE: When ordering, add prefix 9001 to the catalog number.

KX Square Push Buttons with Contacts

Table 19.305: Push Buttons—Single, with Contacts



Description	Button Color	Legend Marking	Contacts	Voltage	Type [1]
Non-Illuminated	Green	Start	1 N.O.	—	KXRA133
	Red	Stop	1 N.C.	—	KXRA134
	Amber	blank	2 N.O., 2 N.C.	—	KXRAAH2
	Green	blank	2 N.O., 2 N.C.	—	KXRAGH2
	Blue	blank	2 N.O., 2 N.C.	—	KXRALH2
Illuminated	Amber	blank	1 N.O., 1 N.C.	24	KXRB34AH1
	Green	blank	1 N.O., 1 N.C.	24	KXRB34GH1
	Red	blank	1 N.O., 1 N.C.	24	KXRB34RH1
	Amber	blank	1 N.O., 1 N.C.	110/120	KXRB1AH1
	Green	blank	1 N.O., 1 N.C.	110/120	KXRB1GH1
	Red	blank	1 N.O., 1 N.C.	110/120	KXRB1RH1

Table 19.306: Push Buttons—Dual, with Contacts



Description	Top Button (#1)	Lower Button (#2)	Contacts	Type [1]
Momentary	Start (Green)	Stop (Red)	2 N.O., 2 N.C.	KXRC111
Momentary	Start (Green)	Stop (Red)	1 N/O, 1 N/C	KXRC136
Momentary	Up (Green)	Down (Green)	2 N.O.	KXRD140
Momentary	blank (Blue)	blank (Blue)	2 N.O.	KXRDLH7
Maintained [2]	Start (Green)	Stop (Red)	1 N.O., 1 N.C.	KXRE115
Maintained [2]	On (Blue) [3]	Off (Blue) [3]	3 N.O., 3 N.C.	KXRELLH3
Maintained [2]	On (Blue) [3]	Off (Blue) [3]	3 N.O., 3 N.C.	KXRELLH3
Maintained [2]	On (Blue) [3]	Off (Blue) [3]	2 N.O., 2 N.C.	KXRELLH2

Table 19.307: Push Buttons—Dual with One Pilot Light and Contacts

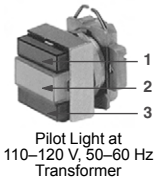

Description	Top Button (#1)	Middle Lens (#2)	Lower Button (#3)	Contacts	Voltage	Type [1]
Momentary	Start (Green)	On (Red)	Stop (Red)	2 N.O., 2 N.C.	110/120	KXRG117
Momentary	Start (Green)	On (Red)	Stop (Red)	1 N.O., 1 N.C.	110/120	KXRG137
Maintained [2]	Start (Green)	On (Red)	Stop (Red)	1 N.O., 1 N.C.	110/120	KXRJ119

Table 19.308: Push Buttons—Dual with Two Pilot Lights and Contacts

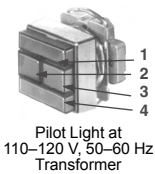

Description	Top Button (#1)	Left Lens (#2)	Right Lens (#3)	Lower Button (#4)	Contacts	Voltage	Type [1]
Momentary	Start (Green)	On (Red)	Off (Green)	Stop (Red)	2 N.C., 2 N.C.	110/120	KXRL121
Momentary	Start (Green)	On (Red)	Off (Green)	Stop (Red)	1 N.O., 1 N.C.	110/120	KXRL138
Momentary	Start (Green)	On (Red)	Off (Green)	Stop (Red)	2 N.C., 2 N.C.	24	KXRL34GRGRH2
Momentary	Start (Green)	On (Red)	Off (Green)	Stop (Red)	1 N.O., 1 N.C.	24	KXRL34GRGRH37

KX Square Selector Switches with Contacts

Table 19.309: Selector Switches—with Contacts



Description	Legend	Knob	Contacts		Type [1]
			1	0	
2-position, maintained	Off-On	Black	1	0	KXSA125
			0	1	
2-position, maintained	Off-On	Black	1	0	KXSA139
3-position, maintained	Hand-Off-Auto	Black	1	0	KXSD126
			0	0	

KX Square Potentiometers

Table 19.310: Potentiometers



Description	Power	Resistance	Type [1]
Single	2 W	3.2 kW	KXBB06
Single	2 W	5 kW	KXBB07
Single	2 W	10 kW	KXBB08
Tandem	2 W	5 kW / 5 kW	KXBD83

[1] When ordering, add prefix 9001 to the catalog number.
[2] Maintained operators are mechanically interlocked
[3] Text is vertical

KX Square Pilot Lights

Table 19.311: Pilot Lights^[4]

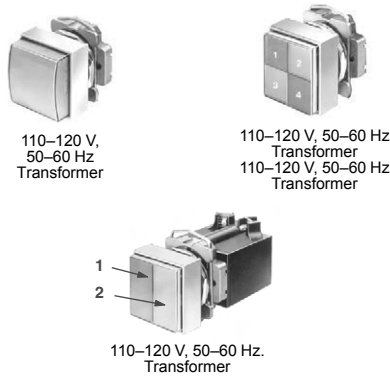

Description	Voltage	Lens 1	Lens 2	Lens 3	Lens 4	Type ^[5]
Single	24	Amber				KXPA35A
Single	24	Red				KXPA35R
Single	24	Green				KXPA35G
Single	24	White				KXPA35W
Single	110/120	Amber				KXPA1A
Single	110/120	Red				KXPA1R
Single	110/120	Green				KXPA1G
Single	110/120	White				KXPA1W
Dual	24	Amber	Amber			KXPB34AA
Dual	24	Red	Red			KXPB34RR
Dual	24	Green	Green			KXPB34GG
Dual	24	White	White			KXPB34WW
Dual	24	Red	Green			KXPB34RG
Dual	110/120	Amber	Amber			KXPB1AA
Dual	110/120	Red	Red			KXPB1RR
Dual	110/120	Green	Green			KXPB1GG
Dual	110/120	White	White			KXPB1WW
Dual	110/120	Red	Green			KXPB1RG
Quad	24	White	Amber	Green	Red	KXPC34WAGR
Quad	110/120	White	Amber	Green	Red	KXPC1WAGR
Quad	110/120	White	Blue	Green	Red	KXPC1WLGR

KX Square Push Buttons without Contacts

Table 19.312: Push Buttons—without Contacts ^[6]



Push Button	Action	Lens Color (1)	Lens Color (2)	Type ^[5]	
Single Push Button 	Non-Illuminated	Momentary	Amber	—	KXRAA
			Green	—	KXRAG
			Blue	—	KXRAL
			Red	—	KXRAR
			White	—	KXRAW
	Illuminated 24 V	Momentary	Amber	—	KXRB35A
			Green	—	KXRB35G
			Blue	—	KXRB35L
			Red	—	KXRB35R
			White	—	KXRB35W
	Illuminated 110/120 V	Momentary	Amber	—	KXRB38A
			Green	—	KXRB38G
			Blue	—	KXRB38L
			Red	—	KXRB38R
			White	—	KXRB38W
Dual Push Button 	Non-Illuminated	Momentary + Interlock	Green	Red	KXRCGR
			White	White	KXRCWW
		Maintained + Interlock	Green	Green	KXRCGG
			Green	Red	KXREGR
			White	White	KXREWW
			Green	Green	KXREGG

Table 19.313: Dual Push Button with Pilot Light—without Contacts ^[6]

Action	Voltage	Lens Color (1)	Lens Color (2)	Lens Color (3)	Lens Color (4)	Type ^[5]		
With One Pilot Light								
	Momentary	24 Vac/dc	Red	White	Green	—	KXRG35RWG	
		24 Vac/dc	Green	White	Green	—	KXRG35GWG	
		110/120 Vac/dc	Red	White	Green	—	KXRG38RWG	
	Momentary + Interlock	110/120 Vac/dc	Green	White	Green	—	KXRG38GWG	
		24 Vac/dc	Red	White	Green	—	KXRH35RWG	
		24 Vac/dc	Green	White	Green	—	KXRH354GWG	
Maintained + Interlock	110/120 Vac/dc	Red	White	Green	—	KXRH38RWG		
	110/120 Vac/dc	Green	White	Green	—	KXRH38GWG		
	24 Vac/dc	Red	White	Green	—	KXRJ35RWG		
	24 Vac/dc	Green	White	Green	—	KXRJ35GWG		
	110/120 Vac/dc	Red	White	Green	—	KXRJ38RWG		
	110/120 Vac/dc	Green	White	Green	—	KXRJ38GWG		
With Two Pilot Lights								
	Momentary	24 Vac/dc	Red	White	White	Green	KXRL35RWWG	
		24 Vac/dc	Red	Red	Green	Green	KXRL35GGRR	
		110/120 Vac/dc	Red	White	White	Green	Green	KXRL38RWWG
	Momentary + Interlock	110/120 Vac/dc	Red	Red	Green	Green	KXRL38GGRR	
		24 Vac/dc	Red	White	White	Green	Green	KXRM35RWWG
		24 Vac/dc	Red	Red	Green	Green	Green	KXRM35RRGG
Momentary + Interlock	110/120 Vac/dc	Red	White	White	Green	Green	KXRM38RWWG	
	110/120 Vac/dc	Red	Red	Green	Green	Green	KXRM38RRGG	

Also see *KX Accessories*, page 19-105.

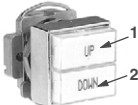
[4] Lenses are blank (no markings)
 [5] When ordering, add prefix 9001 to the catalog number.
 [6] Order contact blocks separately (See *Table 19.315 Contact Blocks*, page 19-104.)

KX Square Selectors without Contacts







Table 19.314: Selectors—without Contacts [7]



Description	Voltage	Knob Color	Type [8]	
2-Position, Maintained	Non-Illuminated	—	Black	KXSAEB
	Illuminated	24 Vac/dc	Red	KXSJE35R
	Illuminated	24 Vac/dc	Green	KXSJE35G
	Illuminated	24 Vac/dc	White	KXSJE35W
	Illuminated	120 Vac/dc	Red	KXSJE38R
	Illuminated	120 Vac/dc	Green	KXSJE38G
	Illuminated	120 Vac/dc	White	KXSJE38W
	Key (Withdraw L)	—	N/A	KXSRE1
	Key (Withdraw R)	—	N/A	KXSRE2
	Key (Withdraw Both)	—	N/A	KXSRE3
3-Position, Maintained	Non-Illuminated	—	Black	KXSDB
	Key (Withdraw C)	—	N/A	KXSVC5
	Key (Withdraw All)	—	N/A	KXSVC10
4-Position, Maintained	Non-Illuminated	—	Black	KXSHHB

Contact Blocks

Table 19.315: Contact Blocks—Purchase Separately

Description	Type [8]
 (Clear Cover)	1 N.O., 1 N.C. KA1
 (Green Cover)	1 N.O. KA2
 (Red Cover)	1 N.C. KA3
 (Clear Cover)	1 N.C., 1 N.O. (Early Make) KA4
 (Red Cover)	1 N.C. (Late Break) KA5
 (Green Cover)	1 N.O. (Early Make) KA6

[7] Order contacts separately (See Table 19.315 Contact Blocks, page 19-104)

[8] When ordering, add prefix 9001 to the catalog number.

Table 19.316: Legend Plates for Selector Switches

Marking	Used On [9]	
	KXSA, KXSB, KXSC, KXSD, KXSE, KXSF, KXSG, KXSH, KXSJ, KXSK, KXSL, KXSM, KXSN, KXSO, KXSP, KXSQ	KXSR, KXSS, KXST, KXSV, KXSW, KXSX, KXSY, KXSZ
	KXN-600	KXN-700
Blank	KXN600	KXN700
For-Rev.	KXN639	KXN739
Hand-Auto	KXN640	KXN740
Man-Auto	KXN643	KXN743
Off-On	KXN644	KXN744
On-Off	KXN645	KXN745
Open-Close	KXN646	KXN746
Start-Stop	KXN651	KXN751
Auto-Off-Hand	KXN658	KXN758
Hand-Off-Auto	KXN660	KXN760
Man-Off-Auto	KXN662	KXN762
Special Marking	KXN699	KXN799

Type KX Legend Plates

Table 19.317: Legend Plates for Push Buttons or Pilot Lights

Marking	Used On [9]					
	A	B	C	D	E	F
	A	B C (vertical)		D	E	F
Blank	KXN100	KXN200	KXN200	KXN300	KXN400	KXN500
Start	KXN101	KXN201	KXN201V	KXN301	KXN401	KXN501
Stop	KXN102	KXN202	KXN202V	KXN302	KXN402	KXN502
On	KXN103	KXN203	KXN203V	KXN303	KXN403	KXN503
Off	KXN104	KXN204	KXN204V	KXN304	KXN404	KXN504
Emerg. Stop	KXN105	KXN205	KXN205V	KXN305	KXN405	KXN505
Forward	KXN106	KXN206	KXN206V	KXN306	KXN406	KXN506
Reverse	KXN107	KXN207	KXN207V	KXN307	KXN407	KXN507
Close	KXN108	KXN208	KXN208V	KXN308	KXN408	KXN508
Open	KXN109	KXN209	KXN209V	KXN309	KXN409	KXN509
Down	KXN110	KXN210	KXN210V	KXN310	KXN410	KXN510
Up	KXN111	KXN211	KXN211V	KXN311	KXN411	KXN511
Jog	KXN118	KXN218	KXN218V	KXN318	KXN418	KXN518
Reset	KXN123	KXN223	KXN223V	KXN323	KXN423	KXN523
Run	KXN124	KXN224	KXN224V	KXN324	KXN424	KXN524
Cycle Start	KXN132	KXN232	KXN232V	KXN332	KXN432	KXN532
Motor Run	KXN136	KXN236	KXN236V	KXN336	KXN436	KXN536
Power On	KXN138	KXN238	KXN238V	KXN338	KXN438	KXN538
Special-Marking	KXN199	KXN299	KXN299V	KXN399	KXN499	KXN599

Table 19.318: Letter Height For Standard Legends

	in.	mm
KXN100	1/4	6
KXN200	3/16	4.75
KXN300	3/16	4.75
KXN400	3/16	4.75
KXN500	3/16	4.75
KXN600	1/8	3
KXN700	1/8	3

Table 19.319: Maximum Number of Lines and Characters For Type KXN Legend Inserts

Letter Height	Number of ...	KXN199	KXN299 Horizontal	KXN299 Vertical	KXN399	KXN499	KXN599	
								in.
1/4	6	Characters per Line	7	7	3	7	7	3
		Lines per Legend Insert	4	2	4	1	1	1
3/16	4.75	Characters per Line	9	9	4	9	9	4
		Lines per Legend Insert	5	2	6	2	1	2
1/8	3	Characters per Line	14	14	5	14	14	6
		Lines per Legend Insert	8	4	9	3	2	3

Table 19.320: Maximum Number of Lines and Characters for Type KXN699 and KXN799 Legend Plates

Position	Letter Height		Characters Per Marking Area	
	in.	mm	A and C	B
	3/16	4.75	6	6
	1/8	3	8	9
	3/16	4.75	10	5
	1/8	3	13	7

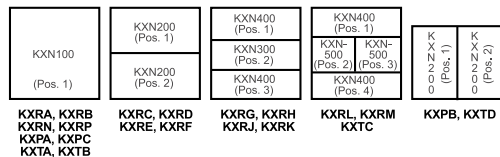

All Type KX push buttons and pilot lights have a blank insert as standard. These blank inserts can be custom marked using a marking pen, a mechanical lettering set, press letters, or a tape lettering machine that marks a tape which can then be transferred to the blank insert.

To have legend inserts installed into the operators, order the operator as normal and then indicate where to install the legend inserts using the numbered positions shown on the operator ordered.

Example: 9001KXRL1GRGRH2 with a
9001KXN 401 in position 1
9001KXN 503 in position 2
9001KXN 504 in position 3
9001KXN 402 in position 4

[9] When ordering, add prefix 9001 to the catalog number.
[10] These legend inserts have vertical printing.
[11] These legend inserts are for the pilot lights in the center of the operator.
[12] These legend inserts are for the push button portion of the operator.

Additional Accessories for Type KX Operators

Table 19.321: Closing Plate

Description	Type
 UL Types 4, 13/NEMA 4, 13 Square Closing Plate (Chrome Plated) Same size as KX bezel	KXAK52

Table 19.322: Boots

Description	For Use On	Type
	All KX** push buttons and pilot lights	KXAKU7
	All KX** selector switches and potentiometers	KXAKU17B

Table 19.323: Shrouds

Description	For Use On	Color	Type
	Full Shroud	Red	KXAK41R
		Black	KXAK41B
	Short Shroud	Red	KXAK40R
		Black	KXAK40B

Table 19.324: Lamp and Lens Removal Kit













Description	Type
 Used to remove lamp and lens on all illuminated operators and pilot lights.	KXALLRT

Table 19.325: Button Covers

Description	For Use On	Color	Type	Code
 Includes 2-KXN200	KXPB KXTD	Red Green Amber Blue White	KXAC28 [13] KXAC28 [13] KXAC28 [13] KXAC28 [13] KXAC28 [13]	R [14] G [14] A [14] L [14] W [14]
 Includes KXN400	KXTC (Position 1 & 4)	Red Green Amber Blue White	KXAR4 KXAG4 KXAA4 KXAL4 KXAW4	R G A L W
 Includes KXN500	KXTC (Position 2 & 3)	Red Green Amber Blue White	KXAR5 KXAG5 KXAA5 KXAL5 KXAW5	R G A L W
 Includes 1-KXN100	KXPC	Red Green Amber Blue White	KXAC48 [15] KXAC48 [15] KXAC48 [15] KXAC48 [15] KXAC48 [15]	R [16] G [16] A [16] L [16] W [16]
 Includes KXN100	KXRA KXRB	Red Green Amber Blue White	KXAR1 KXAG1 KXAA1 KXAL1 KXAW1	R G A L W
 Includes KXN100	KXRN KXRP	Red Green Amber Blue White	KXARM1 KXAGM1 KXAA1 KXALM1 KXAWM1	R G A L W
 Includes KXN200 [17]	KXRC KXRD KXRE KXRF	Red Green Amber Blue White	KXAR2 KXAG2 KXAA2 KXAL2 KXAW2	R G A L W
 Includes KXN300	KXRG (Position 2) KXRH (Position 2) KXRJ (Position 2) KXRK (Position 2)	Red Green Amber Blue White	KXAR3 KXAG3 KXAA3 KXAL3 KXAW3	R G A L W
 Includes KXN400	KXRG (Position 1 & 3) KXRH (Position 1 & 3) KXRJ (Position 1 & 3) KXRK (Position 1 & 3) KXRL (Position 1 & 4) KXRM (Position 1 & 4)	Red Green Amber Blue White	KXAR4 KXAG4 KXAA4 KXAL4 KXAW4	R G A L W
 Includes KXN500	KXRL (Position 2 & 3) KXRM (Position 2 & 3)	Red Green Amber Blue White	KXAR5 KXAG5 KXAA5 KXAL5 KXAW5	R G A L W
 Includes KXN100	KXPA	Red Green Amber Blue White	KXAR8 KXAG8 KXAA8 KXAL8 KXAW8	R G A L W
 Includes KXN100	KXTA KXTB	Red Green Amber Blue White	KXAR1 KXAG1 KXAA1 KXAL1 KXAW1	R G A L W

[13] Each KXAC28 includes a clear cover and 1 each of all colors. If the same color is required for position #1 and #2 of the KXPB operator, order 2 of Type KXAC28.

[14] When specifying color codes—the first will be installed in #1 and the second in #2.

[15] Each KXAC48 includes a clear cover and 1 each of all colors. If the same color is required for position #1 and #2 of the KXPC operator, order 2 of Type KXAC48.

[16] When specifying color codes—the first will be installed in #1, the second in #2, the third in #3 and the fourth in #4.

[17] Two required per operator. When ordering an assembled operator—specify two code numbers. The first code will be assembled into #1 and the second code will be assembled into #2

XAL Control Stations, Enclosures, and Accessories

Table 19.326: Start or Stop Function Polycarbonate; Light gray base, RAL7035; Dark gray lid, RAL7016



XALD101H29H7

Description	Type of Push	Type of Contact		Marking	Catalog Number
		N.O.	N.C.		
Marking on Legend Holder					
1 momentary push button	Flush black	1	—	Start	XALD101H29H7
	Flush red	—	1	Stop	XALD111H29H7
Marking on Legend Holder					
1 mushroom head push button Ø 40 mm, momentary	Red	—	1	Stop on red legend	XALD164H29H7



XALK174H7

Table 19.327: Trigger Action Emergency Stop Polycarbonate; Light gray base, RAL7035; Yellow lid, RAL1012

Description	Type	Type of Contact		Catalog Number
		N.O.	N.C.	
1 mushroom head push button Ø 40 mm, red Turn-to-release	Trigger action [1]	—	1	XALK178H7
1 mushroom head push button Ø 40 mm, red Key release (Key No. 455)	Trigger action [1]	—	1	XALK188H7
1 mushroom head push button Ø 40 mm, red Push-pull	Trigger action [2]	—	1	XALK198H7

Table 19.328: Start-Stop Function Polycarbonate; Light gray base, RAL7035; Dark gray lid, RAL7016



XALD211H29H7



XALD321H29H7

Description	Type of Push	Type of Contact		Text	Catalog Number
		N.O.	N.C.		
2 momentary push buttons	1 flush black 1 flush red	1 —	— 1	Start Stop	XALD211H29H7
	1 flush black 1 flush black	1 1	— —	Forward Reverse	XALD251H29H7

Table 19.329: Three Function Polycarbonate; Light gray base, RAL7035; Dark gray lid, RAL7016

Description	Type of Push	Type of Contact		Text	Catalog Number
		N.O.	N.C.		
3 momentary push buttons (no markings)	1 flush black 1 flush red 1 flush black	1	—	Open	XALD351H29H7
		—	1	Stop	
		1	—	Close	
		1	—	Forward	XALD311H29H7
		—	1	Stop	
		1	—	Reverse	
3 momentary push buttons (no markings)	1 flush black 1 flush red 1 flush black	1	—	Up	XALD321H29H7
		—	1	Stop Down	

[1] Emergency Stop (EN / IEC 13850)
[2] Emergency Off (IEC 60364-5-53)



ZENL1111



ZALV**

Table 19.330: Empty Enclosures [3]

Description	Number of Holes	Catalog Number
For normal environments, CSA approved and UL Listed (with stainless steel lid mounting screws)		
Light gray base RAL7035 Dark gray lid RAL7016	1	XALD01H7
	2	XALD02H7
	3	XALD03H7
	4	XALD04H7
	5	XALD05H7
Light gray base RAL7035 Yellow lid RAL1012	1	XALK01H7

Table 19.331: Electrical Block and Accessories (for mounting on metal plate at back of enclosure) [3]

Description	Type	Color	Catalog Number
Electrical blocks with screw clamp terminal connections			
Metal-plate-mounting contact blocks	N.O. contact	—	ZENL1111
	N.C. contact	—	ZENL1121
Light blocks with Protected LED	24 Vac/Vdc	White	ZALVB1
		Green	ZALVB3
		Red	ZALVB4
		Yellow	ZALVB5
		Blue	ZALVB6
		120 Vac	White
	Green		ZALVG3
	Red		ZALVG4
	Yellow		ZALVG5
	Blue		ZALVG6
	230 Vac		White
		Green	ZALVM3
Red		ZALVM4	
Yellow		ZALVM5	
Blue		ZALVM6	

Table 19.332: Accessories for electrical blocks

Description	Application	Catalog Number
Blanking plug	Ø 22 mm units	ZB5S23
Nut	Head mounting	ZB5AZ901
Grounding terminal	Grounding	XALZ09
Key	For tightening nut	ZB5AZ905



ZB5S23

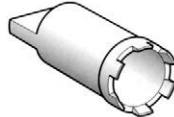

ZB5AZ905

XAP Enclosures and Accessories

Table 19.333: Undrilled Enclosures, Glass-Reinforced Polyester

Type		H x W Dimensions		Catalog Number
		IN	mm	
NEMA 4, 4X, 13 Usable depth 3.27 in. (83 mm)	Without hinges	3.34 x 5.75	85 x 146	XAPA1100
		3.34 x 8.90	85 x 226	XAPA2100
	With hinges	5.95 x 9.49	151 x 241	XAPA3100
		5.95 x 9.49	151 x 241	XAPA4100
Undrilled Grounding Plate	Sheet steel with ground screw	For XAPA1100		XAPZ100
		For XAPA2100		XAPZ200
		For XAPA3100 and 4100		XAPZ300



XAPA1100

Table 19.334: Drilled Insulated Enclosures, Glass-Reinforced Polyester [4]

Type	Number of Knockouts 22 mm	Number of Rows		H x W Dimensions		Catalog Number
		Vertical	Horizontal	IN	mm	
NEMA 4, 4X, 13 Usable depth 3.27 in. (83 mm) 1.58 in. (40 mm) centerline spacing of holes	1	1	1	3.35 X 5.75	85 X 146	XAPA1110
	2	1	2	3.35 X 5.75	85 X 146	XAPA1120
	4	2	2	3.35 X 5.75	85 X 146	XAPA1104
	8	2	4	3.35 X 8.90	85 X 226	XAPA2108
	16	4	4	5.94 X 9.49	151 X 241	XAPA3116
	Drilled Grounding Plate	Sheet steel with ground screw		For XAPA1110		XAPZ110
For XAPA1120				XAPZ120		
For XAPA1104				XAPZ104		
For XAPA2108				XAPZ208		
For XAPA3116				XAPZ316		



XAPA1104

Table 19.335: Undrilled Die Cast Enclosures (Painted Gray RAL7032)

Type	Material	Usable Depth		H x W x D Dimensions		Catalog Number
		IN	mm	IN	mm	
NEMA 4, 13	Zinc	1.93	49	3.15 x 3.15 x 2.03	80 x 80 x 51.5	XAPG19100
				5.12 x 3.15 x 2.03	130 x 80 x 51.5	XAPG29100
				6.89 x 3.15 x 2.03	175 x 80 x 51.5	XAPG39100
		2.93	74.5	3.15 x 3.15 x 3.03	80 x 80 x 77	XAPG19400
				5.12 x 3.15 x 3.03	130 x 80 x 77	XAPG29400
				6.89 x 3.15 x 3.03	175 x 80 x 77	XAPG39400
	Aluminum	2.93	2.93	12.20 x 3.35 x 3.03	310 x 85 x 77	XAPG59400



XAPG39400

[3] For customer assembly using XB5 operators and standard screw-terminal contact blocks, see XB5 Non-Illuminated Operators, page 19-46. Either mounting method can be used: contact block ZENL mounting on metal plate, or contact block ZBE mounting on operator with mounting collar.
[4] Uses standard XB5 products from XB5 Complete Devices, page 19-43 through XB5 Accessories, page 19-60. Do not use ZENL style contact blocks.

Table 19.336: Drilled Die Cast Enclosures (Painted Gray RAL7032) [5]

	Type	Material	Usable Depth		Number of 22 mm holes	H x W x D Dimensions		Catalog Number
			IN	mm		IN	mm	
 XAPG29703	NEMA 4, 13 1.18 in. (30 mm) centerline spacing of holes for horizontal mount	Zinc	1.93	49	2	3.15 x 3.15 x 2.03	80 x 80 x 51.5	XAPG19702
					3	5.12 x 3.15 x 2.03	130 x 80 x 51.5	XAPG29703
					4	6.90 x 3.15 x 2.03	175 x 80 x 51.5	XAPG39704
			2.93	74.5	2	3.15 x 3.15 x 3.03	80 x 80 x 77	XAPG19802
					3	5.12 x 3.15 x 3.03	130 x 80 x 77	XAPG29803
					4	6.90 x 3.15 x 3.03	175 x 80 x 77	XAPG39804
	NEMA 4, 13 1.58 in. (40 mm) centerline spacing of holes for vertical mount	Zinc	1.93	1.93	1	3.15 x 3.15 x 2.03	80 x 80 x 51.5	XAPG19201
					2	5.12 x 3.15 x 2.03	130 x 80 x 51.5	XAPG29202
					3	6.90 x 3.15 x 2.03	175 x 80 x 51.5	XAPG39203
			2.93	74.5	1	3.15 x 3.15 x 3.03	80 x 80 x 77	XAPG19501
2					5.12 x 3.15 x 3.03	130 x 80 x 77	XAPG29502	
3					6.90 x 3.15 x 3.03	175 x 80 x 77	XAPG39503	
Aluminum		2.93	74.5	4	8.66 x 3.15 x 3.03	220 x 80 x 77	XAPG49504	
5		12.20 x 3.35 x 3.03	310 x 85 x 77	XAPG59505				

Table 19.337: Drilled Flush Plates [5]

Type	Material	Number of 22 mm holes	H x W x D Dimensions		Catalog Number
			IN	mm	
NEMA 4, 13 1.18 in. (30 mm) centerline spacing of holes	Anodized Aluminum	1	2.83 x 2.83	72 x 72	XAPE301
		2	4.13 x 2.83	105 x 72	XAPE302
		3	5.43 x 2.83	138 x 72	XAPE303
		4	6.73 x 2.83	171 x 72	XAPE304
		5	8.03 x 2.83	204 x 72	XAPE305

Table 19.338: Optional Back Box (for finger protection, if required)

Type	Material	For Use With	Catalog Number
Protective rear covers	Insulating Fiberglass	Flush plate XAPE301	XAPE901
		Flush plate XAPE302	XAPE902
		Flush plate XAPE303	XAPE903
		Flush plate XAPE304	XAPE904
		Flush plate XAPE305	XAPE905



XAPE302



XAPE303

[5] Can use either XB4 or XB5 products.

9001B Standard Duty Control Stations

Table 19.339: Control Stations

No. of Buttons	Nameplate Markings and Features	Contact Symbol [6]	Surface Mounting NEMA1	Stainless Steel Flush Plate [7]	Watertight and Dusttight NEMA4	For Hazardous Locations NEMA 7 & 9 [8]
			Type [9]	Type [9]	Type [9]	Type [9]
1	Start	1	BG101	BF101	BW146	BR101
	Stop	3	BG102	BF102	BW147	—
	Stop (Mushroom Button)	3	BG103	—	BW151	BR103
	Stop (Lockout)	3	BG104	—	BW148	BR104
	Universal (w/o legend insert)	16	BG107	BF107	BW159	BR107
	Off-On (Selector Switch)	19	BG111	—	—	—
	Hand-Off-Auto (Selector Switch)	17	BG112	—	—	—
	Universal Selector Switch (w/o legend insert)	19 or 17	BG114	—	—	—
2	Start-Stop	145	BG201	BF201	BW240	BR204
	Start-Stop (for latching Applications)	146	BG202	—	BW252	BR202
	Start-Stop (Mushroom on Stop)	145	BG203	—	BW250	BR203
	Start-Stop (Lockout on Stop)	145	BG204	—	BW241	BR204
	Start-Stop (Mushroom on both)	145	BG205	—	BW246	BR205
	Forward-Reverse	146	BG206	—	BW242	—
	Open-Close	146	BG207	—	BW244	—
	Up-Down	146	BG208	BF208	BW243	BR208
	Raise-Lower	146	BG209	—	BW253	—
	On-Off	145	BG210	BF210	BW245	—
	On-Off	146	BG211	BF211	BW254	—
	Universal (w/o legend inserts)	25	BG214	—	BW260	BR214
	Start-Stop (Maintained Contact)	10	BG215	BF215	BW255	BR215
	On -Off (Maintained Contact)	10	BG216	BF216	BW256	BR216
	Universal (Maintained contact w/o legend inserts)	10	BG218	—	—	BR218
	3	Fast-Slow-Stop	109	BG301	—	—
Forward-Reverse-Stop		109	BG302	—	—	—
Opn-Close-Stop		109	BG303	BF303	—	—
Raise-Lower-Stop		109	BG304	—	—	—
Up-Down-Stop		109	BG305	BF305	—	—
Start-Jog-Stop		109	BG316	—	—	—
Universal (w/o legend inserts)		8	BG307	—	—	—
Start-Stop, Red Pilot Light: 120Vac/dc		145 & 121	BG308	BF308	—	—



NEMA 1 Surface Mounting Type BG201



NEMA 1 Flush Mounting (w/o pullbox) Type BF201



NEMA 4 Type BW243



NEMA 7 and 9 Type BR103

Table 19.340: Accessories

Description	Color	Type [9]
Mushroom Caps for NEMA 1	Red	B301
Mushroom Caps for NEMA 4	Red	B303
Lockout Kit for NEMA 1	—	B321
Pilot Light Lenses, NEMA 1 Surface Mount	Red	B331
Pilot Light Lenses, NEMA 1 Surface Mount	Green	B332
Pilot Light Lenses, NEMA 1 Flush Mount	Red	B341
Pilot Light Lenses, NEMA 1 Flush Mount	Green	B342
Replacement Covers for BW240 [10]	—	BWD219
Replacement Covers for BW241 [11][10]	—	BWD220
Replacement Covers for BW242-BW260 [10]	—	BWD219

Table 19.341: Interchangeable Push Button Legend Inserts

Marking	For NEMA 1 Surface Mount [9]	For NEMA 4 or 7/9 Lever Type [9]	For NEMA 4 Round Button [9]	For NEMA4 Mushroom Button [9]
Start	B101	B161	B259	B282
Stop	B102	B162	B260	B283
Fast	B103	—	—	—
Slow	B104	—	—	—
Forward	B105	—	B255	—
Reverse	B106	—	B256	—
Open	B107	—	B263	—
Close	B108	—	B264	—
Raise	B109	—	B261	—
Lower	B110	—	B262	—
Up	B111	—	B253	B276
Down	B112	—	B254	B277
On	B115	B175	B257	—
Off	B116	B176	B258	—
Hand	B117	—	B265	—
Auto	B118	—	B266	—
Jog	B119	—	—	—
Blank (Black)	B129	B189	B251	B251
Blank (Red)	B129R	B189R	B252	B252

For Replacement Interiors, see Replacement Interiors for Type B Standard Duty Push Button Stations, page 19-111.

For Ratings, see Electrical Contact Ratings, page 19-111.

[6] See Table 19.342 Replacement Interiors For Type B Standard Duty Push Button Stations , page 19-111.
 [7] Uses standard 2.0 or 2.13 in. deep wall boxes, single gang for Types BF1 and BF2, two gang for Type BF3
 [8] Also rated for Class I, Division I and II, Groups B, C, or D; Class II, Division I and II, Groups E, F, or G
 [9] When ordering, add prefix 9001 to the catalog number.
 [10] Replacement case/covers are not available for Type BR devices.
 [11] Includes factory installed lockout on the cover.

Replacement Parts for Type B Standard Duty Control Stations

Table 19.342: Replacement Interiors For Type B Standard Duty Push Button Stations



Type BGC214
(Type BGC contact block assemblies include cover.)



Type BGB214



BOC361

For Control Station Type	Contact Symbol	Contact Block Assembly [1]	Terminal Block Wiring Receptacle
		Type	Type
BF101–BF107	16	BOC107	BFB107
BF111–BF114	19 or 17	BOC114	BFB114
BF121–BF123	121	BOC123	BFB123
BF201–BF214	25	BOC214	BFB214
BF215–BF218	10	BOC218	BFB214
BF221–BF224	7 or 19 & 121	BOC224	BFB224
BF225–BF226	17 or 19 & 16	BOC226	BFB226
BF301–BF307	8	BOC214 & BOC107	BFB214 & BFB107
BF308–BF309	25 & 121	BOC214 & BOC123	BFB214 & BFB123
BF310–BF313	10 & 121	BOC218 & BOC123	BFB214 & BFB123
BF314–BF315	17 or 19 & 25	BOC214 & BOC114	BFB214 & BFB114
BG101–BG107	16	BGC107	BGB107
BG111–BG114	17 or 19	BGC114	BGB114
BG121–BG123	121	BGC123	BGB123
BG201–BG214	25	BGC214	BGB214
BG215–BG218	10	BGC218	BGB214
BG221–BG224	17 or 19 & 121	BGC224	BGB224
BG225–BG226	17 or 19 & 16	BGC226	BGB226
BG301–BG307	8	BGC307	BGB307
BG316–BG326			
BG308–BG309	25 & 121	BGC309	BGB309
BG310–BG313	10 & 121	BGC313	BGB309
BG314–BG315	17 or 19 & 25	BGC315	BGB315
BR101–BR107	16	BOC107	BFB107
BR202–BR214	25	BOC214	BFB214
BR215–BR219	10	BOC218	BFB214
BW101–BW107	16	BOC107	BFB107
BW202–BW214	25	BOC214	BFB214
BW215–BW218	10	BOC218	BFB214
BW146–BW159	16	BOC360	
BW240–BW260	25	BOC361	
BW255–BW258	10	BOC362	

NOTE: Contact block assemblies for all Type BG stations include cover and contact block. Replacement contact block assemblies and terminal block wiring receptacles for push buttons have provision for 1 N.O. & 1 N.C. circuit on each button. Unneeded circuits need not be wired.

Table 19.343: Mounting Bracket

Description	Catalog Number
C-Shaped Mounting Bracket for 9001BR Interior	3110112001

Table 19.344: Electrical Contact Ratings [2]

Volts	AC—NEMA B600					DC—NEMA P600			
	Inductive 35% Power Factor				Continuous Carrying Amperes	Resistive 75% Power Factor	Inductive and Resistive		
	Make		Break				Volts	Make and Break Amperes	Continuous Carrying Amperes
A	VA	A	VA	Make, Break and Continuous Carrying Amperes					
120	30.5	3600	3.75	360	5	5	120	1.1	5
240	15	3600	1.5	360	5	5	240	0.55	5
480	7.5	3600	.75	360	5	5	600	0.2	5
600	6	3600	.6	360	5	5			

Contact Symbols

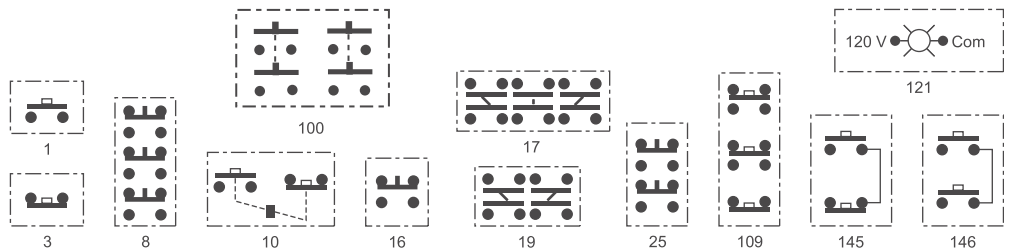

[1] Order separate legend plates, if required, from Table 19.341 Interchangeable Push Button Legend Inserts, page 19-110.
[2] OSHA Regulation, Section 1910.70, Overhead and Gantry Cranes, limits the voltage of pendant push buttons to 150 Vac or 300 Vdc.

9001KY and 9001SKY Control Stations

Table 19.345: Empty Enclosures (for Customer Assembly) [1]

	UL Types 1, 3 and 13/ NEMA 1, 3, and 13	UL Types 1, 3, 4 and 13/ NEMA 1, 3, 4 and 13	UL Types 1, 3, 4, 4X and 13/ NEMA 1, 3, 4, 4X and 13	
				
No of Holes	Sheet Steel Type	Die Cast Zinc Type	Stainless Steel (304) Type	Polymeric (Plastic) Type
1	KYAF1	KY1	KYSS1	SKY1
2	KYAF2	KY2 [2]	KYSS2	SKY2
3	KYAF3	KY3 [2]	KYSS3	SKY3
4	KYAF4	KY4 [2]	KYSS4	SKY4
6	KYAF6	KY6	KYSS6	SKY6

NOTE: See Table 19.348 Assembled Control Stations, page 19-113

Table 19.346: Guarded Enclosures

No of Holes	UL Types 1, 3, 4 and 13/ NEMA 1, 3, 4 and 13		
	Cover Color	Die Cast Zinc Box Color	Type
1	Gray	Gray	KYG1 [3]
1	Yellow	Gray	KYG1Y [3]

NOTE: See Table 19.348 Assembled Control Stations, page 19-113

Table 19.347: Stainless Steel (302) NEMA 1 Flush Plates [4]

No of Holes	Description	Type
1	1 Hole flush plate, cover screws, insulating liners	K25
2	2 Hole flush plate, cover screws, insulating liners	K26
3	3 Hole flush plate, cover screws, insulating liners	K27
4	4 Hole flush plate, cover screws, insulating liners	K28



KYG1Y
(mushroom head not included)



K26

[1] When ordering, add prefix 9001 to the catalog number.

[2] Only KN200 series legend plates will fit upright on these enclosures with their long axis vertical.

[3] Includes 1" NPT threaded conduit opening.

[4] To be used with a standard 2 x 3 in. general purpose switch box. A 2.5 in. deep switch box should be used if two Type KA contact blocks are mounted side by side. If two Type KA contact blocks are mounted in tandem, a 3.5 in. deep box should be used.

Assembled 9001KY/SKY Control Stations

Table 19.348: Assembled Control Stations

	No of Holes	Operator Style and Features	Type	Consists of					
				Enclosure	Operators	Contact Blocks	Legend Plates		
UL Types 1, 3, 4 and 13/NEMA 1, 3, 4 and 13 Die Cast Zinc Enclosure [5]									
	1	Selector Switch (3 Pos Maintained)	KYK111	KY1	KS43B	KA1	Hand-Off-Auto		
		Selector Switch (2 Pos Maintained)	KYK110	KY1	KS11B	KA1	Off-On		
		Push Button (Momentary)	KYK11	KY1	KR1B	KA1	Start		
		Push Button (Momentary)	KYK13	KY1	KR1R	KA1	Stop		
		Mushroom Button (Momentary)	KYK14	KY1	KR4R	KA1	Stop		
		Push Button (with Lockout)	KYK15	KY1	KR3R, K4	KA1	Stop		
		Break Glass Operator	KYK116	KY1	K15	KA1	To Stop—Break Glass		
		Break Glass Operator (Red Enclosure)	KYK117	KY1S1	K15	KA1	To Stop—Break Glass		
		2 Push Buttons (Lockout on Stop)	KYK224	KY2	KR1B, KR3R, K4	KA1, KA1	Jog-Stop		
		2 Push Buttons	KYK218	KY2	KR1B, KR3R	KA1, KA1	On-Off		
2	2	2 Push Buttons	KYK26	KY2	KR1B, KR1B	KA1, KA1	Open-Close		
		2 Push Buttons	KYK25	KY2	KR1B, KR1B	KA1, KA1	Up-Down		
		2 Push Buttons	KYK21	KY2	KR1B, KR3R	KA1, KA1	Start-Stop		
		2 Push Buttons (with Sealed Contacts) [6]	KYK223	KY2	KR1B, KR3R	KA51, KA51	Start-Stop		
		2 Push Buttons (Lockout on Stop)	KYK23	KY2	KR1B, KR3R, K4	KA1, KA1	Start-Stop		
		2 Push Buttons (Maintained/Interlocked)	KYK27	KY2	KR11GR	KA1	Start-Stop		
		1 Push Button, 1 Mushroom Button	KYK22	KY2	KR1B, KR4R	KA1, KA1	Start-Stop		
		3 Push Buttons	KYK31	KY3	KR1B, KR1B, KR3R	KA1, KA1, KA1	Forward; Reverse; Stop		
		3 Push Buttons (Lockout on Stop)	KYK326	KY3	KR1B, KR1B, KR3R, K4	KA1, KA1, KA1	Forward; Reverse; Stop		
		3 Push Buttons (With Sealed Contacts & Lockout on Stop) [6]	KYK322	KY3	KR1B, KR1B, KR3R, K4	KA51, KA51, KA51	Forward; Reverse; Stop		
3	3	3 Push Buttons	KYK33	KY3	KR1B, KR1B, KR3R	KA1, KA1, KA1	Open; Close; Stop		
		Red 120v Pilot Light, 2 Push Buttons	KYK317	KY3	KP1R31, KR1B, KR3R	KA2, KA3	Start; Stop		
		3 Push Buttons	KYK32	KY3	KR1B, KR1B, KR3R	KA1, KA1, KA1	Up; Down; Stop		
		3 Push Buttons (Lockout on Stop)	KYK325	KY3	KR1B, KR1B, KR3R, K4	KA1, KA1, KA1	Up ; Down; Stop		
		UL Types 1, 3, 4 and 13/NEMA 1, 3, 4 and 13—Stainless Steel (304) [7]							
		1	1	Push Button (Momentary)	KYSS101	KYSS1	KR1B	KA1	Start
				Push Button (Momentary)	KYSS103	KYSS1	KR1B	KA3	Stop
				Selector Switch (2 Pos Maintained)	KYSS110	KYSS1	KS11B	KA1	Off-On
				Selector Switch (3 Pos Maintained)	KYSS111	KYSS1	KS43B	KA1	Hand-Off-Auto
		2	2	2 Push Buttons	KYSS201	KYSS2	KR1B, KR3R	KA1, KA3	Start; Stop
2 Push Buttons (Lockout on Stop)	KYSS203			KYSS2	KR1B, KR3R, K5	KA1, KA3	Start; Stop		
2 Push Buttons (Maintained with Interlock)	KYSS210			KYSS2	KR11U	KA1, KA1	Start; Stop		
2 Push Buttons	KYSS205			KYSS2	KR1B, KR1B	KA1, KA1	Up; Down		
UL Types 1, 3, 4, 4X and 13/NEMA 1, 3, 4, 4X and 13—Stainless Steel (304) [8]									
1	1	Push Button (Momentary)	KYSK101	KYSS1	SKR1B	KA1	Start		
		Push Button (Momentary)	KYSK103	KYSS1	SKR3R	KA3	Stop		
		Selector Switch (2 Pos Maintained)	KYSK110	KYSS1	SKS11B	KA1	Off-On		
		Selector Switch (3 Pos Maintained)	KYSK111	KYSS1	SKS43B	KA1	Hand-Off-Auto		
2	2	2 Push Buttons	KYSK201	KYSS2	SKR1B, SKR3R	KA1, KA3	Start; Stop		
		2 Push Buttons (Lockout on Stop)	KYSK203	KYSS2	SKR1B, SKR3R, K5	KA1, KA3	Start; Stop		
		2 Push Buttons (Maintained with Interlock)	KYSK210	KYSS2	SKR11U	KA1, KA1	Start; Stop		
		2 Push Buttons	KYSK205	KYSS2	SKR1B, SKR1B	KA1, KA1	Up; Down		
UL Types 1, 3, 4, 4X and 13/NEMA 1, 3, 4, 4X and 13—Polymeric (Plastic) [8]									
1	1	Selector Switch (3 Pos Maintained)	SKY111	SKY1	SKS43B	KA1	Hand-Off-Auto		
		Selector Switch (2 Pos Maintained)	SKY110	SKY1	SKS11B	KA1	Off-On		
		Selector Switch (2 Pos Maintained with Sealed Contacts) [6]	SKY122	SKY1	SKS11B	KA51	Off-On		
		Push Button (with Lockout)	SKY105	SKY1	SKR3R, K5	KA3	Stop		
2	2	2 Push Buttons	SKY201	SKY2	SKR1B, SKR3R	KA1, KA3	Start-Stop		
		2 Push Buttons (Lockout on Stop)	SKY203	SKY2	SKR1B, SKR1R, K5	KA1, KA3	Start-Stop		
		2 Push Buttons (With Sealed Contacts) [6]	SKY223	SKY2	SKR1B, SKR3R	KA51, KA51	Start-Stop		
		2 Push Buttons (With Sealed Contacts) [6]	SKY222	SKY2	SKR1B, SKR3R	KA51, KA51	On-Off		
3	3	2 Push Buttons	SKY205	SKY2	SKR1B, SKR1B	KA1, KA1	Up-Down		
		3 Push Buttons	SKY302	SKY3	SKR1B, SKR1B, SKR3R	KA1, KA1, KA3	Up-Down-Stop		
		3 Push Buttons	SKY303	SKY3	SKR1B, SKR1B, SKR3R	KA1, KA1, KA3	Open-Close-Stop		
		Red 120v Pilot Light, 2 Push Buttons	SKY315A	SKY3	SKP1R31, SKR1B, SKR3R	KA1, KA3	Start-Stop		
UL Types 1, 3, 4 and 13/NEMA 1, 3, 4 and 13 Die Cast Zinc Enclosures with Integral Guard									
1	1	Guarded Enclosure (grey) with 120V Red LED Pilot Light	KYG11 [9]	KYG1	KP38LRR9	—	order separately		
		Guarded Enclosure (grey) with 120V Green LED Pilot Light	KYG12 [9]	KYG1	KP38LGG9	—	order separately		
		Guarded Enclosure (Yellow Cover) with Red Push-Pull Mushroom	KYG1Y1 [9]	KYG1Y	KR9R	KA3	Push to Stop/ Pull to Start		
		Guarded Enclosure (Yellow Cover) with Red Turn-To Release Mushroom	KYG1Y2 [9]	KYG1Y	KR1B	KA3	Emergency Stop		

[5] Uses 9001K metal operators and metal legend plates.
 [6] Control Station consists of components that are UL listed for use in Class 1, Division 2, Groups A, B, C, or D.
 [7] Uses 9001K metal operators and plastic legend plates.
 [8] Uses 9001SK plastic operators and plastic legend plates.
 [9] Includes 1" NPT threaded conduit opening.

New!

Point of Purchase—PoP Products

Schneider Electric has recently expanded its line of Point of Purchase Blister Packs, comprised of 36 popular products, including: push-buttons, pendants, signaling and relay devices. These blister packs are conveniently packaged with all the associated components and accessories that you'll need to complete your installation. Point-of-Purchase packaging makes it easy for you, so you can just grab what you need and go!



9001AB1



9001AE3



XB4AB1



XALACS2



XVCTL1

Table 19.349: 30 mm Push Buttons

Description	Package Includes	Catalog Number
30 mm Push Button with contact block and multi colors	9001KR1U + 9001KA1 + 9001KN201 + 9001KN202	9001AB1
30 mm Push Pull Mushroom	9001KR9R + 9001KA1	9001AB2
30 mm Mushroom with Legend	9001KR5R + 9001KA1 + 9001KN205	9001AB3
30 mm 2 Position Selector Switch with contact and legend	9001KS11B + 9001KA1 + 9001KN244	9001AS1
30 mm 3 Position Selector Switch with contact and legend	9001KS43B + 9001KA1 + 9001KN260	9001AS2
Pilot Light (KP)	9001KP1 + 9001R9 + 9001G9	9001AL1
30 mm Control Station	9001BG201	9001AE3

Table 19.350: 22 mm Push Buttons

Description	Package Includes	Catalog Number
22 mm PB with contact block + 6 colors	ZB4BZ101 + ZB4BA9	XB4AB1
22 mm Mushroom with contact	XB4BS542	XB4AB2
22 mm 2 Position Selector Switch	XB4BD21	XB4AS1
22 mm 3 Position Selector Switch	XB4BJ33	XB4AS2
22 mm control station - Mushroom	XALK178	XALACS1
22 mm control station - 2 button	XALD211	XALACS2

Table 19.351: Pendants

Description	Package Includes	Catalog Number
BW Pendant	9001BW92Y	9001BWP1

Table 19.352: Tower Lights

Description	Package Includes	Catalog Number
40 mm tower light (3) 24V AC/DC	XVC4B3K	XVCTL1

Table 19.353: Power Relays

Description	Package Includes	Catalog Number
Open Power Relay 120VAC, DPDT	8501CO16V20	8501CDPDT
Open Power Relay 120VAC, DPST-N.O.	8501CO7V20	8501CDPST
Open Power Relay 120VAC, SPST-N.O.	8501CO6V20	8501CSPST

Table 19.354: Slim and Interface Relays

Description	Package Includes	Catalog Number
RSL pre-assembled (24V screw conn)	RSL1PVBU + RSLZ5	ASLSCR24
RSL pre-assembled (24V spring conn)	RSL1PRBU + RSLZ5	ASLSPR24
RSL pre-assembled (120 V screw conn)	RSL1PVFU + RSLZ5	ASLSCR120
RSL pre-assembled (120 V spring conn)	RSL1PRFU + RSLZ5	ASLSPR120
RSB1 pre-assembled 24VDC	RSB1A120BD + RSZE1S35M + RZM031RB + RSZR215 + RSZL300	RSB1SOC24D
RSB2 pre-assembled 24VDC	RSB2A080BD + RSZE1S48M + RZM031RB + RSZR215 + RSZL300	RSB2SOC24D

Table 19.355: Plug-In Relays

Description	Package Includes	Catalog Number
RPM1 24 VDC pre-assembled	RPM12BD + RPZF1 + RPZR235 + RXM040W + RXZL520	RPM1SOC24D
RPM1 120 VAC pre-assembled	RPM12F7 + RPZF1 + RPZR235 + RXM021FP + RXZL520	RPM1SOC120A
RXM4 24 VDC pre-assembled	RXM4AB2BD + RXZE2M114 + RXM040W + RXZR335 + RXZL520	RXM4SOC24D
RXM4 120 VAC pre-assembled	RXM4AB2F7 + RXZE2M114 + RXM021FP + RXZR335 + RXZL520	RXM4SOC120A

Table 19.356: Solid State Relays

Description	Package Includes	Catalog Number
10A DIN SSR AC Control	SSRDP8S10A1	SSRDAC10
10A DIN SSR DC Control	SSRDCCS10A1	SSRDC10
20A DIN SSR AC Control	SSRDP8S20A1	SSRDAC20
20A DIN SSR DC Control	SSRDCCS20A1	SSRDC20
10A Panel SSR AC Control + TP	SSRPP8S10A1 + SSRAT1 (1 pc)	SSRPTAC10
10A Panel SSR DC Control + TP	SSRPCDS10A1 + SSRAT1 (1 pc)	SSRPTDC10
25A Panel SSR AC Control + TP	SSRPP8S25A1 + SSRAT1 (1 pc)	SSRPTAC25
25A Panel SSR DC Control + TP	SSRPCDS25A1 + SSRAT1 (1 pc)	SSRPTDC25

XVB 70 mm Diameter Beacons

Table 19.357: XVB Beacons with Steady Light



Description	Light Source and Voltage	Color	Catalog Number
Complete unit, includes: 1 lens unit 1 base unit (direct or tube mounting)	Bulb (10 W max) not included 250 V max (must order bulb separately [1])	Green	XVBL33
		Red	XVBL34
		Amber	XVBL35
		Blue	XVBL36
		Clear	XVBL37
		Yellow	XVBL38

Table 19.358: XVB Beacons with Flashing Light (one flash per second)



Description	Light Source and Voltage	Color	Catalog Number
Complete unit, includes: 1 lens unit 1 base unit (direct or tube mounting)	Bulb (10 W max) not included 24 Vac 24–48 Vdc (must order bulb separately [1])	Green	XVBL4B3
		Red	XVBL4B4
		Amber	XVBL4B5
		Blue	XVBL4B6
		Clear	XVBL4B7
		Yellow	XVBL4B8
	Bulb (10 W max) not included 48–230 Vac (must order bulb separately [1])	Green	XVBL4M3
		Red	XVBL4M4
		Amber	XVBL4M5
		Blue	XVBL4M6
		Clear	XVBL4M7
		Yellow	XVBL4M8

Table 19.359: XVB Beacons with 10 Joule Strobe (2.75 in./70 mm diameter) [2]

Description	Light Source and Voltage	Color	Catalog Number [3]
Complete unit, includes: 1 lens unit 1 base unit (direct or tube mounting)	Strobe 24 Vac/Vdc (includes bulb)	Green	XVBL8B3
		Red	XVBL8B4
		Amber	XVBL8B5
		Blue	XVBL8B6
		Clear	XVBL8B7
		Yellow	XVBL8B8
	Strobe 120 Vac (includes bulb)	Green	XVBL8G3
		Red	XVBL8G4
		Amber	XVBL8G5
		Blue	XVBL8G6
		Clear	XVBL8G7
		Yellow	XVBL8G8

NOTE: There are no replacement lenses for strobes.

[1] For bulbs, see Table 19.365 XVB Accessories, page 19-117.

[2] **Important:** Discharge tube elements are not suitable for continuous-operation signaling due to temperature rise caused by the discharge tube.

[3] For 5 Joule units, specify XVBL6**, instead of XVBL8**.

XVB 70 mm Components

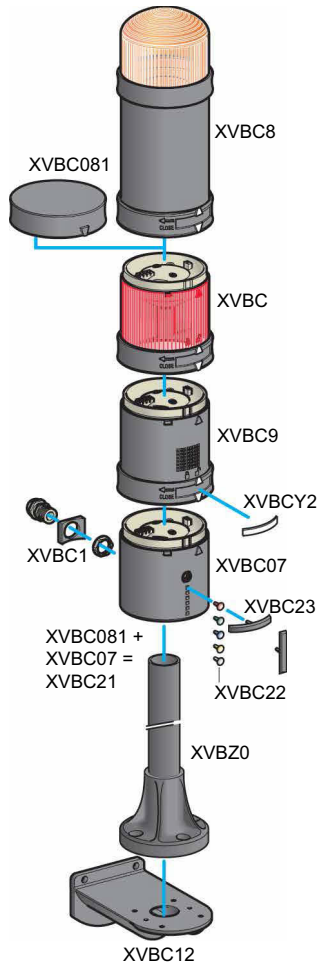

Table 19.360: XVB Lens Units for Steady Light

Description	Light Source and Voltage	Color	Catalog Number
Illuminated lens unit	Bulb (10 W max) not included 250 Vac/Vdc max (must order bulb separately [4])	Green	XVBC33
		Red	XVBC34
		Orange	XVBC35
		Blue	XVBC36
		Clear	XVBC37
		Yellow	XVBC38

Table 19.361: XVB Lens Unit for Flashing Light

Description	Light Source and Voltage	Color	Catalog Number
Illuminated lens unit	Bulb (10 W max) not included 24 Vac 24–48 Vdc (must order bulb separately [4])	Green	XVBC4B3
		Red	XVBC4B4
		Orange	XVBC4B5
		Blue	XVBC4B6
		Clear	XVBC4B7
		Yellow	XVBC4B8
	Bulb (10 W max) not included 48–230 Vac (must order bulb separately [4])	Green	XVBC4M3
		Red	XVBC4M4
		Orange	XVBC4M5
		Blue	XVBC4M6
		Clear	XVBC4M7
		Yellow	XVBC4M8

NOTE: There are no replacement lenses units for the XVBC8** strobes.

Table 19.362: XVB Lens Units with 10 Joule Strobe

Description	Light Source and Voltage	Color	Catalog Number [5]
Lens unit with integral 10 Joule strobe	Strobe 24 Vac/Vdc (includes bulb)	Green	XVBC8B3
		Red	XVBC8B4
		Orange	XVBC8B5
		Blue	XVBC8B6
		Clear	XVBC8B7
		Yellow	XVBC8B8
	Strobe 120 Vac (includes bulb)	Green	XVBC8G3
		Red	XVBC8G4
		Orange	XVBC8G5
		Blue	XVBC8G6
		Clear	XVBC8G7
		Yellow	XVBC8G8

Table 19.363: Audible Sounder Units

Description	Supply Voltage	Catalog Number
Sounder unit 90 dB at 1 m	12–48 Vac/Vdc	XVBC9B
Adjustable from 75–90 dB Continuous or intermittent modes	120–230 Vac	XVBC9M

Table 19.364: Base Units + Cover

Description	Catalog Number
Base unit + cover for direct or tube mounting, bottom or side cable entry (includes gasket)	XVBC21

[4] For bulbs, see Table 19.365 XVB Accessories, page 19-117.

[5] For 5 Joule units, specify XVBC6**, instead of XVBC8**

XVB 70 mm Accessories

Table 19.365: XVB Accessories

Description	Characteristics		Catalog Number	
	in.	mm		
Black tube with integral black plastic mounting base (includes gasket)	4.72	120	XVBZ02	XVBZ02A [6]
	15.75	400	XVBZ03	XVBZ03A [6]
	31.50	800	XVBZ04	XVBZ04A [6]
Support tube concealment cover	3.94	100		XVBC020
	15.75	400		XVBC030
	31.50	800		XVBC040
Wall mount bracket (metal)	For direct mounting on base unit or with tulip XVBC11 + tube XVBC0*		XVBC12	
Incandescent bulbs bayonet type BA 15d, 10 Watts	12 Vac/Vdc			DL1BLJ
	24 Vac/Vdc			DL1BLB
	48 Vac/Vdc			DL1BLE
	120 Vac/Vdc			DL1BLG
	230 Vac/Vdc			DL1BLM
Incandescent bulbs bayonet type BA 15d, 7 Watts	12 Vac/Vdc			DL1BEJ
	24 Vac/Vdc			DL1BEB
	48 Vac/Vdc			DL1BEE
	120 Vac/Vdc			DL1BEG
	230 Vac/Vdc			DL1BEM
Steady-On LED bulbs bayonet type BA 15d (sold as single) [7]	24 Vac/Vdc	White		DL1BDB1
		Green		DL1BDB3
		Red		DL1BDB4
		Blue		DL1BDB6
		Yellow		DL1BDB8
	120 Vac	Amber		DL1BDB5
		White		DL1BDG1
		Green		DL1BDG3
		Red		DL1BDG4
		Blue		DL1BDG6
Flashing LED bulbs	24 Vac/Vdc	White		DL1BKB1
		Green		DL1BKB3
		Red		DL1BKB4
		Amber		DL1BKB5
		Blue		DL1BKB6
	120 Vac	Yellow		DL1BKB8
		White		DL1BKG1
		Green		DL1BKG3
		Red		DL1BKG4
		Amber		DL1BKG5
Adapter for side entry through base unit	With CM12 (p. 13.5) cable gland, for cable size of 0.4 to 0.55 in. (10 to 14 mm) diameter		XVBC14	
	Conduit adapter		1/2 in. NPT (for customer supplied tubing)	
			XVBC00	

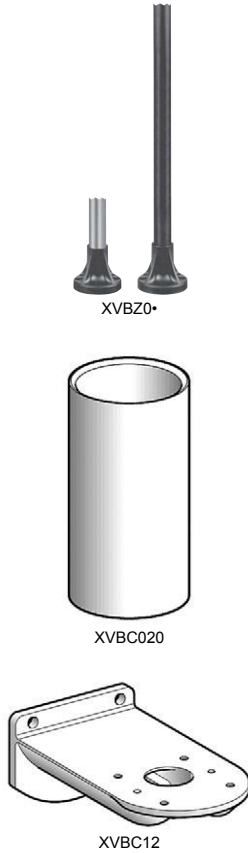
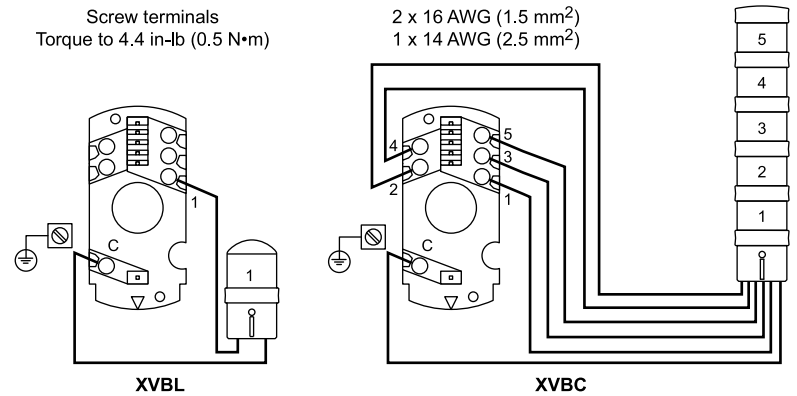

Table 19.366: XVB Markers and Legend Holders

Description	Characteristics	Catalog Number
Set of colored markers	6 colors	XVBC22
Set of 5 legend holders	Identification of stacked units on base	XVBC23

Wiring Diagrams, Base Units



[6] Aluminum tube.
[7] For 240 Vac, replace the B or G in the catalog number with M—for example, DL1BDM1. For flashing LEDs, refer to catalog 9001CT0001.

XVC Tower Lights and Accessories

Table 19.367: XVC4 Tower Lights — 40 mm diameter (1.5 inches)



Description	Light source (included)	Voltage	Signaling colors [8]		Catalog Number
			Steady	Flashing	
With support tube mounting					
Without buzzer	LED for steady light only	24 Vdc	R	—	XVC4B1
			R, O	—	XVC4B2
			R, O, G	—	XVC4B3
			R, O, G, B	—	XVC4B4
			R, O, G, B, C	—	XVC4B5
		100-240 Vac	R	—	XVC4M1
			R, O	—	XVC4M2
			R, O, G	—	XVC4M3
			R, O, G, B	—	XVC4M4
			R, O, G, B, C	—	XVC4M5
With buzzer + flashing light	LED for steady or flashing light [9]	24 Vdc	R	R	XVC4B15S
			R, O	R, O	XVC4B25S
			R, O, G	R, O, G	XVC4B35S
			R, O, G, B	R, O, G, B	XVC4B45S
			R, O, G, B, C	R, O, G, B, C	XVC4B55S
		100-240 Vac	R	R	XVC4M15S
			R, O	R, O	XVC4M25S
			R, O, G	R, O, G	XVC4M35S
			R, O, G, B	R, O, G, B	XVC4M45S
			R, O, G, B, C	R, O, G, B, C	XVC4M55S
For base mounting					
Without buzzer	LED for steady light only	24 Vdc	R	—	XVC4B1K
			R, O	—	XVC4B2K
			R, O, G	—	XVC4B3K
			R, O, G, B	—	XVC4B4K
			R, O, G, B, C	—	XVC4B5K

Table 19.368: Accessories for XVC4



Description	Diameter mm	Minimum height to be added mm	Catalog Number
Die-cast metal mounting base (for use with XVC4** and XVC4**5S with support tube)	90	32	XVCZ11
Plastic mounting base (for use with XVC4, XVC4** and XVC4**5S — customer must discard the support tube)	84	24.5	XVCZ01

Table 19.369: XVC Tower Lights — 100 mm diameter (4 inches)



Description	Light source (included)	Voltage Vdc	Signaling colors [8]		Catalog Number
			Steady	Flashing	
For base mounting					
Without buzzer With flashing light	LED for steady or flashing light [9]	24	R	R	XVC1B1K
			R, O	R, O	XVC1B2K
			R, O, G	R, O, G	XVC1B3K
			R, O, G, B	R, O, G, B	XVC1B4K
			R, O, G, B, C	R, O, G, B, C	XVC1B5K
		100-240 Vac	R	R	XVC1M1K
			R, O	R, O	XVC1M2K
			R, O, G	R, O, G	XVC1M3K
			R, O, G, B	R, O, G, B	XVC1M4K
			R, O, G, B, C	R, O, G, B, C	XVC1M5K
With buzzer + flashing light	LED for steady or flashing light [9]	24	R	R	XVC1B1SK
			R, O	R, O	XVC1B2SK
			R, O, G	R, O, G	XVC1B3SK
			R, O, G, B	R, O, G, B	XVC1B4SK
			R, O, G, B, C	R, O, G, B, C	XVC1B5SK
		100-240 Vac	R	R	XVC1M1SK
			R, O	R, O	XVC1M2SK
			R, O, G	R, O, G	XVC1M3SK
			R, O, G, B	R, O, G, B	XVC1M4SK
			R, O, G, B, C	R, O, G, B, C	XVC1M5SK

Table 19.370: Accessories for XVC1



Description	Diameter mm	Height mm	Catalog Number
Mount tube and base	140	300	XVCZ13
L-shape mount bracket	—	—	XVCZ23

[8] Signaling colors: R = Red, G = Green, O = Orange, B = Blue, C = Clear. The colors are listed in the mounting order of the illuminated units from top to bottom.

[9] Flashing light function selected by wiring or programming.



XVC 6B5K



XVC 6B55SK

Table 19.371: XVC6 Tower Lights, 60 mm diameter (2.375 inches)

Description	Light source (included)	Voltage	Signaling colors [10]		Catalog Number
			Steady	Flashing	
With support tube mounting					
Without buzzer	LED for steady light only	24 Vdc	R	–	XVC6B1
			R, O	–	XVC6B2
			R, O, G	–	XVC6B3
			R, O, G, B	–	XVC6B4
			R, O, G, B, C	–	XVC6B5
		100-240 Vac	R	–	XVC6M1
			R, O	–	XVC6M2
			R, O, G	–	XVC6M3
			R, O, G, B	–	XVC6M4
			R, O, G, B, C	–	XVC6M5
With buzzer + flashing light	LED for steady or flashing light [11]	24 Vdc	R	R	XVC6B15S
			R, O	R, O	XVC6B25S
			R, O, G	R, O, G	XVC6B35S
			R, O, G, B	R, O, G, B	XVC6B45S
			R, O, G, B, C	R, O, G, B, C	XVC6B55S
		100-240 Vac	R	R	XVC6M15S
			R, O	R, O	XVC6M25S
			R, O, G	R, O, G	XVC6M35S
			R, O, G, B	R, O, G, B	XVC6M45S
			R, O, G, B, C	R, O, G, B, C	XVC6M55S
For base mounting					
Without buzzer	LED for steady light only	24 Vdc	R	–	XVC6B1K
			R, O	–	XVC6B2K
			R, O, G	–	XVC6B3K
			R, O, G, B	–	XVC6B4K
			R, O, G, B, C	–	XVC6B5K
		100-240 Vac	R	–	XVC6M1K
			R, O	–	XVC6M2K
			R, O, G	–	XVC6M3K
			R, O, G, B	–	XVC6M4K
			R, O, G, B, C	–	XVC6M5K
With buzzer + flashing light	LED for steady or flashing light [11]	24 Vdc	R	R	XVC6B15SK
			R, O	R, O	XVC6B25SK
			R, O, G	R, O, G	XVC6B35SK
			R, O, G, B	R, O, G, B	XVC6B45SK
			R, O, G, B, C	R, O, G, B, C	XVC6B55SK
		100-240 Vac	R	R	XVC6M15SK
			R, O	R, O	XVC6M25SK
			R, O, G	R, O, G	XVC6M35SK
			R, O, G, B	R, O, G, B	XVC6M45SK
			R, O, G, B, C	R, O, G, B, C	XVC6M55SK



XVC Z02



XVC Z12

Table 19.372: Accessories for XVC6

Description	Diameter mm	Minimum height to be added mm	Catalog Number
Die-cast metal mounting base for XVC6B• and XVC6B•5S with support tube.	100	30	XVCZ02
Stamped metal mounting base for XVC6B• K and XVC6B•5SK	84	21.6	XVCZ12

[10] Signaling colors: R = Red, G = Green, O = Orange, B = Blue, C = Clear. The colors are listed in the mounting order of the illuminated units from top to bottom.

[11] Flashing light function selected by wiring or programming.

New!

XVU 60 mm Diameter Tower Lights Description

The XVU tower lights are customer assembled products comprising:

1. Top cover (Black or Silver)
2. Buzzer unit (Black or Silver) [12]
3. Illuminated units: [13]
 - a. LED illuminated units (Colors: Green, Red, Orange, Blue, White or Yellow)
 - b. Multi-color LED unit (Colors: Green, Red, Orange, Blue, White or Yellow. Patterns: steady, blinking, flashing, or rotating)
4. Sound unit [14]
5. Body extender (Black or Silver)
6. DC body unit (Black or Silver)
7. AC body unit (Black or Silver)
8. Flexible mounting module
9. Direct mounting plate (Black or Silver)
10. 100 mm/3.937 in. pole with fixing plate (Black or Silver)
11. Height adjustment pole from 210 to 385 mm/8.268 to 15.157 in. [15]

Composition

- XVU tower lights are customer assembled signaling units that are mounted on the body of the unit with a mounting accessory.
- Maximum of 5 illuminated units or 4 illuminated units with 1 audible unit can be assembled. The illuminated or audible unit [16], stack vertically.
- With the indicator marks on these units they can be easily assembled.
- Electrical connections between each unit are made automatically as they are mechanically assembled.
- The signaling units are identical in size and their positioning is unrestricted.

Mounting

Fixed into support panel using direct mounting plate, 100mm/3.937 in. pole with mounting plate or adjustment pole.

Cabling

By means of spring cage connection terminal block incorporated in mounting unit (Direct mounting plate, pole with plate, adjustment pole)

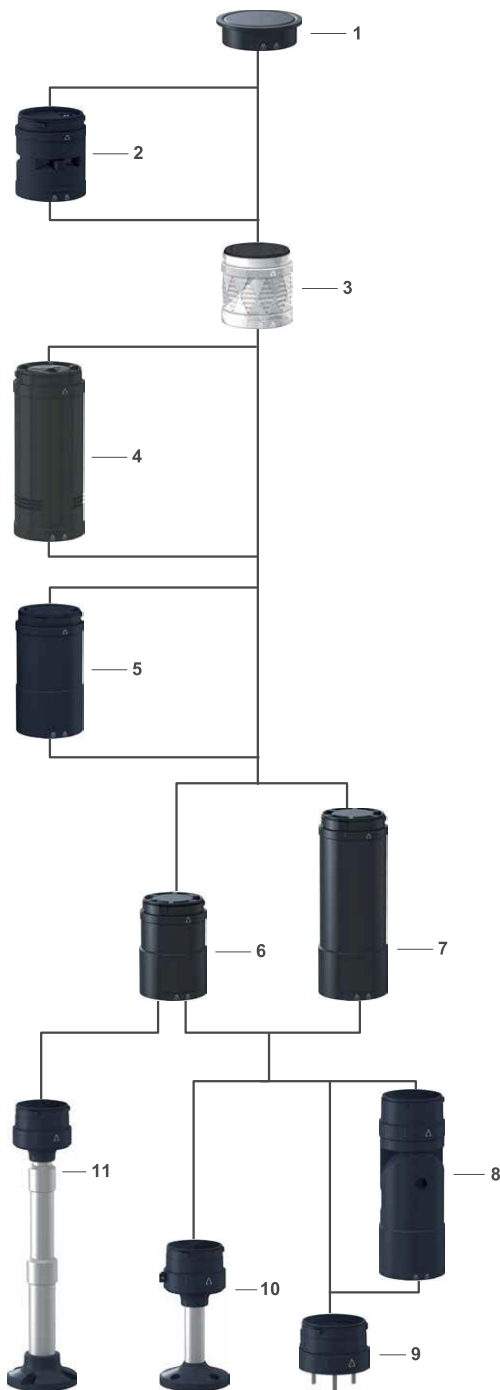

[12] Always mounted on the top

[13] Up to 5 LED illuminated units without sound module; Up to 4 LED illuminated units with sound module

[14] (3) Sound module can work without LED unit

[15] Only for DC body unit

[16] Sound module cannot be combined with buzzer unit at the same time.(5)

New!

XVU Illuminated LED Units: IP 65

Table 19.373: Illuminated LED Units: IP 65

Description	Signaling Type	Characteristics		Color	Catalog Number
		Voltage	Power		
High brightness LED units	Steady	24 V	2.5 W	Green	XVUC23
		24 V	2.0 W	Red	XVUC24
		24 V	2.0 W	Orange	XVUC25
		24 V	2.5 W	Blue	XVUC26
		24 V	2.5 W	White	XVUC27
		24 V	2.5 W	Yellow	XVUC28
	Steady/blinking/flashing/rotating	24 V	1.5 W	Multi-color (Green, Red, Orange, Blue, White and Yellow)	XVUC29



XVUC23



XVUC26



XVUC28



XVUC29

New!

XVU Audible Units: IP 54

Table 19.374: Audible units: IP 54

Description	Characteristics		Color	Catalog Number
	Voltage	Power		
Buzzer, adjustable 70–85 dB at 1 m/3.281 ft (4 configurations of audible signal)	24 V	1.7 W	Black	XVUC9S
			Silver	XVUC9SQ
Sound, adjustable 0–86 dB at 1m/3.281 ft (4 channels)	24 V	1.7 W	Black	XVUC9V



XVUC9S



XVUC9SQ



XVUC9V

New!

XVU Body Units: IP 65

Table 19.375: Body units: IP 65

Description	Voltage	Color	Catalog Number
Body unit with top cover [17]	~ 24 V	Black	XVUC21B
		Silver	XVUC21BQ
	~ 100 to 240 V	Black	XVUC21M [18]
		Black	XVUC21MP [19]
		Silver	XVUC21MQP [19]
		Silver	XVUC21MP [19]



XVUC21BQ



XVUC21M



XVUC020

New!

XVU Accessories

Description	Voltage	Color	Catalog Number
Body extender	~ 24 V	Black	XVUC020
		Silver	XVUC020Q
Direct mounting plate		Black	XVUZ01
			XVUZ03 [20]
		Silver	XVUZ04 [21]
			XVUZ01Q
Aluminium mounting plate with 100 mm/3.937 in. pole		Black	XVUZ02
		Silver	XVUZ02Q
Aluminium adjustment pole and mounting plate for height adjustment [22]		Black	XVUZ05
Flexible mounting element for use on horizontal or vertical support, IP 55		Black	XVUZ06



XVUC020Q



XVUC020



XVUZ01



XVUZ01Q



XVUZ05

[17] Direct mounting plate XVUZ01 • needed for direct mounting
 [18] NPN type
 [19] PNP type
 [20] Two-foot mounting
 [21] Four-foot mounting
 [22] (6) Only for use with DC body unit.

New!

XVGU Multi-color USB Tower Lights

The monolithic USB tower lights of the Harmony® XVGU range supports Magelis HMIs [23]. These tower lights with multi-color LEDs are unique and simple-to use as the states and patterns are directly set and modified in the HMI application.

The XVGU tower lights provide long distance indication of the operating status or sequences of a machine or installation, both visually by illuminated signaling units with 360° visibility, and audibly by a buzzer.

- The tower light comes with a pre-assembled USB cable for simple wiring and easy integration with the Magelis HMIs [23] [24]
- The tower light settings are selected from the Set screen of the HMI application at the time of integration.
 - The multi-color LEDs on the three levels can be set to numerous color combinations (red, orange, green or blue) for sophisticated signaling.
 - The 2-tone buzzer volume and alarm type (4 pre-recorded types) can be set easily.
- The tower lights allow to optimize your equipment: many customized configurations can be made from a sole product.
- The range involves Ø 60 mm/2.36 in. products and is therefore ideal for use in many activity sectors (textiles, packaging, baggage handling). It is also ideal for use with metal tools, plastic extrusion machines and assembly lines. This range is only for indoor applications

NOTE: Signaling colors correspond to a combination of 4 colors (red, orange, green, and blue) which can be set easily in the HMI application.



Magelis HMIs [23]



XVGU3SHAV



XVGU3SWV

Table 19.376: Pre-assembled tower lights --- 5 V, 60 mm/2.36 in. Dia.

Description	Light Source (included)	Compatible with terminals [25]	Catalog Number
Tower light composed of 100 mm/3.94 in. aluminium tube mounting, fixing plate and buzzer	Multi-color LED for various states and patterns (red, orange, green, or blue)	XBTGT (except GT1000 series) XBTGC (with SoMachine platform) XBTGK HMIGTO HMIGXO HMISCU	XVGU3SHAV
Tower light composed of direct base mounting and buzzer	Multi-color LED for various states and patterns (red, orange, green, or blue)	XBTGT (except GT1000 series) XBTGC (with SoMachine platform) XBTGK HMIGTO HMIGXO HMISCU	XVGU3SWV

Table 19.377: Accessories

Description	Function	Length	Catalog Number
Connection cable from PC to the terminal (USB Type A/mini B)	Cable for transferring screen data from a PC (USB Type A) to a HMI (USB Type mini B)	1.8 m/5.91 ft	BMXXCAUSB018



BMXXCAUSB018

[23] Compatible with XBTGT (except GT1000 series), XBTGC (with SoMachine platform), XBTGK and HMIGTO terminals.

[24] For extension, use either the Schneider Electric USB cable (BMXXCAUSB018) or a third-party USB Type A/mini B cable of maximum length 4 m/13.12 ft.

[25] Compatible with Vijeo Designer HMI configuration software V6.1, Service pack 1.

XVR Pre-Wired Beacons and Accessories
Table 19.378: XVR Pre-Wired Rotating Mirror Beacons



Diameter (mm)	Sound Option	Enclosure Rating	Voltage	Color	Catalog Number
Ø 84	Without buzzer	IP 23 (IP 65 with accessories)	12 Vac/Vdc	Red	XVR08J04
				Orange	XVR08J05
				Green	XVR08J03
				Blue	XVR08J06
			24 Vac/Vdc	Red	XVR08B04
				Orange	XVR08B05
				Green	XVR08B03
				Blue	XVR08B06
Ø 106	Without buzzer	IP 23 (IP 55 with accessories)	12 Vac/Vdc	Red	XVR10J04
				Orange	XVR10J05
				Green	XVR10J03
				Blue	XVR10J06
			24 Vac/Vdc	Red	XVR10B04
				Orange	XVR10B05
				Green	XVR10B03
				Blue	XVR10B06
Ø 120	Without buzzer	IP 23	12 Vac/Vdc	Red	XVR12J04
				Orange	XVR12J05
				Green	XVR12J03
				Blue	XVR12J06
			24 Vac/Vdc	Red	XVR12B04
				Orange	XVR12B05
				Green	XVR12B03
				Blue	XVR12B06
Ø 120	With buzzer	IP 23	12 Vac/Vdc	Red	XVR12J04S
				Orange	XVR12J05S
				Green	XVR12J03S
				Blue	XVR12J06S
			24 Vac/Vdc	Red	XVR12B04S
				Orange	XVR12B05S
				Green	XVR12B03S
				Blue	XVR12B06S
Ø 130	Without buzzer	IP 23 Resistant to vibration	12 Vdc	Red	XVR13J04
				Orange	XVR13J05
			24 Vdc	Red	XVR13B04
				Orange	XVR13B05

Table 19.379: XVR Accessories



Description	Diameter (mm)	Height (mm)	Catalog Number
Reflecting prism	84	—	XVRZR1
	106	—	XVRZR2
	120/130	—	XVRZR3
Rubber base to increase the IP degree of protection	84	—	XVRZ081
	106	—	XVRZ082
Mount tube and base	106, 120 and 130	300	XVCZ13
L-shape mounting bracket	84, 106 and 120	—	XVCZ23

XVS Sirens and Electronic Alarms

Table 19.380: XVS Sirens and Electronic Alarms

Description	Voltage	Color	Catalog Number
Multisound siren 105 dB, 43 tones	12/24 Vdc	White	XVS14BMW
Electronic alarms 90 dB, 16 tones Panel Mount DIN72	12/24 Vac/Vdc	PNP, Black	XVS72BMBP
		PNP, White	XVS72BMWP
		NPN, Black	XVS72MBN
		NPN, White	XVS72BMWN



XVS14BMW



XVS72BM

Table 19.381: XVS Dimensions (mm)

XVS 14BMW

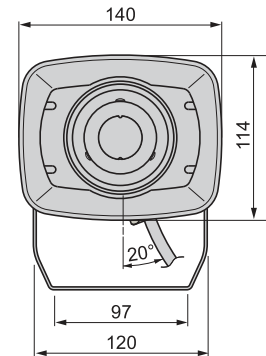
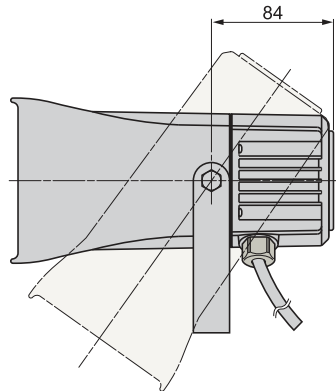
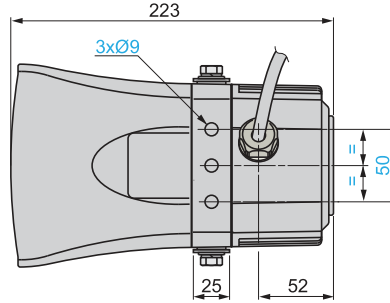

XVS 72BM●●

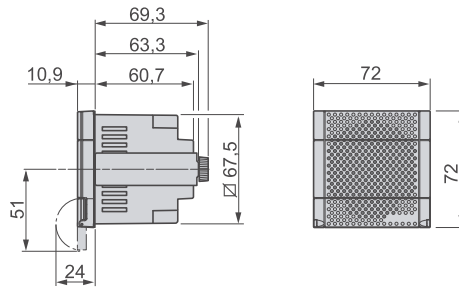

New!

Harmony eXLhoist Operator Control Stations

The Harmony® eXLhoist range of wireless remote control systems provide complete and innovative crane operator control solutions to: improve the machine and crane operator efficiency, enhance safety for people and equipment, and to reduce installation and maintenance downtime.

The remote control system XARS is a combination of remote control device (or transmitter: XART) and base station (or receiver: XARB), which transmits commands and information from the operator to the machine and vice versa by a wireless transmission means.

The XARS system offers movement in 3 directions (for example: hoist, bridge, and trolley) at 2 speed levels (low and high) for each movement.

The 2 modes available in the system are:

- Single mode: the remote control device controls one base station
- Tandem mode: the remote control device controls 2 base stations simultaneously.

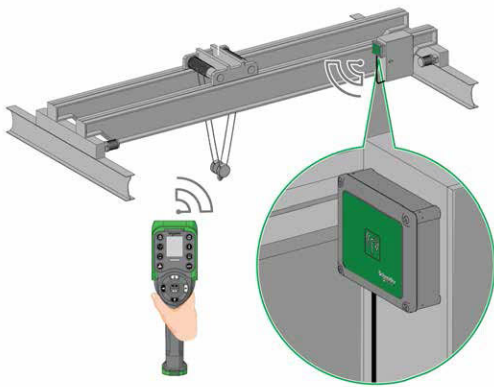

ZART8L



ZART8D



ZARB12H



ZARB18W



XARS12D18H

Table 19.382: Remote Control Devices

Description	Characteristics		Catalog Numbers
	Motion push buttons	Auxiliary push buttons	
With LEDs	6	2	ZART8L
With display	6	2	ZART8D
With display	6	6	ZART12D

Table 19.383: Base Station

Description	Characteristics		Power Supply (V)	Catalog Number
	Outputs	Inputs		
Wired connection cable gland	12 relays + 2 safety relays	—	~ 24–240	ZARB12W
Industrial plug connection	12 relays + 2 safety relays	—	~ 24–48	ZARB12H
Wired connection cable gland	18 relays + 2 safety relays	18 digital (12 limiters + 6 alarms)	~ 24–240	ZARB18W
Industrial plug connection	18 relays + 2 safety relays	18 digital (12 limiters + 6 alarms)	~ 24–48	ZARB18H

Table 19.384: Wireless Remote Control

Description	Characteristics		Catalog Number
	Special Functions	Connection	
Complete unit without charger device	—	Wiring	XARS8L12W (ZART8L + ZARB12W)
	—	Industrial plug	XARS8L12H (ZART8L + ZARB12H)
	Limiter protection Movement monitoring	Wiring	XARS8D18W (ZART8D + ZARB18W)
		Industrial plug	XARS8D18H (ZART8D + ZARB18H)
		Wiring	XARS12D18W (ZART12D + ZARB18W)
		Industrial plug	XARS12D18H (ZART12D + ZARB18H)

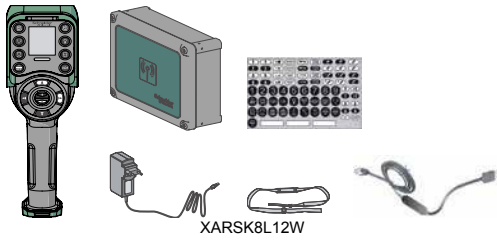
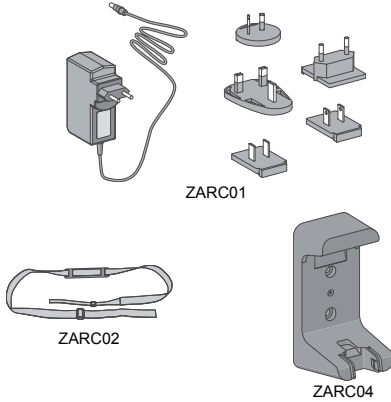

Table 19.385: Kits

Description	Components	Catalog Numbers
Starting kit comprising of Remote control system + accessories + USB/RJ45 cable + Configuration software	ZART8L + ZARB12W + ZARC01 + ZARC02 + TCSMCNAM3M002P	XARSK8L12W
	ZART8L + ZARB12H + ZARC01 + ZARC02 + TCSMCNAM3M002P	XARSK8L12H
	ZART8D + ZARB18W + ZARC01 + ZARC02 + TCSMCNAM3M002P	XARSK8D18W
	ZART8D + ZARB18H + ZARC01 + ZARC02 + TCSMCNAM3M002P	XARSK8D18H
	ZART12D + ZARB18W + ZARC01 + ZARC02 + TCSMCNAM3M002P	XARSK12D18W
	ZART12D + ZARB18H + ZARC01 + ZARC02 + TCSMCNAM3M002P	XARSK12D18H

Table 19.386: Accessories

Description	Characteristics	Catalog Number
Charger for remote device	~100–240 V power supply	ZARC01
Shoulder belt for remote device	2 m / 6.56 ft length	ZARC02
External antenna for Base station [1]	with 2 m / 6.56 ft cable and bracket included	ZARC03
Holder for remote device	104 x 239 mm / 4.09 x 9.41 in.	ZARC04
Connector plug female	with cable 1.5 m / 4.92 ft	ZARC05
Cable gland kit with wire grommets	1 x M25 + 1 x M20	ZARC06
Kit for adhesive labels for remote device	in Black and White	ZARC07
Kit for adhesive labels for remote device and crane equipment	Multi color	ZARC08
Mounting kit	Silent block + magnet and metal support	ZARC09
Connector plug (female)	with cable 3 m / 9.84 ft	ZARC12
Connector plug (female)	with cable 5 m / 16.40 ft	ZARC18
Connector cable	USB to RJ45	TCSMCNAM3M002P



[1] Use of this accessory allows to increase radio range in severe environment conditions.

Type BW Pendant Stations and Accessories

This pre-assembled, two-button station now comes complete with internal and external strain relief. Oversized finger grips on the rear of the enclosure make it easy to grip and operate.

- Well suited for standard hoist applications
- Push button legend inserts
- Field-installable mushroom button
- Full cover gasket, to exclude harmful contaminants

Table 19.387: BW90 and BW100 Pendant Stations – with cord connector and strain relief

Description	Legend Insert Markings	Mechanical Interlock	Enclosure Color			Contact Symbol	Replacement Interior [2]		
			Yellow	Black	Red		9001 Type	Contact Symbol	
 BW90 / BW100	Single Speed	Up-Down	Yes	BW92Y	BW92B	BW92R	146	BOC368	146
		Forward-Reverse	Yes	BW93Y	BW93B	BW93R	146	BOC368	146
		On-Off [3]	Yes	BW94Y	BW94B	BW94R	10	BOC358	147
		Start-Stop	No	BW95Y	BW95B	BW95R	145	BOC359	25
		Start-Stop [3]	Yes	BW96Y	BW96B	BW96R	10	BOC358	147
		On-Off [3]	No	BW97Y	BW97B	BW97R	146	BOC359	25
		Up-Down	Yes	BW98Y	BW98B	—	100	—	—
		without Inserts	Yes	BW90YU	BW90BU	BW90RU	147	BOC366	25
		without Inserts	No	BW91YU	BW91BU	BW91RU	25	BOC359	25
		without Inserts [3]	Yes	BW94YU	BW94BU	BW94RU	147	BOC358	147
	Two Speed	without Inserts	Yes	BW100YU	BW100BU	BW100RU	150	BOC367	150
		Up-Down	Yes	BW102Y	BW102B	BW102R	150	BOC367	150

Table 19.388: Hanger Brackets



Description	Form
 Y236	External Bracket (cannot be field installed) Y236
 B350	Bracket and Seal Kit B350

Table 19.390: Interchangeable Legend Inserts for Type BW Pendant Stations [4]

Marking	Type
Start	B259
Stop	B260
Forward	B255
Reverse	B256
Open	B263
Close	B264
Raise	B261
Lower	B262
Up	B253
Down	B254
On	B257
Off	B258
Blank - black	B251
Blank - red	B252

Table 19.389: Strain Relief Replacement

Description	Type
 BWSR	Strain Relief Replacement BWSR

Table 19.391: Replacement Enclosures

Description	Color	Type
Box & Cover with 4 screws	Yellow	BWRY
	Red	BWRR
	Black	BWRB

Table 19.392: Electrical Contact Ratings [5]

Volts	AC—NEMA B600					Continuous Carrying Amperes	Resistive 75% Power Factor Make, Break and Continuous Carrying Amperes	Volts	DC—NEMA P600	
	Inductive 35% Power Factor				Continuous Carrying Amperes				Inductive and Resistive	
	Make		Break						Make and Break Amperes	Continuous Carrying Amperes
120	30.5	3600	3.75	360	5	5	120	1.1	5	
240	15	3600	1.5	360	5	5	240	0.55	5	
480	7.5	3600	.75	360	5	5	600	0.2	5	
600	6	3600	.6	360	5	5				

Contact Symbols (Type BW Pendant Stations)

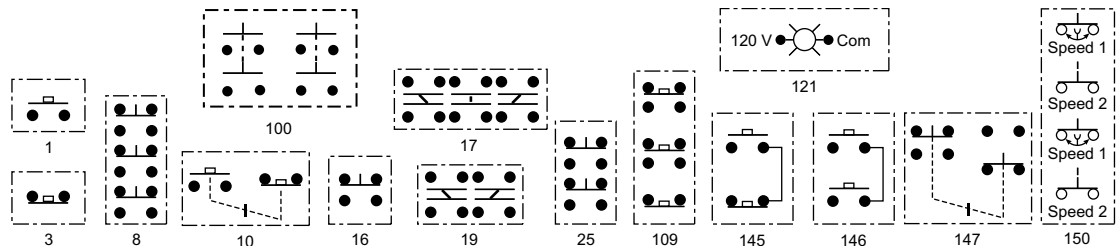

[2] Includes gasket
 [3] Maintained Contact
 [4] Order must specify a quantity of 10 or multiples of 10.
 [5] OSHA Regulation, Section 1910.70, Overhead and Gantry Cranes, limits the voltage of pendant push buttons to 150 Vac or 300 Vdc.

XAC Pistol Grip Stations and General Purpose Pendants

XAC pendant stations are designed for standard- or medium-duty control circuit applications.

- Single- or two-speed versions
- Double insulated
- Shock and corrosion resistant
- 2, 4, 6, 8, 12 element versions
- Ease of operation

Table 19.393: Pistol Grip Stations

Description	Speeds	Function		Catalog Number
		1 speed	2 speed	
1 N.O. contact per operator 2 Mechanically interlocked operators	1	↕		XACA201 [6]
2 N.O. (staggered) contacts per operator 2 Mechanically interlocked operators	2		↕	XACA207 [6]
1 N.O. + 1 N.C. 2 Mechanically interlocked operators	1	↕		XACA205 [6]
1 N.O. contact per direction 1 Mechanically interlocked 2 way toggle	1	↕		XACD21A0101 [7]
1 N.O. + 1 N.O. staggered 1 Mechanically interlocked 2 way toggle	2		↕	XACD21A1231 [7]
1 N.O. & 1 N.C. contact per direction 1 Mechanically interlocked 2 way toggle	1	↕		XACD21A0105 [7]
1 N.C. + 1 N.O. + 1 N.O. staggered 1 Mechanically interlocked 2 way toggle	2		↕	XACD21A1241 [7]

NOTE: Legends are required to achieve NEMA4 rating.



XACA201



XACA06



XACA03 with operators

Table 19.394: General Purpose Pendants [8][9]

Enclosures	Catalog Number
2 hole enclosure	XACA02H7
3 hole enclosure	XACA03H7
4 hole enclosure	XACA04H7
6 hole enclosure	XACA06H7
8 hole enclosure	XACA08H7
12 hole enclosure	XACA12H7

To place a custom pendant order, use the worksheet Type XACA Worksheet, page 19-131 as a guide. Orders must be placed through the Product Selector in Quote to Cash. There is a 10% charge for assembly.

XAC Contact Blocks

Table 19.395: Contact Blocks for Operators in Cover

Description	Wiring Diagram	Catalog Number
1 N.O./spring return/1 speed	—	ZB2BE101
1 N.C./spring return/1 speed	—	ZB2BE102
1 N.O. early close & 1 N.C. & 1 N.O./spring return/2 speed	Figure 1	XENG1191
1 N.C. & 2 N.O./spring return/1 speed	Figure 2	XENG1491
1 N.O. & 1 N.O. latching/1 speed/interlocked	Figure 3	XENG3781
1 N.O. & 1 N.C. latching/1 speed/interlocked	Figure 4	XENG3791
3 N.C.—all direct acting	Figure 5	XENT1192

Table 19.396: Contact Blocks for Operators in Base of Enclosure [10]

Description	Catalog Number
1 N.O./1 speed	XACS101
1 N.C./1 speed	XACS102
2 N.O./1 speed	XACS103
2 N.C./1 speed	XACS104
1 N.O. & 1 N.C./1 speed	XACS105

Wiring Diagrams

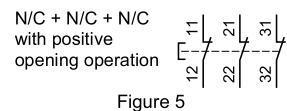
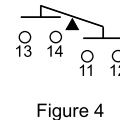
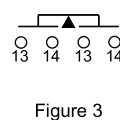
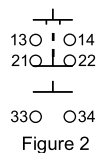
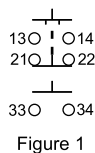

[6] These units are available with factory installed E-stops. Add a "3" to the end of the catalog number for standard E-stop or add a "4" for a trigger action E-stop.

[7] These units are available with a factory installed E-stop. Use XACD22 *** for a standard E-stop or XACD24*** for a trigger action E-stop.

[8] Standard enclosures include internal mounting plate, cable sleeve for 8 to 26 mm, internal cable clamp, suspension ring and cable tie.

[9] For ordering information on custom built XACA pendants, visit our website at www.Schneider-Electric.us.

[10] Cannot be used with XACA03 pendant.

XAC Operators and Accessories

Table 19.397: Operators [11]

Description	Color	Catalog Number
Booted push button	White	XACA9411
	Black	XACA9412
	Green	XACA9413
	Red	XACA9414
	Yellow	XACA9415
	Blue	XACA9416
	Brown	XACA9419



Table 19.398: Mushroom Operators

Description	Mushroom Size	Color	Catalog Number
Mushroom head, push to maintain/turn-to-release (trigger action)[12]	30 mm	Red	ZA2BS834
	40 mm	Red	ZA2BS844
Mushroom head, push to maintain/key turn-to-release (trigger action)[12]	40 mm	Red	ZA2BS944



Table 19.399: Selector Switches and Wobble Stick

Description	Color	Catalog Number
Selector switch/2 position—maintained[13]	Black	ZA2BD2
Selector switch/3 position—maintained[13]	Black	ZA2BD3
Selector switch/2 position—maintained key operated—key removal from LT or RT position[13]	NA	ZA2BG4
Selector switch/3 position—maintained key operated—key removal from LT or RT position[13]	NA	ZA2BG5
Wobble stick (bottom mounting recommended)	Black	ZA2BB2



Table 19.400: Pilot Light Components

Description	Color	Catalog Number
Direct supply base/without lamp (for 6 to 120 V applications) (AC/DC) [14]	—	ZB2BV006



Table 19.401: Enclosure Accessories

Description	Catalog Number
Blank hole plug	ZB2SZ3
Mechanical interlock (momentary). For use with XAC booted operators only	XACA009
Screw adapter for self-supporting cable	XACB961
Low suspension ring for single row station	XACA971
Protective guard for bottom mounted mushroom head	XACA982
Protective guard for bottom mounted selector switch or key switch	XACA983

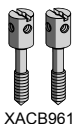
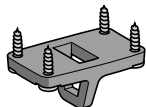

Table 19.402: Lamps, BA9s Base

Type	Voltage	Watts	Catalog Number
Replacement bulbs (Type BA9s) Incandescent	6 Vac/Vdc	1.2	DL1CB006
	12 Vac/Vdc	2.0	DL1CE012
	24 Vac/Vdc	2.0	DL1CE024
	48 Vac/Vdc	2.4	DL1CE048
	130 Vac/Vdc	2.6	DL1CE130

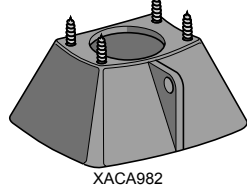
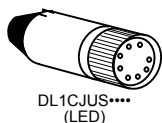
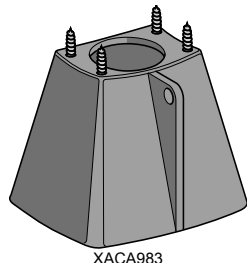

Table 19.403: LED, BA9s Base

Type	Color	Voltage	Catalog Number
LED, BA9s base for Direct Supply blocks	Green	6 Vac/Vdc	DL1CJUS0063
	Red	6 Vac/Vdc	DL1CJUS0064
	Amber	6 Vac/Vdc	DL1CJUS0065
	Green	24 Vac/Vdc	DL1CJUS0243
	Red	24 Vac/Vdc	DL1CJUS0244
	Amber	24 Vac/Vdc	DL1CJUS0245
	White	24 Vac/Vdc	DL1CJUS0241
	Blue	24 Vac/Vdc	DL1CJUS0246
	Green	120 Vac/Vdc	DL1CJUS1203
	Red	120 Vac/Vdc	DL1CJUS1204
	Amber	120 Vac/Vdc	DL1CJUS1205



[11] Booted push buttons are for cover mounting only. All other operators can be mounted on cover or bottom.
 [12] Trigger action mushroom heads are tamper proof in that a change of contact state is not possible by teasing or floating the operator.
 [13] Not for use with XENG contact blocks.
 [14] see Table 19.402 Lamps, BA9s Base, page 19-129 and Table 19.403 LED, BA9s Base, page 19-129.

Table 19.404: PVC Standard Legend Plates 30 x 40 mm

Text ^[15]	Catalog Number	Text ^[15]	Catalog Number	Text ^[15]	Catalog Number
Bridge Forward	ZB2BY2343	Left	ZB2BY2310	Stop	ZB2BY2304
Bridge Reverse	ZB2BY2344	Low	ZB2BY2336	Stop Start	ZB2BY2366
Close	ZB2BY2314	Lower	ZB2BY2337	Trolley Right	ZB2BY2345
Down	ZB2BY2308	Man Auto	ZB2BY2372	Trolley Left	ZB2BY2346
Emergency Stop	ZB2BY2330	Off	ZB2BY2312	Up	ZB2BY2307
Fast	ZB2BY2328	On	ZB2BY2311	Up Down	ZB2BY2370
Forward	ZB2BY2305	Off On	ZB2BY2367	Up-O-Down	ZB2BY2389
For Rev	ZB2BY2371	Open	ZB2BY2313	North	6516002379
For-O-Rev	ZB2BY2384	Open Close	ZB2BY2376	South	6516002380
Hand Off Auto	ZB2BY2387	Open-O-Close	ZB2BY2388	East	6516002381
High	ZB2BY2338	Out	ZB2BY2339	West	6516002382
High Low	ZB2BY2369	Power On	ZB2BY2326		
Hoist Down	ZB2BY2342	Raise	ZB2BY2335		
Hoist Up	ZB2BY2341	Reset ^[15]	ZB2BY2323		
In	ZB2BY2503	Reverse	ZB2BY2306		
Inch	ZB2BY2321	Right	ZB2BY2309		
Jog For	ZB2BY2381	Run	ZB2BY2334		
Jog Rev	ZB2BY2380	Slow	ZB2BY2327		
Jog Run	ZB2BY2365	Start	ZB2BY2303		

Type	Description	Background Color	Catalog Number
PVC blank legend	Blank	Black or red background—30 mm x 40 mm	ZB2BY2101
	Blank	Yellow or white background—30 mm x 40 mm	ZB2BY4101
PVC custom engraved	Special engraving ^[16]	Black background, white letters—30 mm x 40 mm	ZB2BY2002
	Special engraving ^[16]	White background, black letters—30 mm x 40 mm	ZB2BY4001

[15] All nameplates are black with white lettering except "Stop", "Emergency Stop" and "Reset" which are red with white lettering. For black "Reset" change final digit of catalog number to 2.

[16] Please specify lettering when ordering. Two lines with 11 characters (including spaces) maximum on each plate.

Type XACA Worksheet

Use this worksheet to assist in component selection. Custom orders for XACA pendant stations must be placed through the Product Selector in Quote to Cash. There is a 10% charge for assembly.

XACA Order Guide Instructions

Custom built pendant stations

1. Determine the number of operators needed, then choose an enclosure with a corresponding number of holes.
2. Select the type of operator, contact block, and appropriate nameplate for each function required.
3. Check for special functions that may be required. These items could include mechanical interlocks, adapters for self-supporting cable, lower support rings, protective guards, etc.

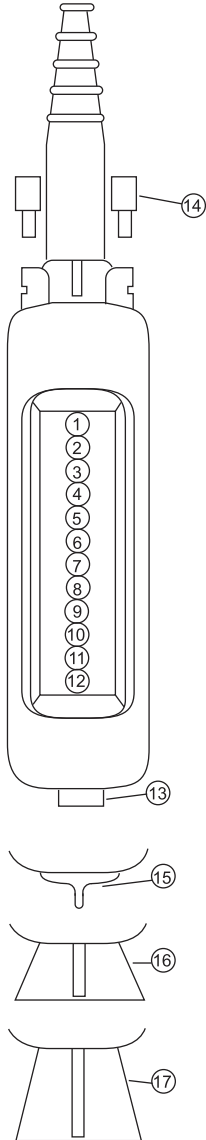

Mechanical Interlock (XACA009)

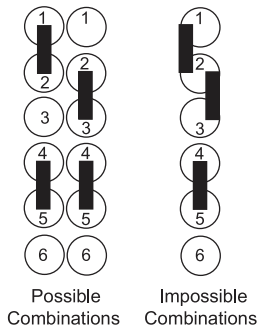

Functions (optional)	Catalog number of enclosure	XACA	<input type="checkbox"/>	<input type="checkbox"/>	<input type="checkbox"/>	<input type="checkbox"/>
	Mechanical interlock (draw a vertical line between the 2 units to be interlocked ▲)	Legends	Contact blocks and pilot light bodies	Push button Pilot light or Blanking plug		
	1					
	2					
	3					
	4					
	5					
	6					
	7					
	8					
	9					
	10					
	11					
	12					

▲ Mechanical interlock XACA009 Number of XACA009 required

Unit mounted in base of station (facing downwards)

	13			
--	----	--	--	--

Attachments

Position	Type	Catalog No.
14	Adapters for self-supporting cable type BBAP (available only with cable sleeve Ø8–26 mm)	XACB961
15	Lower support ring	XACA971
16	Protective guard for base mounted selector switch or 40 mm emergency-stop push button	XACA982
17	Protective guard for key switch	XACA983

Pendant Station Application and Ordering Information

This line of pendant stations consists of polymeric enclosures (2 through 10 units), push button units (1 through 5 speed) and laminated legend plates. All enclosures have an extra single unit space near the top which permits the installation of a toggle switch, a Type SK operator or pilot light, or a warning label. All enclosures come with a stainless steel hanger bracket and internal strain relief post. Enclosures are yellow and have a threaded opening in the top.

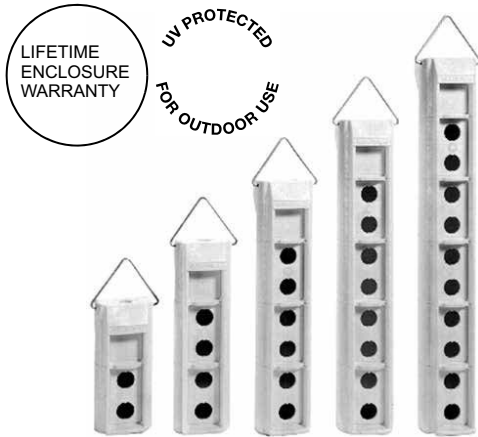
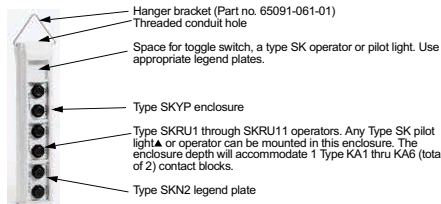

Table 19.405: Enclosure Catalog Numbers

Number of Buttons	Conduit Entrance Size	Enclosure Only [17]	Enclosure for Assembled Station [18]
		Catalog Number	Catalog Number
2	3/4"-14 NPT	SKYP2	SKYP20
4	3/4"-14 NPT	SKYP4	SKYP40
6	1"-11 1/2 NPT	SKYP6	SKYP60
8	1 1/4"-11 1/2 NPT	SKYP8	SKYP80
10	1 1/4"-11 1/2 NPT	SKYP10	SKYP100

Table 19.406: Push Button Units

Number of Buttons per Unit	Description	Contact Symbol	Catalog Number [19]
2	Single Speed – Momentary Interlocked	7	SKRU1[20]
2	Single Speed – Momentary Non-Interlocked	5	SKRU10[20]
2	Single Speed – Maintained Interlock	10	SKRU11[20]
2	Two Speed –Momentary Interlocked	87	SKRU2[21]
2	Three Speed – Momentary Interlocked	88	SKRU3[21]
2	Four Speed – Momentary Interlocked	89	SKRU4[21]
2	Five Speed –Momentary Interlocked	90	SKRU5[21]



▲ Class 9001 SK push-to-test pilot lights and remote test pilot lights will not fit in these enclosures.

Table 19.407: Legend Plate Catalog Numbers

	Where Used	Marketing	Catalog Number
	For SKRU1 through SKRU11	Blank-Blank	SKN200[22]
		Hoist: Up-Down Trolley: East-West Trolley: Fwd.-Rev. Trolley: North-South Bridge: Fwd.-Rev. Bridge: East-West Bridge: North-South Start-Stop Reset-Stop Aux Hoist: Up-Down Power: On-Off	SKN201 SKN202 SKN203 SKN204 SKN205 SKN206 SKN207 SKN208 SKN209 SKN210 SKN211
		Specify Marking	SKN299[22]
	With toggle switch [23] in top space of enclosure	Blank	SKN500 [24]
		Off-On On-Off	SKN544 [24] SKN545 [24]
		Specify Marking	SKN599 [24]
	With 9001SK [25] operator or pilot light in top space of enclosure	Blank	SKN100 [26]
		On Off Emerg. Stop Run Power On Off-On	SKN103 SKN104 SKN105 SKN124 SKN138 SKN144
		Specify Marking	SKN199 [26]

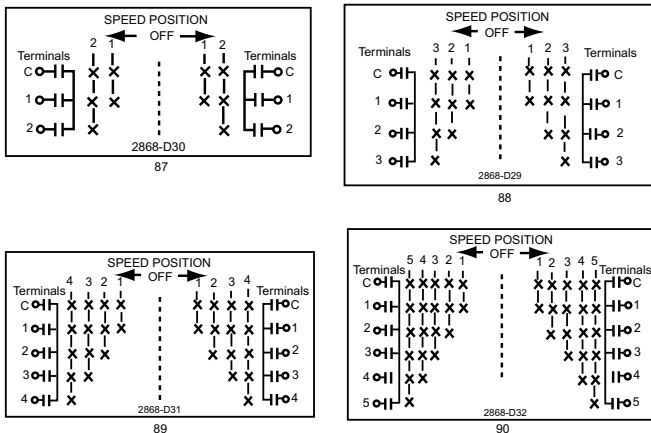

Figure 19.1: Multispeed Contact Symbols (X = Contact Closed)

Table 19.408: Closing Plate Catalog Number

	Catalog Number
	SK52

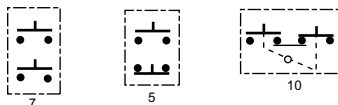

Figure 19.2: Single Speed Contact Symbols

[17] Class 9001 SK push-to-test pilot lights and remote test pilot lights will not fit in these enclosures.
 [18] Assembled pendant stations consist of an enclosure, operators and legend plates. All custom orders must include the pendant key sheet. See Type XACA Worksheet, page 19-131.
 [19] Types SKRU 1, 10 and 11 use Type KA contact blocks. Types SKRU 2 thru 5 are factory enclosed contact blocks.
 [20] Boot part number is 9001KU1.
 [21] Boot part number is 9001KU37.
 [22] 19 characters each side max.
 [23] Can be supplied by Square D as Class 9001 Type SKSTS1- includes boot for NEMA Type 4X.
 [24] Includes legend plate, gasket and ground plate to be used with toggle switch.
 [25] See 9001SK, page 19-82 through page 19-89
 [26] Tri-laminated legend plate having a yellow or red background on a black core.

Type SKYP Worksheet

	Control Products	Use this worksheet to assist in component selection. SKYP Custom Pendant orders must be placed through the Product Selector in Quote to Cash. There is a 10% charge for assembly.
		Class 9001 Type SKYP - _____

1. Operator or Closing Plate.
Example - SKRU1
2. Legend Plate Type Number
Example - SKN201
3. Legend Plate Marking ▲
– Used Only if Special Marking is Required
Example:
Line 2 - SKN299
Line 3 - A.) Hoist
 B.) FWD
 C.) REV

When operator and legend plate use 2 adjacent holes - specify same in both locations. Example:

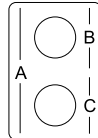

TYPE NUMBER KEY

1	SKRU1
2	SKN201
3	
1	SKRU1
2	SKN201
3	

ENCLOSURES – NEMA 4X, 13

Size	Conduit Entrance Size	Enclosure for Assembled Station ▲
		Catalog Number
2 Button	3/4" -14 NPT	SKYP20
4 Button	3/4" -14 NPT	SKYP40
6 Button	1" -14 NPT	SKYP60
8 Button	1 1/4" -11 1/2	SKYP80
10 Button	1 1/4" -11 1/2	SKYP100

▲ Assembled pendant stations consist of an enclosure, operators, and legend plates.

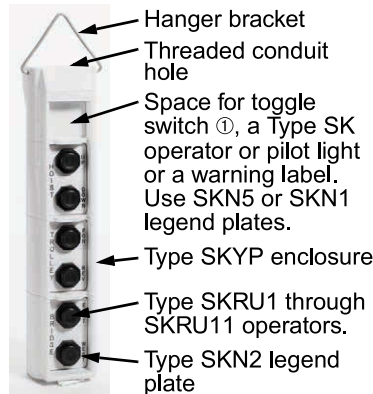

PUSH BUTTON UNITS – NEMA / UL 4X, 13

Number of Buttons per Unit	Description	Contact Symbol	Type
2	Single Speed - Momentary Interlocked	7	SKRU1
2	Single Speed - Momentary Non-Interlocked	5	SKRU10
2	Single Speed - Maintained Interlocked	10	SKRU11
2	Two Speed - Momentary Interlocked	87	SKRU2
2	Three Speed - Momentary Interlocked	88	SKRU3
2	Four Speed - Momentary Interlocked	89	SKRU4
2	Five Speed - Momentary Interlocked	90	SKRU5

CLOSING PLATE

Type
SK52

The price of the total station consists of the price of each individual component plus a 10% charge for assembly.

LEGEND PLATES – NEMA / UL 4X, 13

Where Used	Marking	Catalog Number
For SKRU1 through SKRU11	Blank-Blank	SKN200 ^④
	Hoist: Up-Down	SKN201
	Trolley: East-West	SKN202
	Trolley: Fwd.-Rev.	SKN203
	Trolley: North-South	SKN204
	Bridge: Fwd.-Rev.	SKN205
	Bridge: East-West	SKN206
	Bridge: North-South	SKN207
	Start-Stop	SKN208
	Reset-Stop	SKN209
Specify Marking	SKN299 ^④	
With Toggle Switch ① in Top Space of Enclosure	Blank	SKN500 ^②
	Off-On	SKN544 ^②
	On-Off	SKN545 ^②
	Specify Marking	SKN599 ^②
With Type SK Operator ▲ or Pilot Light in Top Space of Enclosure	Blank	SKN100 ^③
	On	SKN103
	Off	SKN104
	Emerg. Stop	SKN105
	Run	SKN124
	Power On	SKN138
	Off-On	SKN144
	Specify Marking	SKN199 ^③
	Specify Marking (Red Background)	SKN199R ^③

- ① Available as 9001SKSTS1
- ② Includes legend plate, gasket and ground plate to be used with toggle switch.
- ③ Tri-laminated legend plate having a yellow or red background on a black core.
- ④ 19 characters each side.
- ▲ Class 9001 Type SK Push-To-Test Pilot lights and Remote Test Pilot lights will not fit in these enclosures.

Space for toggle switch ①, a Type SK operator or pilot light, or a warning label. Use SKN-5 or SKN-1 legend plates.

Type SKRU1 through SKRU11 operators or Type SK operators and Type SKN-2 legend plate.

Heavy Duty Industrial Foot Switches—Oiltight, Watertight, Dusttight and Driptight Enclosure, NEMA 2, 4 and 13

⚠ DANGER

HAZARDOUS APPLICATIONS

Do not use foot switches on machines without point-of-operation protection.

Failure to follow these instructions will result in death, serious injury, or equipment damage.



AW2
Type AW Foot Switch with Top Pedal Shield and Side Shields



AW132
Type AW with Oversized Pedal Shield and Side Shields



AW117
Type AW with Oversized Pedal Shield, Side Shields and Safety Door



AW1
Type AW Foot Switch without Pedal Shield



AW124

Type AW Fully Shielded Foot Switch with Oversized Pedal Shield, Side Shields and Safety Door. The Safety Door is interlocked with the pedal to prevent operation due to shock or vibration. It prevents accidental pedal operation by requiring a simple but intentional motion to lift the door before inserting the foot.

Operating Temperature:
-30 to +60 °C (-22 to +140 °F)

Foot Switch Selection

Foot switches are used to control many industrial processes, while leaving the operator's hands free to perform other functions. The type or model of foot switch suitable for each application will vary depending on factors such as the control function required, degree of protection required, production methods, unusual conditions, government regulations, etc. In some applications more than one foot switch may be required, as when two or more persons are operating a machine. In these cases, safe practice and regulations require that the foot switches be wired in series making it necessary that each operator's foot switch be actuated before the machine will cycle.

Only the user can be aware of all the conditions and factors present during setup, operation and maintenance of the machine; therefore, only the user can determine which foot switch(es) can be properly used. When selecting a foot switch for a particular application, the user should refer to the applicable ANSI standards and OSHA regulations. The National Safety Council's Accident Prevention Manual also provides much useful information.

In some applications, such as power presses, additional operator protection such as point-of-operation guarding must be provided when a foot switch is used as an actuator. This is necessary since the operator's hands and other parts of the body are free to enter the pinch point area and serious injury can occur. The shielding provided on foot switches cannot protect an operator from injury. For this reason the foot switch cannot be substituted for or take the place of point-of-operation protection.

A Trilingual Danger Sign regarding the need for point-of-operation protection is supplied with each foot switch. The sign incorporates three languages: English, Spanish and French. Additional copies of the sign are available by contacting your Square D sales office.

Table 19.409: Foot Switch Catalog Numbers [1]

Description	Features	Fully Shielded with Oversized Pedal Shield, Side Shields and Safety Door	With Oversized Pedal Shield and Side Shields	With Pedal Shield and Side Shields	UNSHIELDED (See Warning note[2])
		Catalog Number	Catalog Number	Catalog Number	Catalog Number
Single Pole [3] Double Throw	Spring Return With Mechanical Latch	AW117 —	AW132 —	AW2 AW7	AW1 —
Two Pole [3] Double Throw	Spring Return With Mechanical Latch	AW124 [4] —	AW133 —	AW14 AW15	AW13 —
Two Stage [3] (One Pole Each Stage) Table 1	Spring Return With Mechanical Latch in 1st Stage With Mechanical Latch in 2nd Stage	AW119 — —	AW134 — —	AW6 AW9 AW10	AW5 — —
Four Stage [3] (One Pole Each Stage) Table 2	Spring Return	AW123	—	AW22	AW21
Single Pole Single Throw	Maintained Contact—Push On/Push Off	—	—	AW12	AW11
Replacement Cover Assembly	—	AC5	AC7	AC8 [5]	AC1



File: E42259
CCN: NKCR



File: LR25490
Class: 184 N 13.1U

For replacement parts for Class 9002 Type AW: See instruction bulletin 65013-010-31.

Also see Table 19.411 Contact Symbol—Two Stage, page 19-135 and Table 19.412 Contact Symbol—Four Stage, page 19-135.

[1] When ordering, add prefix "9002" to the catalog number.

[2] WARNING: These foot switches must not be used to operate machines or equipment where the possibility of operator injury exists. Typical uses include Emergency Stop functions, "Dead Man" controls, signal functions (lights, bells, etc.).

[3] A single pole snap switch that contains two double break contact elements (1 N.O. and 1 N.C.) must be used on circuits of same polarity. A double pole snap switch contains two electrically separated sets of contact elements allowing use on circuits of opposite polarity. Each set that contains two double break contact elements (1 N.O. and 1 N.C.) must be used on circuits of same polarity.

[4] 2 N.O. and 2 N.C. isolated, direct acting contacts.

[5] For replacement cover drilled to accept latch. For Series C foot switches order AC9. No replacement cover available for Series A or B devices drilled to accept latch. AC8 is spring return only.

Approximate Dimensions

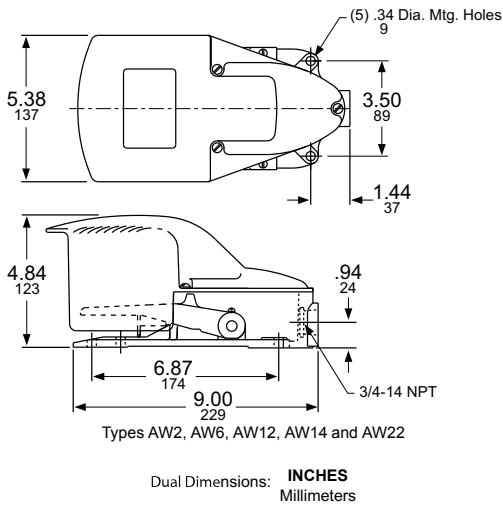
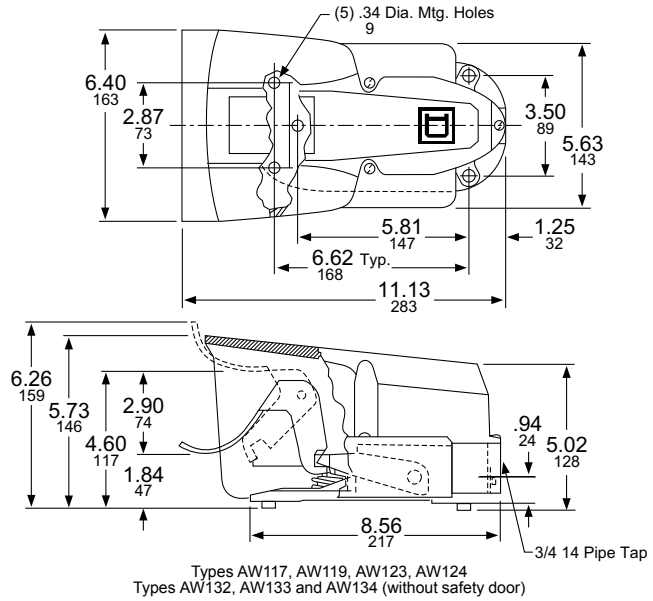
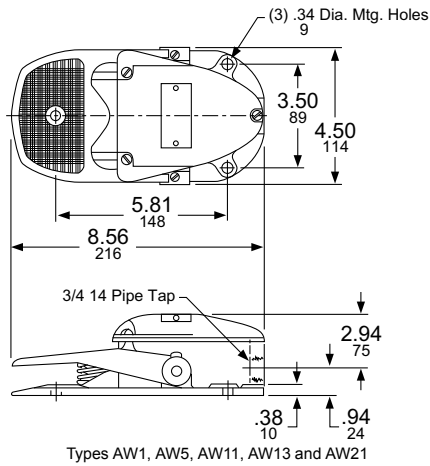

Table 19.410: Maximum Current Ratings For Control Circuit Contacts

Type	Volts	AC Amperes			Volts	DC Amperes		
		Inductive 35% Power Factor		Resistive 75% Power Factor		Inductive and Resistive		
		Make	Break			Make, Break and Continuous	Make and Break	Continuous
					Single Throw	Double Throw		
AW1 through AW10, AW117, AW119, AW132	120	40	15	15	125	2.0	0.5	15
	240	20	10	10	250	0.5	0.2	15
	480	10	6	6	600	0.1	0.02	15
	600	8	5	5				
AW13, AW14, AW15, AW133	120	30	3	3	125	1.0	0.2	10
	240	15	1.5	1.5	250	0.3	0.1	10
	480	7.5	0.75	0.75	600	0.1	—	10
	600	6	0.6	0.6				
AW11, AW12	115	36	6	—	125	2.2	—	—
	230	18	3	—	250	1.1	—	—
AW21, AW22, AW123	120	15.0	1.5	10	—	—	—	—
	240	7.5	0.75	10	—	—	—	—
	480	3.75	0.375	10	—	—	—	—
	600	3.0	0.3	10	—	—	—	—
AW124	120	60	6	10	120	1.1	—	10
	240	30	3	10	240	0.55	—	10
	480	15	1.5	10	600	0.2	—	10
	600	12	1.2	10				

NOTE: Double throw switches are rated 250 Vdc maximum.

Table 19.411: Contact Symbol—Two Stage

Unit	Snap Switch	Pedal		
	Circuit	Up	Half Down	Full Down
1	A1	0	1	1
	B1	1	0	0
2	A2	1	1	0
	B2	0	0	1

NOTE: 0 = Open 1 = Closed

Table 19.412: Contact Symbol—Four Stage

Unit	Snap Switch	Pedal Position			
	Circuit	Up → Down			
1	1A1	0	0	1	1
	1B1	1	1	0	0
	2A1	0	1	1	1
	2B1	1	0	0	0
2	1A2	1	1	1	0
	1B2	0	0	0	1
	2A2	1	1	1	0
	2B2	0	0	0	1

Type K Rotary Cam Switches

Applications		Used in building control panels and consoles, Type K cam switches allow control of processes and utilities in industry and buildings, and direct control for simple machines.							
									
Functions	Off-On/On-Off switches	1 to 6-pole			1 to 6-pole				
	Stepping switches	2 to 12-position, 1 to 4-pole			—				
	Changeover switches	1 to 5-pole			1 to 4-pole				
	Measurement switches	Voltmeter and ammeter			—				
	Reversing switches	2 and 3-pole			2 and 3-pole				
	Reversing star-delta switches	Star-delta			Star-delta				
	Pole change switches	2 and 3-speed			2-speed				
Conventional rated thermal current (Ith)		20 A	32 A	50 A	63 A	115 A	150 A		
Electrical operating characteristics		690 V	690 V	690 V	690 V	690 V	690 V		
		AC-3 - 3-phase	AC-3 - 3-phase	AC-3 - 3-phase	AC-3 - 3-phase	AC-3 - 3-phase	AC-3 - 3-phase		
		230 V - 2.2 kW - 8.3 A	230 V - 5.5 kW	230 V - 7.5 kW	230 V - kW	230 V - 5 kW	230 V - 22 kW		
		AC - 15	AC - 15	AC - 15	—	—	—		
		230 V - 4 A	230 V - 14 A	230 V - 6 A	—	—	—		
Front plate degree of protection		IP 40			IP 40				
Product Composition		Complete switches and custom adaptable sub-assemblies			Complete switches				
Compatibility		Ø 22 control and signalling units			—				
Mounting	Front Mounting	Multi-fixing Single Ø 22 hole			By 4 holes on 48 mm centers		By 4 holes on 68 mm centers		
	Rear Mounting	Screw fixing, 4 holes on 36 mm centers			Screw fixing, 4 holes on 48 mm centers		Screw fixing, 4 holes on 68 mm centers		
Front plate dimensions (mm)		45 x 45 60 x 60 (adaptable sub-assemblies)			64 x 64		88 x 88		
Operating heads		Black and red standard and long handles			Black standard handle Metallic legend, black marking				
		Key operator							
		Metallic head							
		Metallic legend with black marking or black legend with white marking							
		—							
Approvals		UL-CSA EN/IEC 60947-3 EN/IEC 60947-5-1			cULus EN/IEC 60947-3				
Type		Type K2			Type K30–K150				
Cam switch model [1]		Class 9003, K2			K30	K50	K63	K115	K150

Instructions for 9003K2 Key Sheet

The Key Sheet for ordering a 9003K2 cam switch is on page 19-137, and an example of a completed key sheet is on page 19-138. The instructions below are for filling out the key sheet on page 19-137.

- Select the box for K2 (20 A).
- Identify the Product quantity in the box provided.
- Verify front mounting by selecting the box: Front Mounting.
- If ordering a base/contact block only, select 22 mm plastic or 22 mm metal mounting. Then complete the following:
 - Switching Angle (positions)
 - Contact scheme and jumpers (pre-wired)
- If ordering a complete switch (base/contact block, head, legend), check the box. Then complete the following:
 - Operating head preference
 - Legend preference
 - Switching angle (positions)
 - Contact scheme and jumpers (pre-wired)
- Operating head preference ① (identify the operating head preferred)
- Legend preference ② (identify the legend preference)
- Switching angle (positions) ③ and special legend marking
 - Identify whether the switch need is 30° or 60°, or 45° or 90° switching angle.
 - Fill in the legend markings desired at the positions indicated. Zero degrees is always straight up.
- The rotation of the operator stops clockwise at the top or 0° position. If full rotation through 360° is desired, the Full rotation through 360° box must be checked.
- Contact scheme and jumpers (pre-wired) ④
 - If jumpers are desired to be pre-wired, draw a horizontal line between the terminals to be jumpered per the example on page 19-138.
 - Refer to the Legend at the bottom of page 19-137 for contact sequences, i.e.: X indicates contact closure. See page 19-138 for examples of filling in this portion of the key sheet.

[1] Incomplete part numbers. Contact your local supplier for assistance.

9003K2 Cam Switch Order Form—Example

<p>Order No. _____ Date : _____</p> <p>Agency: _____</p> <p>Branch: _____</p> <p>Customer: _____</p> <p>Address: _____</p> <p>Delivery instructions: _____</p> <p>Product reference: Type : K.....</p> <p>③ Switching angle (positions) 30° or 60° 45° or 90°</p> <p>Full rotation through 360°: <input type="checkbox"/></p>	<p>9003K2 (20 A): <input checked="" type="checkbox"/></p> <p>Product quantity: <input type="text" value="1"/> Front mounting <input checked="" type="checkbox"/></p> <p>Base/contact block only (no operating head): ∅ 22 plastic: <input type="checkbox"/> ∅ 22 metal: <input type="checkbox"/> Complete: <input type="text" value="3"/> <input type="text" value="4"/></p> <p>Complete switch (base/contact block, head, legend) <input checked="" type="checkbox"/> Complete: <input type="text" value="1"/> <input type="text" value="2"/> <input type="text" value="3"/> <input type="text" value="4"/> For 22 mm plastic mounting: _____</p> <p>① Operating head reference: 9003KAC1B</p> <p>② Legend reference: 9003KZ18 or for mounting with metal base: _____</p> <p>① Operating head reference: KAX Z.....</p> <p>② Legend reference: XBC Y</p> <p>Special legend marking: As per diagram on left: <input type="checkbox"/> As per form: <input type="checkbox"/> FAX</p> <p>Accessories / comments: KZ 36.....</p>
---	--

④ Contact scheme and jumpers (pre-wired):

		1	3	5	7	9	11	13	15	17	19	21	23	25	27	29	31	33	35	37	39			2	4	6	8	10	12	14	16	18	20	22	24	26	28	30	32	34	36	38	40

*	x	↙	1	3	5	7	9	11	13	15	17	19	21	23	25	27	29	31	33	35	37	39
			2	4	6	8	10	12	14	16	18	20	22	24	26	28	30	32	34	36	38	40
A		330°		x		x																
0		0°		x			x															
1		30°			x			x														
2		60°	x		x	x																

↙ (x) Key withdrawal position for key operators; by default, withdrawal in all positions.

Conditions for provision of spring return function:
R, Spring return to 30° from 0° position or to last position after a 90° angle (for maximum of 3 contacts simultaneously)

<input checked="" type="checkbox"/>	Contact closed in 1 position.	<input checked="" type="checkbox"/>	Contact closed with break between the 2 positions (for angle >= 45°)	<input checked="" type="checkbox"/>	Contact closed and maintained between several successive positions	<input checked="" type="checkbox"/>	Contact closed and maintained between two positions	<input checked="" type="checkbox"/>	Overlap of two contacts between two positions	<input checked="" type="checkbox"/>	Contact overlapping on previous and next positions
-------------------------------------	-------------------------------	-------------------------------------	--	-------------------------------------	--	-------------------------------------	---	-------------------------------------	---	-------------------------------------	--

Check the box to confirm selection Fill in with text